

**AIRPORT USE AND LEASE AGREEMENT**

**Between**

**CITY AND COUNTY OF DENVER**

**and**

**AMERICAN AIRLINES, INC.**

**at**

**DENVER INTERNATIONAL AIRPORT**

**FOR A TERM OF FIVE (5) YEARS**

**BEGINNING JANUARY 1, 2012**

# TABLE OF CONTENTS

<b>PART I</b> .....	<b>1</b>
DEFINITIONS .....	1
1.01 “AFFILIATED AIRLINE” .....	1
1.02 “AIRFIELD AREA FACILITIES” .....	1
1.03 “AIRPORT RULES AND REGULATIONS” .....	2
1.04 “BAGGAGE SYSTEM” .....	2
1.05 “DEMISED PREMISES” .....	2
1.06 “FISCAL YEAR” .....	2
1.07 “GENERAL BOND ORDINANCE” .....	2
1.08 “MANAGER” .....	2
1.09 “PREFERENTIAL USE FACILITIES” .....	2
1.10 “SIGNATORY AIRLINE” .....	3
<b>PART II</b> .....	<b>3</b>
AIRFIELD AREA FACILITIES .....	3
2.01 AIRFIELD AREA FACILITIES TO BE PROVIDED .....	3
2.02 USE OF AIRFIELD AREA FACILITIES .....	3
2.03 RAMP SERVICES .....	4
2.04 RATES, FEES AND CHARGES FOR THE USE OF THE AIRFIELD AREA FACILITIES .....	4
<b>PART III</b> .....	<b>5</b>
LEASE AND USE OF DEMISED PREMISES AND PREFERENTIAL USE FACILITIES .....	5
3.01 DEMISED PREMISES .....	5
3.02 USE OF DEMISED PREMISES .....	5
3.03 EFFICIENCY-IN-USE .....	6
3.04 PAYMENT OF FIXED AND VARIABLE RATES, FEES AND CHARGES .....	6
3.05 USE OF PREFERENTIAL USE FACILITIES ON CONCOURSES .....	6
3.06 USE OF AND ACCESS TO BAGGAGE SYSTEM .....	8
3.07 USE OF PUBLIC AREAS .....	8
<b>PART IV</b> .....	<b>9</b>
PROVISIONS RELATING TO AIRFIELD AREA FACILITIES, PREFERENTIAL USE FACILITIES, DEMISED PREMISES, AND JOINT USE FACILITIES .....	9
4.01 MAINTENANCE .....	9
4.02 AIRLINE ALTERATIONS TO DEMISED PREMISES .....	9
4.03 SUB-LETTING, ASSIGNMENT AND GROUND HANDLING ARRANGEMENTS .....	10
4.04 RIGHT TO ENTER AND MAKE REPAIRS .....	10
4.05 ABANDONMENT OF DEMISED PREMISES .....	11
4.06 DESTRUCTION OF PREMISES .....	11
4.07 COMMON USE SYSTEMS .....	11
4.08 REASSIGNMENT OF DEMISED PREMISES AND PREFERENTIAL USE FACILITIES .....	12
<b>PART V</b> .....	<b>12</b>
GENERAL PROVISIONS .....	12
5.01 AGREEMENTS WITH THE UNITED STATES .....	12
5.02 BOND ORDINANCES .....	12
5.03 LAWS, REGULATIONS, AND AGREEMENTS TO BE OBSERVED .....	12
<b>PART VI</b> .....	<b>13</b>
RATE-MAKING PROCEDURES AND REESTABLISHMENT .....	13
6.01 GENERAL PROVISIONS .....	13
6.02 NON-AIRLINE REVENUE .....	14
6.03 PROJECTION OF RENTALS, RATES, FEES AND CHARGES .....	14
6.04 MID-YEAR REVIEW OF RENTALS, RATES, FEES AND CHARGES .....	14
6.05 FINAL AUDIT .....	15
6.06 PASSENGER FACILITY CHARGES .....	15
<b>PART VII</b> .....	<b>15</b>
TERM OF THE AGREEMENT .....	15
7.01 TERM OF AGREEMENT .....	15
7.02 TERMINATION OF LEASE BY CITY .....	15
7.03 TERMINATION OF LEASE BY AIRLINE .....	17
7.04 EFFECTIVE DATE OF TERMINATION .....	17
7.05 SURRENDER AND HOLDING OVER .....	18

7.06 TERMINATION OF HOLDOVER .....	18
<b>PART VIII.....</b>	<b>18</b>
PERFORMANCE BOND, INDEMNIFICATION AND INSURANCE .....	18
8.01 PERFORMANCE BOND .....	18
8.02 INDEMNIFICATION .....	19
8.03 INSURANCE MAINTAINED BY AIRLINE .....	20
8.04 LIENS .....	21
8.05 LOSS OR DAMAGE TO PROPERTY .....	21
8.06 FORCE MAJEURE.....	22
8.07 INSURANCE MAINTAINED BY THE CITY .....	22
<b>PART IX.....</b>	<b>24</b>
QUIET ENJOYMENT; INCONVENIENCE DURING CONSTRUCTION .....	24
9.01 COVENANT OF QUIET ENJOYMENT .....	24
9.02 INCONVENIENCE DURING CONSTRUCTION .....	24
<b>PART X.....</b>	<b>24</b>
MISCELLANEOUS PROVISIONS .....	24
10.01 LEASE BINDING.....	24
10.02 PARAGRAPH HEADINGS AND INDEX.....	24
10.03 SIGNS .....	24
10.04 VENDING MACHINES .....	25
10.05 SALE OF FOOD, BEVERAGES AND MERCHANDISE.....	25
10.06 PURCHASES BY AIRLINE .....	25
10.07 NON-DISCRIMINATION.....	26
10.09 NOTICES .....	26
10.10 PLACE AND MANNER OF PAYMENTS .....	27
10.11 SEVERABILITY .....	27
10.12 SECURITY .....	27
10.13 WAIVERS.....	27
10.14 AIRLINE BOOKS AND RECORDS.....	28
10.16 CITY SMOKING POLICY.....	28
10.17 USE, POSSESSION OR SALE OF ALCOHOL OR DRUGS.....	28
10.18 THIRD PARTIES .....	28
10.19 SUPPLEMENTAL INFORMATION TO BE SUPPLIED BY AIRLINE .....	29
10.20 CITY NON-DISCRIMINATION.....	29
10.21 DISPUTES .....	29
10.22 AMENDMENTS TO EXHIBITS AND APPENDICES .....	29
10.23 ENTIRE AGREEMENT; AMENDMENT .....	30
10.24 CONDITION; FINAL APPROVAL.....	30

Exhibit A	Airfield Area
Exhibit B	[Reserved]
Exhibit C	- Preferential Use Passenger Aircraft Ramp and Apron Area
Exhibit D	-Demised Premises and Preferential Use Facilities
Exhibit E	-Summary of Airport Operation and Maintenance Responsibilities
Exhibit F	-Airline Rate-Making Methodology
Exhibit G	- Design Standards, Construction Procedures and Environmental Requirements
Appendix 1	-Standard Federal Assurances and Nondiscrimination
Appendix 2	-Disadvantaged Business Enterprises – Required Statements

## **AIRPORT USE AND LEASE AGREEMENT**

**THIS AIRPORT USE AND LEASE AGREEMENT** (the “Agreement”), made and entered into as of the date indicated on the City’s signature page, by and between the **CITY AND COUNTY OF DENVER**, a municipal corporation of the State of Colorado, (the “**CITY**”), Party of the First Part, and **American Airlines, Inc.**, a corporation organized and existing under and by virtue of the laws of the State of Delaware, and authorized to do business in the State of Colorado, hereinafter referred to as (the “**AIRLINE**”), Party of the Second Part;

### **W I T N E S S E T H :**

**WHEREAS**, the City owns and operates Denver International Airport (the “Airport”) and has the power to grant rights and privileges with respect thereto, as hereinafter provided; and

**WHEREAS**, the Airline is engaged in the business of transporting persons, property, cargo and mail, or one or more thereof, by aircraft; and

**WHEREAS**, the parties desire to enter into this Agreement for the use and lease of certain premises and facilities at the Airport as more fully hereinafter set forth;

**NOW THEREFORE**, for and in consideration of the mutual covenants and agreements herein contained, the City and the Airline do hereby mutually undertake, promise and agree, each for itself and its successors, as follows:

### **PART I DEFINITIONS**

#### **1.01 “AFFILIATED AIRLINE”**

Means (i) any wholly owned-subsiary Airline or majority-owned Airline, or (ii) any regional Airline operating under the name of the AIRLINE or under the name of AIRLINE’S wholly owned subsidiary, or (iii) any Airline flying under its own livery; and in any of the three abovementioned situations is (i) also not selling any seats in its own name and all seats are being sold in the name of the Signatory Airline that the Airline is under contract to and (ii) only if such Airline has been designated in writing by AIRLINE as an “Affiliated Airline” of AIRLINE.

#### **1.02 “AIRFIELD AREA FACILITIES”**

Means (A) runways; (B) taxiways; (C) passenger ramp and apron areas (other than the cargo ramp and apron areas); and (D) any extensions or additions to the above and any other space or facilities provided by the City at the Airport for public and common use by aircraft operators in connection with the landing and taking off of aircraft, or in connection with operations to be performed by aircraft operators upon the runways, taxiways, passenger ramp and apron areas; but only as from time to time provided by the City at the Airport for public and common use by aircraft operators.

### **1.03 “AIRPORT RULES AND REGULATIONS”**

Means the reasonable rules and regulations governing the use of the Demised Premises and any other portion of the Airport as may from time to time be adopted and promulgated by the City for the management, operation and control of the Airport, including those pertaining to the operation of automobile and vehicular traffic and parking facilities thereon, and with such reasonable amendments, revisions, additions and extensions thereof as may from time to time be adopted and promulgated; provided, however, such rules and regulations shall not be inconsistent with the rights herein granted to the Airline; provided, further, that nothing herein shall be considered to restrict the police power of the City.

### **1.04 “BAGGAGE SYSTEM”**

Means collectively all structures, improvement, equipment, belts, carts, walkways, impact protection, EDS modules, carousels, parts inventories, spare parts, tools, hardware and software, and other components of the baggage systems in the Terminal for processing, screening, and delivering checked baggage.

### **1.05 “DEMISED PREMISES”**

Means, at any time, those areas and facilities which are leased to a Signatory Airline for its use and occupancy, as defined in Section 3.01. Such areas and facilities may not be used or occupied by others unless authorized by such Signatory Airline and approved by the City.

### **1.06 “FISCAL YEAR”**

Means January 1 through December 31.

### **1.07 “GENERAL BOND ORDINANCE”**

Means the 1984 Airport System General Bond Ordinance approved by the City Council of the City and County of Denver on November 29, 1984, Ord. 626, Series of 1984, as supplemented or succeeded.

### **1.08 “MANAGER”**

Means the Manager of the City’s Department of Aviation or the Manager’s successor in function having jurisdiction over the management, operation and control of the Airport. “Manager’s authorized representative” or words of similar import shall mean the officer or employee of the City designated in writing by the Manager as the Manager’s authorized representative, until notice otherwise is thereafter given to the Airline.

### **1.09 “PREFERENTIAL USE FACILITIES”**

Means, at any time, those areas and facilities to which a Signatory Airline is granted the preferential use and occupancy as set forth in this Agreement.

## **1.10 “SIGNATORY AIRLINE”**

Means, at any time, Airline and each other airline which meet the definition and requirements specified in the Airport Rules and Regulations.

## **PART II AIRFIELD AREA FACILITIES**

### **2.01 AIRFIELD AREA FACILITIES TO BE PROVIDED**

The City agrees to provide, operate and maintain in good condition and repair at the Airport, in accordance with good airport maintenance practices, and to make available for use by aircraft operators, the Airfield Area Facilities shown upon the attached drawing of the Airport marked Exhibit A, which drawing is incorporated herein and made a part hereof by reference, and any additions or extensions thereto.

The City may from time to time make alterations to, or reconstruct, or relocate, or modify the design and type of construction of, or close the Airfield Area Facilities, or any portion or portions of them, either temporarily or permanently, provided that reasonably equivalent Airfield Area Facilities are made available to the Airline.

### **2.02 USE OF AIRFIELD AREA FACILITIES**

The airlines shall be entitled to use the Airfield Area Facilities for the following purposes:

- (A) Runways for the purpose of landing and taking off of aircraft.
- (B) Taxiways for the purpose of ground movement of aircraft.
- (C) Passenger ramp and apron areas, including, without limitation, the Airline’s preferential use areas shown on Exhibit C attached hereto (“Preferential Use Passenger Aircraft Ramp and Apron Areas”) for the purpose of unloading and loading passengers, baggage, freight, mail, supplies, and cargo to and from aircraft; for the purposes of performing such fueling and other ramp services as is more extensively defined in Section 2.03; for the purpose of parking mobile equipment while being actively used in connection with ramp operations, or for any other such purpose and, in connection with Airline’s Preferential Use Passenger Aircraft Ramp and Apron Areas, for coordinating and directing the parking and pushback of aircraft; but aircraft carrying property, cargo, and mail, but not passengers, shall use ramp areas designated for cargo operations by the Manager.
- (D) Training operations of the Airline.
- (E) Any other use normally incident to the foregoing.

The use of the Airfield Area Facilities shall be in common with others authorized by the City to do so, upon compliance with reasonable and nondiscriminatory terms and conditions

(including the payment of rates, fees, and charges) upon which they are made available for such use, and in accordance with Airport Rules and Regulations.

### **2.03 RAMP SERVICES**

Airline shall have the right to use the Airline's Preferential Use Passenger Aircraft Ramp and Apron Areas to provide services for aircraft occupying loading or unloading positions (herein called "ramp services") incidental to the immediate preparation of aircraft for scheduled operations, such services to include, among others, fueling, inspection, interior cleaning and non-routine maintenance (defined as minor repairs and the replacement or adjustment of equipment of an emergency nature, or in order to insure the safe departure of the aircraft), unless otherwise authorized by the Manager. Ramp services and facilities may be provided at loading and unloading positions in accordance with the Airport Rules and Regulations. The Airline shall leave the ramp area used by it for any such purposes in a neat, clean, safe and orderly condition upon completion of such services.

The Airline shall have the right to perform its own ramp services or to have such services performed by a regular ramp contractor (i.e., a person authorized by the Manager to perform ramp services at the Airport for any and all aircraft operations). If all such regular ramp contractors are unsatisfactory to the Airline from the standpoint of service or price, the Airline may notify the Manager that it desires to use the services of a contractor not authorized and the Manager may approve such contractor to perform such services; provided however, that the contractor shall accept a permit from the Manager upon the same terms and conditions as regular ramp contractors (except that at the option of the Manager, there may be omitted from such permit any provision requiring or permitting the contractor to serve others than the Airline). The Airline shall have the right to perform or receive ramp services, including refueling, for or from any other air carrier certificated to serve Denver, except that the location of ramp services outside the receiving airline's Preferential Use Facilities shall be determined by the Manager. No charges, fees or tolls of any nature shall be imposed by the City, directly or indirectly, against the Airline or such other air carrier for the right or privilege of providing or receiving such ramp services.

### **2.04 RATES, FEES AND CHARGES FOR THE USE OF THE AIRFIELD AREA FACILITIES**

The rates, fees and charges for the use of the Airfield Area Facilities shall be as established from time to time by the City in accordance with this Agreement. For each landing of an aircraft by the Airline at the Airport, Airline shall be assessed a landing fee in an amount equal to the number of thousands of pounds of maximum allowable gross landing weight of that aircraft, multiplied by the landing fee rate. The landing weight data will be compiled by the Airport through the use of an independent Radar based landing fee activity database. Airlines will access a secure website where a summary and detailed monthly activity report and applicable landing fee charges will be available by the 5<sup>th</sup> day of the month. The Airport will send an invoice by the 7<sup>th</sup> day of the month. The rates, fees and charges for the use of the Airfield Area shall be payable no later than twenty (20) days after the close of each calendar month of the term hereof.

The maximum allowable gross landing weight shall be determined based on the current FAA Type Certificate Data Sheet applicable to the particular type, design, and model of aircraft.

### **PART III**

## **LEASE AND USE OF DEMISED PREMISES AND PREFERENTIAL USE FACILITIES**

### **3.01 DEMISED PREMISES**

The City hereby leases to the Airline and the Airline hereby agrees to lease from the City space in the passenger terminal building and concourses at the Airport designated on Exhibit D (which drawings are incorporated herein and made a part hereof by reference) (collectively, the “Demised Premises”). The City and Airline acknowledge and agree that the dimensions of the Demised Premises as set forth in Exhibit D are defined as part of this Agreement. It is acknowledged and agreed that the Demised Premises under this Agreement constitute non-residential real property. Except to the extent required for the performance of the obligations of the Airline hereunder, nothing contained in this Agreement shall grant to the Airline any rights whatsoever in the air space above the Demised Premises except as approved by the City.

### **3.02 USE OF DEMISED PREMISES**

The Airline shall have the use of the portion of the Demised Premises designated in Exhibit D as “Demised Premises” during the term of the letting thereof, for the following purposes, purposes reasonably related thereto and for such other purposes as may be authorized in writing from time to time by the Manager:

(A) The handling of reservations, ticketing, billing and manifesting of passengers for air transportation;

(B) The clearance, checking-in, handling of outbound and inbound baggage and baggage claim, and the rendering of similar services to passengers for air transportation, and for the furnishing of information, including but not limited to, flight arrival, flight departure and baggage claim information to passengers and to the general public;

(C) Administrative offices, operations offices, employee lockers and restrooms, baggage, cargo and mail-handling and storage facilities and equipment; such uses and facilities to be located within Airline’s Demised Premises;

(D) Radio, data processing and other communication equipment;

(E) The assembling, handling and disbursing of baggage and lost and found articles;

(F) The operation, by Airline or an independent contractor, of passenger clubs and lounges where the Airline may serve food and beverage with or without charge; such uses and facilities to be located within Airline’s Demised Premises; and

(G) The installation, maintenance, and operation of facilities and equipment reasonably necessary or convenient to carry out any or all of the foregoing.



### **3.03 EFFICIENCY-IN-USE**

The Airline agrees to make every reasonable effort to offer to any other incoming or incumbent airline the opportunity to share use of its Demised Premises. In determining whether the use by another incoming or incumbent airline is reasonable and possible, the Airline will have the right to consider the compatibility of the proposed operation of the incoming or incumbent airline with those of the Airline, the operations of those with whom the Airline has subleases or handling agreements, the Airline's existing and immediate future flight schedules, the need for labor harmony, and the availability of other similar premises at the Airport. Should the Airline refuse another airline the opportunity to use the Airline's Demised Premises, the City and County of Denver, acting by and through its Manager, may review the Airline's Demised Premises usage, and should the Manager reasonably determine, considering all the factors noted herein and any other reasonable justification presented by Airline, including the Airline's reasons for such refusal, that the Airline unreasonably refused usage by such other airline, the Manager may immediately require the Airline to permit the incoming or incumbent airline to use that part of the Airline's Demised Premises and for those periods of time the City deems feasible, subject to the incoming or incumbent airline executing a mutually acceptable agreement with the Airline, and subject to the Manager's review and approval of said agreement.

### **3.04 PAYMENT OF FIXED AND VARIABLE RATES, FEES AND CHARGES**

(A) Rentals for the Demised Premises and Preferential Use Facilities shall be paid in twelve (12) equal monthly installments, and shall be due and payable, in advance, without notice on or before the first day of the then current month.

(B) In addition to the fixed rates, fees, and charges provided herein, Airline shall pay for other common use facilities, equipment, services and maintenance utilized by Airline. Said rates, fees and charges shall be paid monthly, in advance, and adjusted, if necessary, based on such actual costs. Any additional amount due from the Airline or refund owed to the Airline, as the case may be, based on such actual costs, shall be paid by the Airline or credited by the City, as the case may be, to rates, fees and charges. Such services may include, but are not limited to, industrial waste, sewer and water and trash.

### **3.05 USE OF PREFERENTIAL USE FACILITIES ON CONCOURSES**

The City hereby grants to the Airline preferential use of certain concourse facilities as designated in Exhibit C and Exhibit D where so indicated. The right of preferential use includes the right of the Airline and its Affiliated Airlines to enplane and deplane passengers and to schedule and use such facilities as defined herein, subject to the conditions set forth herein and in the Airport Rules and Regulations regarding the operation and use of concourses as such reasonable and nondiscriminatory rules and regulations exist or may be promulgated in the future. The right of preferential use is expressly understood to be a non-exclusive right, and the City retains the right to allow other airlines the use of the Airline's preferential use areas to the extent such other use does not infringe on the Airline's preferential use as herein defined.

Furthermore, it is expressly agreed and understood that the foregoing right of preferential use is not a property right and shall not be assigned, subleased or otherwise alienated or

hypothecated in any manner whatsoever by the Airline; except that, in the case of a merger of Airline with another airline or the acquisition of substantially all of Airline's assets by another airline, Airline's preferential use shall be transferable to the surviving airline.

The Airline's preferential use and scheduling rights on its passenger holdroom(s), associated passenger loading bridges, gate(s) and Preferential Use Passenger Aircraft Ramp and Apron Areas (collectively, the "Preferential Use Gates"), are subject to the following requirements ("Preferential Use Gate Usage Requirements"):

(A) For concourse-level Preferential Use Gates with passenger loading bridges designed for use by turbojet aircraft with more than 95 seats: four (4) departure equivalents (as set forth below) per day, per applicable gate, as averaged over any calendar quarter (i.e., the sum of all departure equivalents at all of Airline's gates for a calendar quarter, divided by the number of Airline's gates, divided by the number of total days in such calendar quarter). "Departure equivalents" shall mean and be counted as follows:

- (1) Aircraft with more than 300 seats count as three departures;
- (2) Aircraft with more than 200, but less than 301, seats count as two departures;
- (3) Aircraft with more than 150, but less than 201, seats count as one and one-quarter departures;
- (4) Aircraft with more than 95, but less than 151, seats count as one departure; and
- (5) Aircraft with 95 seats or less count as six-tenths of one departure.

(B) In the event Airline performs Ground Handling (as defined in Airport Rules and Regulations) for other parties, such activities count as departures for purposes of this gate usage requirement.

(C) If Airline fails to meet the minimum Preferential Use Gate Usage Requirements for a calendar quarter, without excuse, the Manager may notify Airline that it is in violation of this Agreement, and may return to the Airport's unassigned gate inventory, the number of Airline's concourse-level Preferential Use Gates failing to meet Airline's Preferential Gate Use Requirements. Airline shall have 10 business days from receipt of such notice to specify which Preferential Use Gates are to be returned; provided, however, that the Manager may select different Preferential Use Gates as may be necessary to create contiguity with other unleased gates.

(D) Upon Airline's request, the Manager in its sole discretion may waive preferential status with corresponding rent reductions to airline-leased space. As long as the space remains in Airline's leasehold, the Airline may provide the City with 90 days written notice and reclaim such space for Airline's own use, to sublet to another party for their use, or to perform Ground Handling services for another party on that gate.

(E) Airline agrees to abide by reasonable and nondiscriminatory rules and regulations regarding the operation and use of concourses as such rules and regulations exist or may be promulgated in the future in the Airport Rules and Regulations. The City will provide not less than 21 days' notice to Airline when any rule or regulation affecting Airline is proposed for amendment, and will post amendments when final.

### **3.06 USE OF AND ACCESS TO BAGGAGE SYSTEM**

The City hereby grants to the Airline a license to use the Baggage System on a common use basis, for the purpose of loading and unloading baggage to and from aircraft, and access to the Baggage System for activities reasonably necessary or convenient in connection with the foregoing. The grant of such license and the use of and access to the Baggage System is more specifically set forth in a Baggage System License Agreement between City and Airline. The Airline acknowledges and agrees that the Baggage System shall be managed, operated, and maintained for the benefit of the air carriers by an operator selected by the City and the Signatory Airlines. The Airline's use of and access to the Baggage System shall be conducted so as not to interfere with the safe and efficient operation of the Baggage System by the operator.

The parties agree that certain baggage belt areas behind ticket counters in the Terminal Building which are part of the Airline's Demised Premises shall be considered exclusively leased to the Airline for the purpose of passenger operations, but nonetheless those baggage belts are part of the Baggage System for the purpose of operation and maintenance, in accordance with the terms and conditions of the City's agreement with the operator.

### **3.07 USE OF PUBLIC AREAS**

Airline and its employees, agents, passengers and invitees, its suppliers of materials and furnishers of services shall have the non-exclusive right to use, in common with all others, all public areas of the Airport, together with all improvements, facilities and equipment located therein, including, without limitation, the following: passenger transit systems, passenger walkways, public lobbies, public waiting rooms, public stairways, elevators and escalators, public restrooms, public roads and parking lots. Nothing herein shall be deemed to convey to Airline any interest or property rights in such public areas, or to any improvements thereto.

**PART IV**  
**PROVISIONS RELATING TO AIRFIELD AREA FACILITIES, PREFERENTIAL USE FACILITIES, DEMISED PREMISES, AND JOINT USE FACILITIES**

**4.01 MAINTENANCE**

(A) The City shall provide services and maintenance in the Airfield Area Facilities, Preferential Use Facilities, Demised Premises and Joint Use Facilities as indicated in Exhibit E, attached hereto and made a part hereof, and shall bear the cost thereof in consideration of payment to be made by the Airline pursuant to the provisions hereof.

(B) The Airline agrees that it will at all times under its control maintain its Preferential Use Facilities, Demised Premises and Joint Use Facilities in a neat, clean, safe and orderly condition, in compliance with the requirements of 42 U.S.C. § 12101 et seq., 49 U.S.C. § 41705, and 14 C.F.R. Part 382, and in keeping with the general decor of the area in which they are situated, and that it will perform those maintenance services shown on said Exhibit E to be performed by the Airline.

**4.02 AIRLINE ALTERATIONS TO DEMISED PREMISES**

The Airline may, with prior written approval of the Manager, at its own cost and expense, install in the Demised Premises any fixture or improvement or do or make alterations or do remodeling, germane to the use herein or hereafter granted. Any fixtures, improvements, equipment and other property installed, erected or placed by the Airline in, on or about such Demised Premises shall be deemed to be personal and shall be and remain the property of the Airline, except as otherwise provided herein and the Airline shall have the right at any time during the term hereof to remove any or all of its property, subject to the Airline's obligation to repair damage, if any, resulting from such removal. All such fixtures, improvements, equipment and other property shall be removed from the said Demised Premises by the expiration or earlier termination of letting and the Demised Premises restored to the condition existing at the time of the letting, reasonable wear and tear excepted, unless the City, acting by and through its Manager, shall have advised the Airline in writing at the time of such installation or not less than sixty (60) days in advance of such expiration or not less than thirty (30) days in advance of such earlier termination, of its willingness to accept title to such fixtures, improvements, equipment and other property in lieu of restoration of the Demised Premises. It is understood and agreed that during such period and until such personal property is removed, the Airline shall pay to the City the full rental applicable to those Demised Premises, as determined by the Manager, which are directly associated with said personal property and which Demised Premises are not usable by others until said personal property is removed.

Said improvements, and all alterations thereof and additions thereto, shall in all respects be constructed in accordance with the ordinances and any applicable code or rule and regulation of the City and County of Denver, including the Airport Rules and Regulations governing tenant construction specifications and other non-technical requirements, in accordance with the attached Exhibit G, "Design Standards, Construction Procedures and Environmental Requirements," which is incorporated herein by reference, in accordance with the requirements of 42 U.S.C. §

12101 et seq., 49 U.S.C. § 41705, and 14 C.F.R. Part 382, and pursuant to any required building permit to be obtained from the City and according to the customary terms and conditions thereof.

#### **4.03 SUB-LETTING, ASSIGNMENT AND GROUND HANDLING ARRANGEMENTS**

No interest or rights under this Agreement may be transferred except as provided under this Section 4.03

Airline may sublet, assign or otherwise transfer the Demised Premises, in whole or in part to another airline, or use the Demised Premises for the handling by Airline's personnel of air transportation operations of other airlines, subject, however, to each of the following conditions:

(A) No sub-lease, assignment, ground handling agreement or other transfer shall relieve Airline from primary liability for any of its obligations hereunder, and Airline shall continue to remain primarily liable for the payment of rentals, fees and charges applicable to such premises and facilities hereunder;

(B) Airline shall provide written notice to the City and a copy of the proposed sublease, assignment, ground handling agreement or other transfer not less than thirty (30) days prior to the effective date of such arrangement;

(C) Any sublease, assignment, ground handling agreement or other transfer shall be subject to the prior written approval of the Manager; and

(D) Unless a gate sharing agreement is in place as authorized by the Manager under Airport Rules and Regulations, any authorization by Airline for use of a Preferential Use Gate by another airline shall require such other airline to remit directly to the City a non-preferential use gate fee as established by the Airport Rules and Regulations. All such fees shall be credited in the calculation of rentals, rates, fees and charges.

#### **4.04 RIGHT TO ENTER AND MAKE REPAIRS**

The City and its authorized officers, employees, agents, contractors, subcontractors and other representatives shall have the right (at such times as may be reasonable under the circumstances and with as little interruption to the Airline's operations as is reasonably practicable) to enter upon the Demised Premises for the following purposes:

(A) To inspect the Demised Premises at reasonable intervals during regular business hours (or at any time in case of emergency) to determine whether the Airline has complied and is complying with the terms and conditions of this Agreement with respect to the Demised Premises.

(B) To perform maintenance and make repairs and replacements in any case where the Airline is obligated to do so and has failed after reasonable notice to do so, in which event the Airline shall promptly upon demand reimburse the City for the actual cost thereof, plus a 15% administrative charge.

(C) To perform maintenance and make repairs and replacements in any case where the City is obligated to do so, and in any other case where the City, in its reasonable judgment, determines that it is necessary or desirable to do so in order to preserve the structural safety of the Demised Premises or the building in which they are located or to correct any condition likely to cause injuries or damages to persons or property.

(D) In the exercise of the City's police power.

No such entry by or on behalf of the City upon such Demised Premises leased to Airline shall cause or constitute a termination of the letting thereof or be deemed to constitute an interference with the possession thereof by the Airline.

#### **4.05 ABANDONMENT OF DEMISED PREMISES**

If the Airline ceases to occupy and use a material portion of the Demised Premises for a continuous period of six (6) consecutive months or longer, the City, acting by and through the Manager, may consider such portion of the Demised Premises abandoned, and if needed for another use, upon not less than thirty (30) days' written notice to the Airline, terminate the lease for such portion of the Demised Premises.

#### **4.06 DESTRUCTION OF PREMISES**

If by reason of any cause Airline's Demised Premises, or any portion thereof, are damaged or destroyed by fire or other casualty, then:

(A) The City, after consultation with Airline, shall forthwith repair, reconstruct and restore the damaged or destroyed portions of the Demised Premises to substantially the same condition, character, utility and value as existed prior to such damage or destruction, unless the City and Airline agree that no such reconstruction is necessary, or that reconstruction to some other condition, character, utility and value is appropriate or desired; and

(B) If such Demised Premises are damaged to such an extent that the Demised Premises are untenable, the City, acting by and through the Manager, will make all reasonable efforts to provide substantially equivalent substitute premises and facilities, and such substitute premises and facilities will be made available to Airline consistent with those rentals, fees and charges for the use of the Airport established and modified from time to time by the City in accordance with this Agreement.

(C) For portions of the Demised Premises that are untenable, Airline shall receive a pro rata abatement of rentals, fees and charges applicable thereof from the date of such occurrence to the date upon which such portions of the Demised Premises are repaired and restored.

#### **4.07 COMMON USE SYSTEMS**

Prior to implementation of multiple or common use systems, the City will consult with Airline. Thereafter, upon nine (9) months advance written notice by the City, the Airline agrees that it will make all necessary modifications and improvements to become compatible with the

City's multiple or common use system installations. After the City installs common use systems, all future improvements and any new equipment of the Airline shall be compatible with the City's multiple or common use system installations. The Airline shall not install any proprietary terminal equipment without the prior written approval of the Manager.

#### **4.08 REASSIGNMENT OF DEMISED PREMISES AND PREFERENTIAL USE FACILITIES**

After consultation with all affected airlines, in order to maximize the highest and best use of the City's airline facilities, the City may at its sole discretion, relocate and reassign the Airline's use and lease of the Demised Premises and Preferential Use Facilities upon sixty (60) days advance written notice. The City will be responsible for reasonable costs related to any such relocations and/or reassignments.

### **PART V GENERAL PROVISIONS**

#### **5.01 AGREEMENTS WITH THE UNITED STATES**

This agreement is subject and subordinate to the provisions of any agreements between the City and the United States relative to the operation or maintenance of the Airport, the execution of which has been or may be required as a condition precedent to the transfer of federal rights or property to the City for airport purposes, or to the expenditure of federal funds for the extension, expansion or development of the Airport, including the expenditure of federal funds for the development of the Airport in accordance with the provisions of the Airport and Airway Improvement Act of 1982, as amended. The provisions in the attached Appendices 1 and 2 are hereby incorporated herein by reference.

#### **5.02 BOND ORDINANCES**

This Agreement is in all respects subject and subordinate to any and all City bond ordinances applicable to the Airport and airport system and to any other bond ordinances which should amend, supplement or replace such bond ordinances.

The parties to this Agreement acknowledge and agree that all property subject to this Agreement which was financed by the net proceeds of tax-exempt bonds is owned by the City, and Airline agrees not to take any action that would impair, or omit to take any action required to confirm, the treatment of such property as owned by the City for purposes of Section 142(b) of the Internal Revenue Code of 1986, as amended. In particular, the Airline agrees to make, and hereby makes, an irrevocable election (binding on itself and all successors in interest under this Agreement) not to claim depreciation or an investment credit with respect to any property subject to this Agreement which was financed by the net proceeds of tax-exempt bonds and shall execute such forms and take such other action as the City may request in order to implement such election.

#### **5.03 LAWS, REGULATIONS, AND AGREEMENTS TO BE OBSERVED**

(A) The Airline shall not use, or authorize the use by any other person or party, of all or any portion of the Demised Premises, or any part of the Airport to which it is granted a right of use or occupancy by this Agreement, for any purpose or use other than those authorized by this Agreement, or hereafter authorized in writing by the Manager. No use shall be considered authorized by this Agreement if such use would adversely affect the tax-exempt status of Airport Revenue Bonds.

(B) The Airline shall comply with and shall cause its officers and employees and any other persons over whom it has control to comply with the Airport Rules and Regulations.

(C) The Airline shall, at all times, faithfully obey and comply with all existing laws, rules and regulations adopted by federal, state, local or other governmental bodies and applicable to or affecting the Airline and its operations and activities in and at the Airport, including 49 U.S.C. § 41705 (the Air Carrier Access Act) and implementing regulations at 14 C.F.R., Part 382, and 42 U.S.C. § 12101 et seq. (the Americans with Disabilities Act) and implementing regulations.

(D) It is agreed that any disputes regarding laws, ordinances, rules and regulations regarding the Airport issued by the City shall first be presented to administrative hearing before the Manager or the Manager's authorized representative following the procedure outlined in Denver Revised Municipal Code Section 5-17. It is further agreed that no action shall be brought against the City contesting any such laws, ordinances, rules and regulations until there has been full compliance with the terms of said section 5-17. Nothing herein shall be construed to prevent Airline from contesting in good faith any laws, ordinances, rules or regulations without being considered in breach hereof during such time as is required to exhaust the administrative hearing procedures, so long as such contest is diligently commenced and prosecuted by Airline.

## **PART VI RATE-MAKING PROCEDURES AND REESTABLISHMENT**

### **6.01 GENERAL PROVISIONS**

The City agrees that it will establish and fix airline rentals, rates, fees and charges in accordance with the cost- accounting concepts and rate-making procedures described in attached Exhibit F. Further, the City agrees that said rentals, rates, fees and charges shall be reasonable in relation to the cost of providing, operating and maintaining the services or facilities used or leased by the Airline. The City acknowledges its obligations to charge air carriers nondiscriminatory and substantially comparable rates, fees, rentals and other charges, subject to reasonable classification such as tenant and non-tenant, Signatory and non-Signatory (as such is defined herein). The City agrees that it will not enter into an Airport Use and Facilities Lease Agreement with another air carrier which is substantially more favorable, unless the same rights, terms, and privileges are offered to the Airline.

Airline acknowledges that the rate base for rentals, fees and charges must generate gross revenues, which together with Other Available Funds (as defined in the General Bond



Ordinance) must be sufficient to satisfy the Rate Maintenance Covenant of the General Bond Ordinance, and Airline agrees to pay such rentals, rates, fees and charges.

The City, acting by and through its Manager, may from time to time reestablish the rentals, rates, fees and other charges for the use of Airport in accordance with the concepts and rate-making procedures provided for herein.

The City, acting by and through its Manager, may from time to time, amend the rate-making concepts and procedures set forth in this Agreement with the written consent of a majority of the Signatory Airlines not in default of the Agreement, represented by: (1) a numerical majority; and (2) a majority in terms of rentals, rates, fees and charges paid in the preceding fiscal year.

## **6.02 NON-AIRLINE REVENUE**

In order to minimize the rentals, rates, fees and charges which Airline is obligated to pay under this Agreement, the City shall promote and develop non-airline revenues at the Airport in a manner consistent with that of a reasonably prudent airport operator.

## **6.03 PROJECTION OF RENTALS, RATES, FEES AND CHARGES**

Not later than forty five (45) days prior to the end of each Fiscal Year during the term of this Agreement, City shall furnish Airline with a projection of the rentals, rates, fees and charges for the next ensuing year for each cost center of Airport. Such projection will include the Airport proposed expense budget, and projection of aircraft operations, passenger enplanements, and debt service payments for the ensuing year. The City shall convene a meeting with the Signatory Airlines operating at the Airport not later than thirty (30) days prior to the end of each Fiscal Year to consult and review with the Signatory Airlines the projection of rentals, fees and charges for the next ensuing year.

## **6.04 MID-YEAR REVIEW OF RENTALS, RATES, FEES AND CHARGES**

Not later than September 1<sup>st</sup> of each year, the City shall furnish the Airline with a projection of rentals, rates, fees and charges (the Mid-Year Projection), which shall reflect the most recently available information on current aircraft operations and passengers enplaned as well as expenses actually incurred and revenues realized thus far during such fiscal year. The City shall provide a pro forma projection of revenues and expenses for the current fiscal year. The City shall convene a meeting with the Signatory Airlines operating at the Airport to consult and review the Mid-Year Projection and any adjustment to the monthly rentals, rates, fees and charges for such fiscal year.

## **6.05 FINAL AUDIT**

Upon release by the City's independent auditors of the audited financial statements of Airport, the City shall furnish Airline with a copy of the annual audit report, prepared in accordance with Generally Accepted Accounting Principles and certified by an independent accountant, covering the operation of the Airport for such preceding fiscal year. As soon as practical following the release of the annual audit report, the City will prepare an analysis of additional charges or credit due (Year-End Settlement) along with the Airline Revenue Credit calculation to Airline for the preceding audited fiscal year. If the rentals, fees and charges paid by Airline were greater than the respective amounts chargeable to Airline, Airline shall receive credits promptly in the amount of such overpayment against future rentals, fees and charges. If the rentals, fees and charges paid by Airline were less than the respective amounts chargeable to Airline, Airline shall pay promptly the amount of any such deficiency.

## **6.06 PASSENGER FACILITY CHARGES**

(A) "Passenger Facility Charges" or "PFCs" are charges collected by the Airline pursuant to the authority granted by the Aviation Safety and Capacity Expansion Act of 1990, 49 U.S.C. Section 40117, and 14 CFR Part 158, as amended. Airline acknowledges that PFCs are funds held for the benefit of the City. Airline further acknowledges that PFCs are not property of the Airline under any of the circumstances described in paragraph 7.02(D) herein. Airline agrees that under the circumstances described in paragraph 7.02(D) herein, Airline will immediately establish a fund and segregate PFC funds collected as required by 49 U.S.C. Section 40117(m)(1).

(B) Airline shall abide by the remittance, reporting and recordkeeping requirements of PFCs as outlined in 14 CFR Part 158 and referenced in Airport Rules and Regulations, and the Airport shall abide by the public agency requirements outlined in 14 CFR Part 158.

## **PART VII TERM OF THE AGREEMENT**

### **7.01 TERM OF AGREEMENT**

The term of this Agreement shall commence on January 1, 2012 and shall terminate on December 31, 2016, unless this Agreement is earlier cancelled, terminated, or extended as hereinafter provided.

### **7.02 TERMINATION OF LEASE BY CITY**

The City, acting by and through its Manager, may declare this Agreement terminated in part or in its entirety, as the Manager deems appropriate, upon the happening of any one or more of the following events and may exercise all rights of entry and reentry with or without process of law, without liability for trespass upon the Preferential Use Facilities and Demised Premises:

(A) If the rentals, rates, fees, charges or other money payment which the Airline herein agrees to pay, or any part thereof, shall be unpaid after the date the same shall become due; or

(B) If the Airline shall use or permit the use of the Preferential Use Facilities and Demised Premises covered hereby at any time for any purpose for which the use thereof at that time is not authorized by this Agreement or by the subsequent written consent of the Manager, or shall use or permit the use thereof in violation of any law, rule or regulation to which the Airline has agreed in this Agreement to conform; or

(C) If Airline shall be in violation of any provision of Section 4.03 with respect to the subletting of the Demised Premises hereunder; or

(D) If, during the term of this Agreement, the Airline shall (a) apply for or consent to, in writing signed on behalf of the Airline by any of its officers or its duly authorized attorney, the appointment of a receiver, trustee or liquidator of the Airline or of all or a substantial part of its assets, (b) file a voluntary petition in bankruptcy, or admit in writing its inability to pay its debts as they come due, (c) make a general transfer for the benefit of creditors, (d) file a petition or an answer seeking reorganization or arrangement with creditors or to take advantage of an insolvency law, or (e) file an answer admitting the material allegations of a petition filed against the Airline in any bankruptcy, reorganization or insolvency proceeding, or if during the term of this Agreement an order, judgment or decree shall be entered by any court of competent jurisdiction, on the application of a creditor, adjudicating the Airline as bankrupt or as insolvent, or approving a petition seeking a reorganization of Airline or of all or a substantial part of its assets, and such order, judgment, or decree shall continue unstayed and in effect for any period of ninety (90) consecutive days, then, and in any of such events, the City may give to the Airline a notice of intention to end the term of this Agreement in its entirety after the expiration of thirty (30) days from the date of service of such notice, and on the date set forth in said notice the term of this Agreement and all right, title and interest of Airline hereunder shall expire as fully and completely as if that day were the date herein specifically fixed for the expiration of the term, and the Airline will then voluntarily and peaceably quit and surrender the Preferential Use Facilities and Demised Premises covered hereby to the City, but the Airline shall remain liable as herein provided; or

(E) If Airline fails to make its Preferential Use Facilities and Demised Premises available for use in accordance with 56 Fed. Reg. 24, 254-01 (1991) (codified at 14 C.F.R. 158, App. A, B.7), but any right to terminate by the City under this section 7.02 (E) may be exercised only with respect to the portion of the Exclusive Use Premises required by 56 Fed. Reg. 24, 254-01 (1991) (codified at 14 C.F.R. 158, App. A, B.7).

(F) If any of Airline's directors or officers assigned to or responsible for operations at the Airport shall be or have been convicted of any crime which is a disqualifying offense under 49 CFR 1544 governing issuance of airport security badges.

### **7.03 TERMINATION OF LEASE BY AIRLINE**

The Airline, at its option, may declare this Agreement terminated in part or in its entirety upon the happening of any one or more of the following events:

(A) If by any reason of any action or non-action of any federal or other governmental agency having jurisdiction to grant a certificate of convenience and necessity, or similar document, authorizing the Airline to operate aircraft in or out of the Airport (including action in the nature of alteration, amendment, modification, suspension, cancellation or revocation of any such certificate, permit or document), the Airline shall cease to have authority to operate aircraft in and out of the Airport pursuant to such a certificate or document, provided that (1) such governmental action or non-action was not requested by the Airline, and the Airline made all reasonable efforts to prevent such governmental action or non-action, or in the alternate, (2) the City had a reasonable opportunity to appear before such federal or governmental agency and be heard in opposition to such governmental action or non-action prior to the occurrence, if it desired to do so or, in the alternate, (3) the Airline gave the City reasonable advance notice that such governmental action or non-action was being requested or might occur, and the Airline made a reasonable effort to the end that the City might have an opportunity to appear and be heard as aforesaid; or

(B) If by legislative action of the United States the Airline is deprived of such certificate of similar document; or

(C) If a court of competent jurisdiction issues an injunction or restraining order against the City or any successor body to the City preventing or restraining the Airport for airport purposes in its entirety, or the use of any part thereof which may be used by the Airline and which is substantially necessary to the Airline for its operations, and if such injunction remains in force for a period of ninety (90) days or more and is not stayed by appeal or a writ of error; or

(D) If the City's operation of Airport is substantially restricted by action of any federal or other governmental agency having jurisdiction with respect thereto, or the occurrence of any fire or other casualty substantially and adversely affects, for a period of at least ninety (90) days, Airline's use of Airport in the conduct of its air transportation business; provided, however, none of the foregoing is due primarily to any fault of Airline.

### **7.04 EFFECTIVE DATE OF TERMINATION**

Notwithstanding anything to the contrary in this Agreement, no termination declared by either party shall be effective until not less than thirty (30) days have elapsed after written notice to the other specifying the date upon which such termination shall take effect and the cause for which it is being terminated (and if such termination is by reason of a default under this Agreement for which termination is authorized, specifying such default with reasonable certainty). No such termination shall be effective if such cause shall have been cured or obviated during such thirty (30) day period, or in the event such cause is a default under this Agreement (for which termination is authorized) and if by its nature such default cannot be cured within such thirty (30) day period, such termination shall not be effective if the party in default commences to correct such default within said thirty (30) days and corrects the same as promptly

as reasonably practicable; provided that the thirty (30) day period shall not apply to termination declared for failure of Airline to make money payments hereunder, for which termination may be declared by the City upon fifteen (15) days' written notice, unless Airline remedies such default within such fifteen (15) day period; and provided further that the Airline will be allowed only two (2) notices of default with respect to money payments in any one year which it may cure. Upon termination of this Agreement, the parties hereto shall be relieved from all obligations hereunder except as set forth in Sections 6.05, 7.05, 7.06, 8.02, 10.08, 10.14, and 10.15. The right of any party hereto to terminate this Agreement shall not in any manner affect or limit such party's right to exercise any other right or remedy it may have rather than its right of termination.

## **7.05 SURRENDER AND HOLDING OVER**

The Airline covenants that at the expiration of the period for which the Demised Premises are leased to it, or at the earlier termination of the letting thereof, it will quit and surrender such Demised Premises in good state and condition, reasonable wear and tear, acts of God or other casualty and damage due to the negligent or willful act or omission of the City excepted, and except as otherwise provided in Section 4.02, the Airline shall forthwith remove there from all equipment, trade fixtures and personal property belonging to it. The City shall have the right on such termination to enter upon and take possession of such Demised Premises with or without process of law, without liability for trespass.

Holding over by Airline following the expiration of the term of this Agreement or any extension thereof, without an express agreement as to such holding over, shall be deemed and taken to be a periodic tenancy from month-to-month. The Airline shall be subject to all the terms and conditions of this Agreement as amended from time to time or any extension thereof. Rent, fees and charges for each month of such holding over shall be paid as provided herein and in a sum equal to the monthly rental required for the month prior to the end of the term of this Agreement or as reestablished as provided for herein. In the event Airline fails to surrender the Preferential Use Facilities and Demised Premises upon termination or expiration of this Agreement, or such month-to-month tenancy, then Airline shall indemnify City against loss or liability resulting from any delay of Airline in not surrendering same.

## **7.06 TERMINATION OF HOLDOVER**

If Airline holds over pursuant to Section 7.05 hereof, either party may, with or without cause, cancel or terminate said tenancy by giving not less than thirty (30) days written notice to the other party. Said notice shall set out the date of such cancellation and termination.

# **PART VIII PERFORMANCE BOND, INDEMNIFICATION AND INSURANCE**

## **8.01 PERFORMANCE BOND**

Unless otherwise provided by Airport Rules and Regulations, as they may be adopted or amended from time to time, upon the commencement of the term of this Agreement, the Airline shall deliver to the Manager for the City and County of Denver, and shall maintain in effect at all times during the term of this Agreement, including a period of six (6) months after expiration (or earlier termination of the letting of the Demised Premises hereunder) of said Agreement, a valid

corporate Performance Bond, or an irrevocable Letter of Credit, in the amount of Three Million Dollars (\$3,000,000.00), or an amount equal to three (3) months of rent, rates, fees or charges payable hereunder, whichever is less, payable without condition to the City and County of Denver, with surety acceptable to and approved by the City's Manager, which bond or irrevocable letter of credit shall guarantee to the City full and faithful performance of all of the terms and provisions of this Agreement to be performed by the Airline, and as said Agreement may be amended, supplemented or extended.

Notwithstanding the foregoing, if at any time during the term hereof, the Manager deems the amount of the surety insufficient to properly protect the City from loss hereunder because the Airline is or has been in arrears with respect to such obligations or because the Airline has, in the opinion of the Manager, violated other terms of this Agreement, the Airline agrees that it will, after receipt of notice, increase the surety to an amount required by the Manager; provided however, the percentage increase in the amount of surety shall not exceed the annual percentage increase that has occurred with respect to the Airline's rental and fee rates in effect under this Agreement.

## **8.02 INDEMNIFICATION**

The Airline agrees to indemnify and save harmless the City, its officers, and employees, from and against (A) any and all loss of or damage to property, or injuries to, or death of, any person or persons, including property and officers, employees and agents of the City; and (B) all claims, damages, suits, costs, expense, penalties, liability, actions or proceedings of any kind or nature whatsoever, of or by anyone whomsoever; which, with respect to clauses (A) and (B) hereof, in any way result from, or arise out of, Airline's operations in connection herewith, or its use or occupancy of any portion of the Airport and the acts, omissions, or wrongful conduct of officers, employees, agents, contractors or subcontractors of the Airline including without limitation, the provision or failure to provide security as herein required and the use, disposal, generation, transportation or release of pollutants, including but not limited to oil, glycol, toxic or hazardous materials at Denver International Airport by the Airline, its contractors, employees, agents, customers, or anyone claiming or acting by or through the Airline.

Airline further agrees that if a prohibited incursion into the Air Operations Area occurs, or the safety or security of the Air Operations Area, the Airfield, the Baggage System or other sterile area safety or security area is breached by or due to the negligence or willful act or omission of any of Airline's employees, agents, or contractors and such incursion or breach results in a civil penalty action being brought against the City by the U.S. Government, Airline agrees to reimburse the City for all expenses, including attorney fees, incurred by the City in defending against the civil penalty action and for any civil penalty or settlement amount paid by the City as a result of such incursion or breach of airfield or sterile area security. The City shall notify Airline of any allegation, investigation, or proposed or actual civil penalty sought by the U.S. Government for such incursion or breach. Civil penalties and settlement and associated expenses reimbursable under this Paragraph include but are not limited to those paid or incurred as a result of violation of Federal Aviation Administration (FAA) regulations or Transportation Security Administration (TSA) regulations, as they may be amended, or any similar law or regulations intended to replace or compliment such regulations.

Without limitation, the terms of this indemnity include an agreement by Airline to indemnify, defend and hold harmless the City from and against any and all expense, loss, claim, damage, or liability suffered by City by reason of Airline's breach of any environmental requirement existing under federal, state or local law, regulation, order or other legal requirement in connection with any of Airline's acts, omissions, operations or uses of property relating to this Agreement, or such a breach by the act or omission of any of Airline's officers, employees, agents, or invitees, whether direct or indirect, or foreseen or unforeseen, including (but not limited to) all cleanup and remedial costs actually and reasonably incurred to satisfy any applicable remediation obligation required by federal, state or local law, and reasonable legal fees and costs incurred by City in connection with enforcement of this provision, but excluding damages solely relating to diminution in value of City real property.

Provided however, the City agrees that (I) the Airline need not save harmless or indemnify the City against damage to or loss of property, or injury to or death of persons, caused by the negligence or willful acts of the City, its officers, employees, contractors and agents, and (II) the City will give prompt written notice to the Airline of any claim or suit and the Airline shall have the right to assume the defense and compromise or settle the same to the extent of its own interest. Provided, however, the indemnity provided for herein shall apply only to the extent the City is not reimbursed out of insurance proceeds.

### **8.03 INSURANCE MAINTAINED BY AIRLINE**

At all time during the term of this Agreement, unless otherwise required by federal or state governmental law or regulation, the Airline is required and agrees, at its own cost and expense, to provide and keep in force for the benefit of the Airline and the City, a policy, or policies, of insurance written on a single limit each occurrence basis with limits of not less than Three Hundred Million Dollars (\$300,000,000.00) for bodily injury and property damage arising from any operation of the Airline at the Airport and contractual liability coverage. The Manager may increase the limit of insurance required when, in her discretion, she deems the amount stated herein is insufficient. The Manager may establish lesser amounts of insurance for airlines operating exclusively with aircraft of thirty (30) seats or less.

Such insurance policy, or policies, and certificates of insurance evidencing the existence thereof shall cover all operations of the Airline at the Airport, shall be in a form and written by a company, or companies, approved by the Airport's Risk Manager and shall insure the Airline's agreement to indemnify the City as set forth in the indemnification provisions hereof. The amount of insurance required hereunder shall in no way limit the liability of the Airline as provided in Section 8.02 of this Agreement. The City shall not be named insured of said insurance. Each such policy and certificate shall contain a special endorsement stating "This policy will not be materially changed or altered or canceled without first giving thirty (30) days written notice by certified mail, return receipt requested, to the Manager of Aviation, Denver International Airport, AOB- 9<sup>th</sup> Floor, 8500 Peña Boulevard, Denver, Colorado 80249-6340." All such policies of insurance, or certified copies thereof, together with receipts showing payment of premiums thereon, shall be made available for review by the City at such times and places as required by the Manager. Certificates of insurance evidencing the existence of said policies shall be delivered to and left in the possession of said Manager.

## **8.04 LIENS**

Except to the extent inconsistent with other provisions of this Agreement, the Airline covenants and agrees to pay promptly all lawful taxes, excises, license fees and permit fees applicable to its operations at the Airport and to take out and keep current all licenses, municipal, state or federal, required for the conduct of its business at and upon said Airport, and further agrees not to permit any of said taxes, excises or license fees to become delinquent. The Airline further covenants and agrees at all times to maintain adequate Worker's Compensation Insurance in accordance with any present or future Colorado law with an authorized insurance company, or through the Colorado State Compensation Insurance Fund, or through an authorized self-insurance plan approved by the State of Colorado insuring the payment of compensation to all its employees at the Airport. The Airline also covenants and agrees not to permit any mechanic's or materialman's or any other lien to be foreclosed upon the Airport and improvements thereto or thereon, or any part or parcel thereof, by reason of any work or labor performed or materials furnished at the request of the Airline by any mechanic or materialman. The Airline further covenants and agrees to pay promptly when due all bills, debts and obligations incurred by it in connection with its operation of said business on the Airport, and not to permit the same to become delinquent and to suffer no lien, mortgage, judgment or execution to be filed against said premises or improvements thereon which will in any way impair the rights of the City under this Agreement. The Airline shall have the right on giving the City prior written notice to contest any such mechanic's, materialman's or any other lien, and the Airline shall not, pending the termination of such contest, be obligated to pay, remove or otherwise discharge such lien or claim. The Airline agrees to indemnify and save harmless the City from any loss as a result of the Airline's action as aforesaid.

If the Airline shall in good faith proceed to contest any such tax, assessment or other public charge, or the validity thereof, by proper legal proceedings which shall operate to prevent the collection thereof or to prevent the appointment of a receiver because of nonpayment of any such taxes, assessments or other public charges, the Airline shall not be required to pay, discharge or remove any such tax, assessment or other public charge so long as such proceeding is pending and undisposed of; provided, however, that the Airline, not less than five (5) days before any such tax, assessment or charge shall become delinquent, shall give notice to the City of the Airline's intention to contest its validity. If such notice is so given by the Airline to the City and such contest is conducted in good faith by the Airline, the City shall not, pending the termination of such legal proceedings, pay, remove or discharge such tax, assessment or other charge.

## **8.05 LOSS OR DAMAGE TO PROPERTY**

The City shall not be liable for any loss of property by theft or burglary from the airport or for any damage to person or property on said Airport resulting from airport operations including but not limited to operating the elevators or electric lighting, or wind, water, rain or snow, which may come into or issue or flow from any part of said Airport, or from the pipes, plumbing, wiring, gas or sprinklers thereof or that may be caused by the City's employees or any other cause whatsoever, and the Airline hereby covenants and agrees to make no claim for any such loss or damage at any time.



## **8.06 FORCE MAJEURE**

Neither the City nor the Airline shall be deemed to be in breach of this Agreement by reason of failure to perform any of its obligations under this Agreement if, while and to the extent that such failure is due to embargoes, shortages of materials, acts of God, acts of the public enemy, acts of superior governmental authority, sabotage, strikes, boycotts, labor disputes, weather conditions, riots, rebellion and any circumstances for which it is not responsible and which are not within its reasonable control. This provision shall not apply to failures by the Airline to pay rents, fees or other charges, or to make any other money payment whatsoever required by this Agreement, except in those cases where provision is made in this Agreement for the abatement of such rents, fees, charges or payments under such circumstances.

## **8.07 INSURANCE MAINTAINED BY THE CITY**

Miscellaneous Insurance. The City shall at all times carry with a responsible insurance company or companies authorized and qualified under the laws of the State to assume the risk thereof:

(A) Fire and Extended Coverage Insurance. From and after the time when any contractors engaged in connection with the Airport, or any part thereof, shall cease to be responsible pursuant to the provisions of their respective contracts for loss or damage thereto occurring from any cause, the City shall insure and at all times keep the Airport insured to the extent possible with a responsible insurance company, companies or carriers authorized and qualified under the laws of the State of Colorado assume the risk thereof against direct physical damage or loss from fire and so-called extended coverage perils in an amount not less than 80% of the replacement value of the Facilities so insured, less depreciation; but such amount of insurance shall at all times be sufficient to comply with any legal or contractual requirement which, if breached, would result in assumption by the City of a portion of any loss or damage as co-insurer; and also if at any time the City shall be unable to obtain such insurance to the extent above required at reasonable cost as determined by the Manager, the City shall maintain such insurance to the extent reasonably obtainable. Insurance against any other risks or type of loss as are or shall be customarily covered may be obtained, under a standard "all risk policy" with extended coverage for public property, or otherwise, including, without limitation, insurance against loss or damage to the Airport by flood or other waters, elements of weather, explosion of any nature, earthquake, and volcanic eruption (or any combination thereof), when, if, and to the extent any such insurance can be procured at reasonable rates in the sole opinion of the Manager.

(B) Loss of Use Insurance. To the extent not provided for in leases and other agreements between the City and others relating to the Airport, insurance covering loss of revenues from Airport facilities by reason of necessary interruption, total or partial, in the use thereof, resulting from damage thereto or destruction thereof, however caused, in such amount as is estimated to be sufficient to provide a full normal income during the period of suspension; but

(1) Such insurance shall cover a period of suspension of the period of reconstruction as estimated by the Airport Engineer, but not less than twelve months;

(2) Such insurance may exclude losses sustained by the City during the first seven days of any total or partial interruption of use; and

(3) If at any time the City shall be unable to obtain such insurance to the extent above required, it shall carry such insurance to the extent reasonably obtainable at reasonable rates in the sole option of the Manager.

In any calculation of the full normal income for such insurance, consideration shall be given to the expected, as well as current and prior, revenues from such Airport facilities, or from other sources, and may also make allowances for any probable decrease in the operation and maintenance expenses or any other charges and expenses while use is interrupted. Any proceeds of such insurance shall be deposited to the credit of the Revenue Fund and shall be subject to the uses of and shall be applied as provided for moneys in the Revenue Fund.

(C) Liability Insurance. Insurance in the form and amount recommended by the Manager and reasonably sufficient to insure against liability to any individual sustaining bodily injury or any person sustaining property damage or the death of any individual by reason of any defect or want of repair in or about the Airport, or by reason of the negligence of any employees, and against such other liability for individuals, including workmen's compensation insurance, to the extent attributed to ownership and operation of the Airport, and damage to property of persons; but in the case of the company or companies insuring the Airport under a general liability policy against loss from bodily injury or property damage, or both, the total liability of such company or companies for all damages because of all bodily injury and all property damage arising out of continuous or repeated exposure to substantially the same general conditions to which the policy applies as the result of any one occurrence, subject to such exclusions generally made to such a policy, shall be not less than \$75,000,000.00 under a single limit of liability endorsement or other like provision of the policy, regardless of the number of:

- (1) Insureds under the policy,
- (2) Individuals who sustain bodily injury or persons who sustain property damage,
- (3) Claims made or suits brought on account of bodily injury or property damage, or
- (4) Occurrences.

(D) Maintenance of Policies. All such insurance policies designated in Subparagraphs (A) and (B) hereof shall be filed with the Manager and shall be subject to inspection at all reasonable times by Airline. If the Manager determines that certain insurance required in Subparagraphs (A) and (B) hereof cannot be obtained to the extent therein required at reasonable rates, the Manager shall prepare a written memorandum to that effect, designating each such type of insurance in question and stating in each such case that the insurance was not obtainable or that designated insurance was required in substitution for the required insurance, the reason or reasons for its substitution, and when and to the extent that the substituted insurance was procured at reasonable rates, as the case may be. Each such memorandum shall be filed with the policies on file with the Manager and shall also be subject to such inspection.

**PART IX**  
**QUIET ENJOYMENT; INCONVENIENCE DURING CONSTRUCTION**

**9.01 COVENANT OF QUIET ENJOYMENT**

Upon the payment by Airline of all rentals, rates, fees and charges properly assessed to Airline and the performance of the covenants and agreements on the part of Airline to be performed hereunder, Airline shall peacefully have and enjoy the premises, appurtenances, facilities, licenses and privileges granted herein; provided, however, it is recognized that certain temporary inconveniences may occur during construction.

**9.02 INCONVENIENCE DURING CONSTRUCTION**

The Airline recognizes that from time to time during the term of this Agreement it will be necessary for the City to initiate and carry forward extensive programs of construction, reconstruction, expansion, relocation, maintenance and repair in order that the Airport and its facilities may be suitable for the volume and character of air traffic and flight activity which will require accommodation, and that such construction, reconstruction, expansion, relocation, maintenance and repair may inconvenience the Airline in its operations at the Airport. The City shall consult with Airline prior to taking any such action which would adversely affect the Airline's operations at the Airport unless such action is necessitated by circumstances which in the opinion of the Manager pose an immediate threat to the health and safety of persons using the Airport. The Airline agrees that no liability shall attach to the City, its officers, agents, employees, contractors, subcontractors and representatives by reason of minor inconvenience or minor discomfort as a result of such action and, for and in further consideration of the lease of the Demised Premises, the Airline waives any right to claim damages or other consideration for such minor inconvenience of minor discomfort.

**PART X**  
**MISCELLANEOUS PROVISIONS**

**10.01 LEASE BINDING**

This Agreement shall be binding on and extend to any successors of the respective parties hereto.

**10.02 PARAGRAPH HEADINGS AND INDEX**

The paragraph or Section headings and index or table of contents contained herein are for convenience and reference only and are not intended to define or limit the scope of any provision of this Agreement.

**10.03 SIGNS**

The Airline agrees that no signs or advertising displays shall be painted on or erected in any manner upon its Demised Premises without the prior written approval of the Manager or the Manager's authorized representative; and that signs identifying the Airline, or for any other purpose, will conform to reasonable standards established by the Manager, or the Manager's

authorized representative, with respect to type, size, design, location, and content. The initial Airline directional signage package (roadway, Terminal, Concourse and directory) is provided by the City. All subsequent revisions and installations are at Airline's expense unless required pursuant to paragraph 4.08 herein.

#### **10.04 VENDING MACHINES**

No telecommunication devices, personal computers, amusement or vending machines or similar machines operated by coins or tokens, credit cards, paper currency, or any imaging or voice process, and no cash machines or pay telephones shall be installed or maintained in or upon the Airline's Demised Premises except with the permission of the Airline and the Manager and the number, type, kind and locations thereof shall be in the discretion of the Manager and the Airline. This prohibition includes, but not by way of limitation, sales from vending machines of such items as cigarettes, candy, maps, coffee, soft drinks, newspapers, stamps and insurance policies; telephones; dispensation of cash, money orders and checks; and operation of mechanical or electronic game devices, electronic video games, entertainment devices, phone cards and internet access. The Airline shall not permit the installation of any such machines, except by a concessionaire authorized by the Manager and subject to and in accordance with the concessionaire's agreement with the City. If and when the Airline permits the installation of vending machines in its Demised Premises, the Airline shall make no charge to the concessionaire for the privilege of installing or maintaining such machines, except that if the Airline provides the electric current or water to the concessionaire a reasonable charge may be made to cover the cost of the electricity and water consumed, and all fees paid by the concessionaire for the privilege shall be the property of the City.

#### **10.05 SALE OF FOOD, BEVERAGES AND MERCHANDISE**

The Airline shall not sell, or permit the sale of food, food products, beverages (both alcoholic and non-alcoholic) or merchandise upon the Preferential Use Facilities and Demised Premises occupied by it except by a concessionaire to whom the City has granted the right to provide such services in said Preferential Use Facilities and Demised Premises and except that, with respect to its Demised Premises, Airline may sell, or permit the sale of, such items on its own behalf or by a concessionaire selected by Airline. Airline agrees to pay the same fees and charges that would be applicable to an Airport concessionaire with respect to the sale of such products.

#### **10.06 PURCHASES BY AIRLINE**

Property, services and materials (except as otherwise provided in this Lease) may be purchased or otherwise obtained by the Airline from any person or corporation of its choice and no unjust or unreasonable discriminatory limitations, restrictions, charges or conditions shall be imposed by the City, directly or indirectly, against the Airline or its suppliers for the privilege of purchasing, selling, using, storing, withdrawing, handling, consuming, loading, unloading, or delivering any personal property of the Airline, by the Airline or its suppliers, or for the privilege of transporting such personal property to, from or on the Airport.

## 10.07 NON-DISCRIMINATION

The Airline, for itself, its successors and assigns, as a part of the consideration hereof does hereby agree as follows:

(A) As more fully set forth in Appendix 1 attached hereto and incorporated herein by reference, if facilities are constructed, maintained or otherwise operated on the Demised Premises for purposes in which federal financial assistance is extended under a Department of Transportation program or activity, or for another purpose involving the provision of a similar service or benefit, the Airline shall maintain and operate such facilities and services in compliance with all requirements of 49 C.F.R. Part 21, Nondiscrimination in Federally Assisted Programs of the Department of Transportation - Effectuation of Title VI of the Civil Rights Act of 1964, and as said regulations may be amended.

(B) The Airline will in all of its operations and activities in and at the Airport comply with all requirements of the Air Carrier Access Act, 49 U.S.C. § 41705, and regulations implementing such Act at 14 C.F.R. Part 382, and the Americans with Disabilities Act, 42 U.S.C. § 12101 et seq. and all regulations implementing such Act.

## 10.08 NO PERSONAL LIABILITY

No director, officer or employee of either party shall be held personally liable under this Agreement or because of its execution or attempted execution.

## 10.09 NOTICES

All notices required to be given to the City hereunder shall be in writing and shall be sent by certified mail, return receipt requested, addressed to:

Manager of Aviation Denver International Airport 8500 Peña Boulevard, AOB 9 <sup>th</sup> Floor Denver, Colorado 80249-6340	and	Asset Development Section Manager, Airlines Denver International Airport 8500 Peña Boulevard, AOB, 9 <sup>th</sup> Floor, Room 9870 Denver, Colorado 80249-6340
--	-----	--

All notices required to be given to the Airline hereunder shall be in writing and shall be sent by certified mail, return receipt requested, addressed to:

Vice President - Real Estate  
American Airlines, Inc.  
4333 Amon Carter Blvd, MD 5317  
Fort Worth, TX 76155

provided that the parties or either of them, may designate in writing from time to time the addresses of substitute or supplementary persons in connection with said notices. The effective date of service of any such notice shall be the date such notice is mailed to the Airline or said Manager.

## **10.10 PLACE AND MANNER OF PAYMENTS**

In all cases where the Airline is required by this Agreement to pay any rentals, fees or other charges or to make other payments to the City, such payments shall be due and payable without notice and shall be sent to: Airport Revenue Fund, Denver International Airport, P. O. Box 492065, Denver, Colorado 80249-2065, overnight express mail shall be addressed to: Airport Revenue Fund, Denver International Airport, Attn. Accounts Receivable, 8500 Peña Boulevard, Denver, CO 80249-6340 or at such other place in the City and County of Denver as the City may hereafter designate by notice in writing to the Airline. All payments shall be made in legal tender of the United States. Any check or electronic payment shall be received by the City subject to collection, and the Airline agrees to pay any bank charges for use of electronic payment methods or for the collection of any payments.

Any payment not made to the City or Airline when due shall accrue interest at the rate of 18% per annum commencing five (5) business days after such due date.

## **10.11 SEVERABILITY**

In the event any covenant, condition or provision contained in this Agreement is held by any court of competent jurisdiction to be invalid, the invalidity of any such covenant, condition or provision shall in no way affect any other covenant, condition or provision herein contained if the invalidity of any such covenant, condition or provision does not materially prejudice either party hereto in its respective rights and obligations contained in the valid covenants, conditions or provisions in this Agreement.

## **10.12 SECURITY**

It is understood and agreed by the Airline that in addition to the Airline's responsibilities to maintain the Preferential Use Facilities and Demised Premises as provided herein, it shall take reasonable security precautions to use and maintain the Preferential Use Facilities, Demised Premises, and Baggage System in a manner as to keep them secure from unauthorized intrusion and shall with respect to any area of the premises opening to an air operations area of the airport provide for an adequate security system designed to prevent unauthorized persons or vehicles from entering such air operations area. An "air operations area" is defined to mean any area of the Airport used or intended to be used for landing, takeoff or surface maneuvering of aircraft. An "adequate security system" is further defined as providing for security at a standard no less than required and set out in Transportation Security Administration (TSA) regulations, including 49 CFR, Subtitle B, Chapter XII, as it may be amended, or any similar law or regulations intended to replace or compliment such regulations.

It is further understood and agreed by the Airline that at any time during the term hereof when requested in writing by the Manager or his authorized representative, the Airline shall submit to the Manager the security plans that are to be used and are being used by the Airline on any or all of the Preferential Use Facilities and Demised Premises.

## **10.13 WAIVERS**

No waiver of default by either party of any of the terms, covenants or conditions hereof to be performed, kept and observed by the Airline or the City shall be construed, or operate, as a waiver of such term, covenant, or condition or of any subsequent breach of the same or any other term, covenant or condition herein contained to be performed, kept and observed by the Airline or the City.

The subsequent acceptance of rent hereunder by the City shall not be deemed to be a waiver of any preceding breach by the Airline of any term, covenant or condition of this Agreement other than the failure of the Airline to pay the particular rental so accepted, regardless of the City's knowledge of such preceding breach at the time of acceptance of such rent.

#### **10.14 AIRLINE BOOKS AND RECORDS**

The Airline agrees that the Manager and the Auditor of the City or any of their duly authorized representatives, until the expiration of three (3) years after the termination of this Agreement, shall have the right, at any reasonable time and at their own expense, to have access to and the right to examine any books, documents, papers and records of the Airline pertinent to this Agreement. The Airline, upon request by either, shall make all such books and records available for examination and copying in Denver.

#### **10.15 CITY BOOKS AND RECORDS**

The City shall follow such procedures and keep and maintain in Denver such books, records and accounts as are necessary or required under the provisions of this Agreement or the General Bond Ordinance. Such books, records and accounts shall contain all items affecting the computation of airline rentals, rates, fees and charges, recorded in accordance with reasonable accounting principles or procedures. Airline shall have the right, at any reasonable time and at its own expense, until the expiration of three (3) years after the termination of this Agreement, to examine and make copies of the City's books, records and accounts pertinent to the Agreement.

#### **10.16 CITY SMOKING POLICY**

The Airline agrees that it will prohibit smoking by its employees and the public in the Demised Premises and will not sell or advertise tobacco products. Airline acknowledges that smoking is not permitted in Airport buildings and facilities except for designated smoking lounges. The Airline and its officers, agents and employees shall cooperate and comply with the provisions of the City's Executive Order No. 99 dated December 1, 1993, Executive Order No. 13 dated July 31, 2002, the provisions of Denver Revised Municipal Code, §§ 24-301 to 317 et. seq., and the Colorado Clean Indoor Air Act, C.R.S. §§ 25-14-201 et. seq.

#### **10.17 USE, POSSESSION OR SALE OF ALCOHOL OR DRUGS**

The Airline and its officers, agents and employees shall cooperate and comply with the provisions of Denver Executive Order No. 94 dated October 29, 2002, and Attachment A thereto, or any successor executive order concerning the use, possession or sale of alcohol or drugs.

#### **10.18 THIRD PARTIES**

This Agreement does not, and shall not be deemed or construed to, confer upon or grant to any third party or parties (excepting parties to whom the Airline may assign this Agreement in accordance with Section 4.03 hereof, and excepting any successor to the City) any right to claim damages or to bring any suit, action or other proceeding against either the City or the Airline because of any breach hereof or because of any of the terms, covenants, agreements and conditions herein contained.

#### **10.19 SUPPLEMENTAL INFORMATION TO BE SUPPLIED BY AIRLINE**

Not later than fifteen (15) calendar days after the end of each month, the Airline shall complete and file with the City written activity reports for the preceding month on forms provided by the City. Information to be provided will include, but not be limited to; flight, passenger, freight and mail information as well as any non-preferential gate and custom use and remain overnight (RON) activity. Flight information will include, but not be limited to, number of flights in and out, revenue and non-revenue, and Domestic and International flights. Passenger information will include, but not be limited to, the number of passengers in the following categories: originating, deplaned destination, transfers in and out, revenue and non-revenue, and Domestic and International passengers. In addition, if an airline operates on multiple concourses, separate passenger information will be required for each respective concourse from which it operates.

#### **10.20 CITY NON-DISCRIMINATION**

In connection with the performance of work under this Agreement, the Airline agrees not to refuse to hire, discharge, promote or demote, or to discriminate in matters of compensation against any person otherwise qualified, solely because of race, color, religion, national origin, gender, age, military status, sexual orientation, marital status, or physical or mental disability. The Airline further agrees to insert the foregoing provision in all subleases hereunder.

#### **10.21 DISPUTES**

It is agreed and understood by the parties hereto that disputes under or related to this Agreement shall be resolved by administrative hearing which shall be conducted in accordance with the procedures set forth in Section 5-17, Revised Municipal Code of the City and County of Denver, or such other substantially similar ordinance as may be adopted hereafter by the City. The City, however, shall retain its right to obtain an order of eviction in accordance with applicable state laws. The parties hereto agree that the Manager's determination resulting from said administrative hearing shall be final, subject only to the right of the parties to appeal the determination under Colorado Rule of Civil Procedure 106, or subject to rights under federal law.

#### **10.22 AMENDMENTS TO EXHIBITS AND APPENDICES**

The parties acknowledge that the rights and obligations of each of them as set forth in this Agreement will extend over a period of years. The Exhibits and Appendices hereto are intended to set forth the parties' current understandings and expectations with respect to the intended leasehold interests and such understandings and expectations may change over time. Therefore, the Manager is expressly authorized to make adjustments to such exhibits and appendices from



time to time to reflect agreed-upon changes, without affecting the underlying rights and obligations as set forth herein. Any such adjustments shall be evidenced in writing.

#### **10.23 ENTIRE AGREEMENT; AMENDMENT**

The parties acknowledge and agree that the provisions contained in this Agreement constitute the entire agreement and understanding between the parties with respect to the subject matter thereof, and that all representations made by any officer, agent or employee of the respective parties, unless included herein, are null and void and of no effect. This Agreement cannot be changed or terminated orally. No alterations, amendments, changes or modification, unless expressly reserved to the Manager herein, shall be valid unless executed by an instrument in writing by all the parties with the same formality as this Agreement.

#### **10.24 CONDITION; FINAL APPROVAL**

This Agreement is expressly subject to, and shall not be or become effective or binding on the City until approved by Denver City Council and fully executed by all signatories of the City and a fully executed copy has been delivered to Airline. This Agreement may be signed electronically by either party in the manner specified by the City.

**END OF DOCUMENT**

**SIGNATURE PAGES FOLLOW**

## APPENDIX NO. 1

### STANDARD FEDERAL ASSURANCES AND NONDISCRIMINATION

NOTE: As used below the term "contractor" shall mean and include the Airline, and the term "sponsor" shall mean the "City".

During the term of this contract, the contractor, for itself, its assignees and successors in interest (hereinafter referred to as the "contractor") agrees as follows:

1. Compliance with Regulations. The contractor shall comply with the Regulations relative to nondiscrimination in federally assisted programs of the Department of Transportation (hereinafter "DOT") Title 49, Code of Federal Regulations, Part 21, as they may be amended from time to time (hereinafter referred to as the Regulations), which are herein incorporated by reference and made a part of this contract.

2. Nondiscrimination. The contractor, with regard to the work performed by it during the contract, shall not discriminate on the grounds of race, creed, color, sex, national origin in the selection and retention of subcontractors, including procurements of materials and leases of equipment. The contractor shall not participate either directly or indirectly in the discrimination prohibited by section 21.5 of the Regulations, including employment practices when the contract covers a program set forth in Appendix B of the Regulations.

3. Solicitations for Subcontractors, Including Procurements of Materials and Equipment. In all solicitations either by competitive bidding or negotiation made by the contractor for work to be performed under a subcontract, including procurements of materials or leases of equipment, each potential subcontractor or supplier shall be notified by the contractor of the contractor's obligations under this contract and the Regulations relative to nondiscrimination on the grounds of race, color, or national origin.

4. Information and Reports. The contractor shall provide all information and reports required by the Regulations or directives issued pursuant thereto and shall permit access to its books, records, accounts other sources of information, and its facilities as may be determined by the sponsor or the Federal Aviation Administration (FAA) to be pertinent to ascertain compliance with such Regulations, orders, and instructions. Where any information required of a contractor is in the exclusive possession of another who fails or refuses to furnish this information, the contractor shall so certify to the sponsor of the FAA, as appropriate, and shall set forth what efforts it has made to obtain the information.

5. Sanctions for Noncompliance. In the event of the contractor's noncompliance with the nondiscrimination provisions of this contract, the sponsor shall impose such contract sanctions as it or the FAA may determine to be appropriate, including, but not limited to:

a. Withholding of payments to the contractor under the contract until the contractor complies, and/or

b. Cancellation, termination, or suspension of the contract, in whole or in part.

6. Incorporation of Provisions. The contractor shall include the provisions of paragraphs 1 through 5 in every subcontract, including procurements of materials and leases of equipment, unless exempt by the Regulations or directives issued pursuant thereto. The contractor shall take such action with respect to any subcontract or procurement as the sponsor or the FAA may direct as a means of enforcing such provisions including sanctions for noncompliance. Provided, however, that in the event a contractor becomes involved in, or is threatened with, litigation with a subcontractor or supplier as a result of such direction, the contractor may request

the sponsor to enter into such litigation to protect the interests of the sponsor and, in addition, the contractor may request the United States to enter into such litigation to protect the interests of the United States.

7. The Airline for itself, representatives, successors in interest, and assigns, as a part of the consideration hereof, does hereby covenant and agree as a covenant running with the land that in the event facilities are constructed, maintained, or otherwise operated on the said property described in this agreement for a purpose for which a DOT program or activity is extended or for another purpose involving the provision of similar services or benefits, the Airline shall maintain and operate such facilities and services in compliance with all other requirements imposed pursuant to 49 CFR Part 21, Nondiscrimination in Federally Assisted Programs of the Department of Transportation, and as said Regulations may be amended.

8. The Airline for itself, representatives, successors in interest, and assigns, as a part of the consideration hereof, does hereby covenant and agree as a covenant running with the land: (1) that no person on the grounds of race, color, sex, creed or national origin shall be excluded from participation in, denied the benefits of, or be otherwise subjected to discrimination in the use of said facilities, (2) that in the construction of any improvements on, over, or under such land and the furnishing of services thereon, no person on the grounds of race, color, sex, creed or national origin shall be excluded from participation in, denied the benefits of, or otherwise be subjected to discrimination, (3) that the Airline shall use the premises in compliance with all other requirements imposed by or pursuant to 49 CFR Part 21, Nondiscrimination in Federally Assisted Programs of the Department of Transportation, and as said Regulations may be amended.

#### **9. NONDISCRIMINATION IN AIRPORT EMPLOYMENT OPPORTUNITIES**

The Airline assures that it will comply with pertinent statutes, Executive Orders and such rules as are promulgated to assure that no person shall, on the grounds of race, creed, color, national origin, sex, age, or handicap be excluded from participating in any activity conducted with or benefiting from Federal assistance.

It is unlawful for airport operators and their lessees, tenants, concessionaires and contractors to discriminate against any person because of race, color, national origin, sex, creed, or handicap in public services and employment opportunities.

## APPENDIX NO. 2

### **DISADVANTAGED BUSINESS ENTERPRISES - REQUIRED STATEMENTS**

Policy. It is the policy of the Department of Transportation that disadvantaged business enterprises as defined in 49 CFR Part 26 shall have the maximum opportunity to participate in the performance of contracts financed in whole or in part with federal funds under this agreement. Consequently, the DBE requirements of 49 CFR Part 26 apply to this agreement.

DBE Obligation. The City and its contractors agree to ensure that disadvantaged business enterprises as defined in 49 CFR Part 26 have the maximum opportunity to participate in the performance of contracts financed in whole or in part with federal funds provided under this agreement. In this regard, all recipients or contractors shall take all necessary and reasonable steps in accordance with 49 CFR Part 26 to ensure that disadvantaged business enterprises have the maximum opportunity to compete for and perform contracts. The City and its contractors shall not discriminate on the basis of race, color, sex, creed or national origin in the award and performance of DOT-assisted contracts.

49 CFR 26.5 defines a DOT-assisted contract as “any contract between a recipient and a contractor (at any tier) funded in whole or in part with DOT financial assistance, including letters of credit or loan guarantees.” “Contractor” means one who participates through a contract or subcontract (at any tier) in a DOT-assisted highway, transit, or airport program.

**Contract Control Number:** PLANE-201205587-00

**Contractor Name:** American Airlines, Inc.

By:   
Kevin E. Cox  
Vice President - Real Estate

Name: \_\_\_\_\_  
(please print)

Title: \_\_\_\_\_  
(please print)

**ATTEST: [if required]**

By:   
Kenneth W. Wimberly  
Corporate Secretary

Name: \_\_\_\_\_  
(please print)

Title: \_\_\_\_\_  
(please print)



**Contract Control Number:**

IN WITNESS WHEREOF, the parties have set their hands and affixed their seals at Denver, Colorado as of

SEAL

**CITY AND COUNTY OF DENVER**

ATTEST:

By \_\_\_\_\_

\_\_\_\_\_

APPROVED AS TO FORM:

REGISTERED AND COUNTERSIGNED:

By \_\_\_\_\_

By \_\_\_\_\_

By \_\_\_\_\_



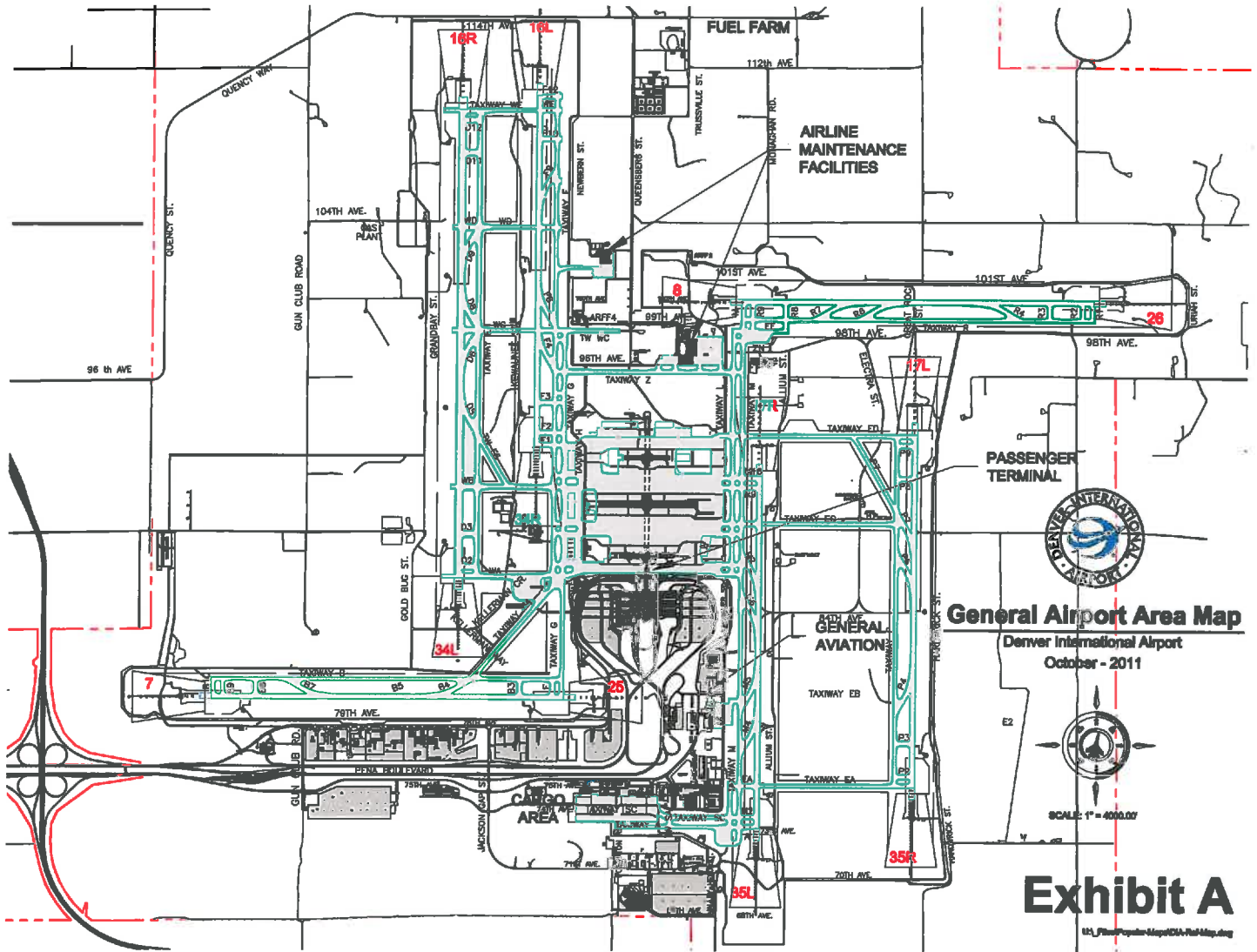

**General Airport Area Map**  
 Denver International Airport  
 October - 2011



SCALE: 1" = 4000.00'

**Exhibit A**

USA\_FlightOperationsMap\GCA-FuelMap.dwg

**EXHIBIT B [RESERVED]**



American

138.4'

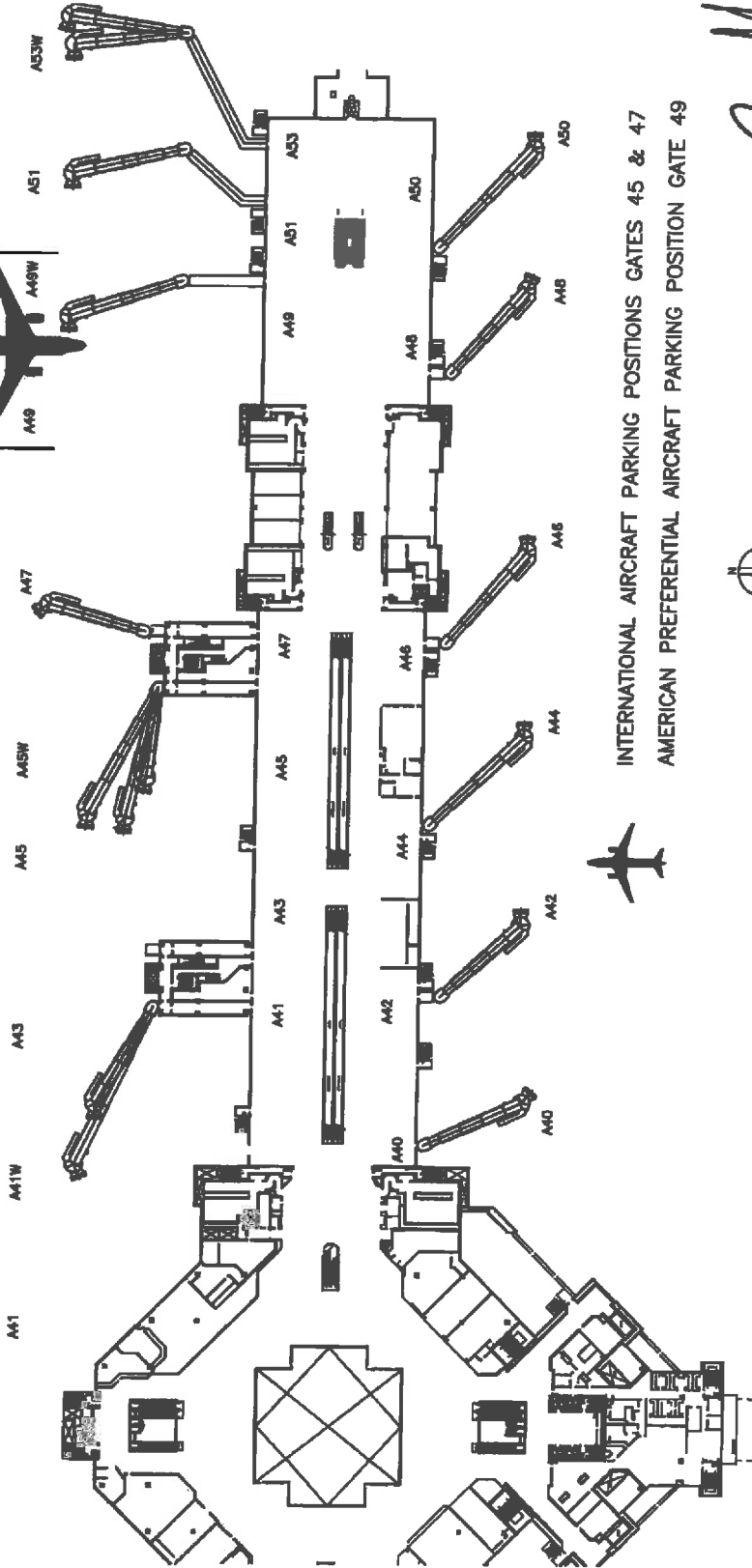



INTERNATIONAL AIRCRAFT PARKING POSITIONS GATES 45 & 47  
AMERICAN PREFERENTIAL AIRCRAFT PARKING POSITION GATE 49



SCALE 1" = 120'

*Frank Korn*  
MANAGER OF DESIGN

NOTE: This exhibit depicts only square footage of leased area based upon planning data and is not intended to address construction details.

	REVISID	DENVER INTERNATIONAL AIRPORT
		EXHIBIT C PARKING POSITIONS AMERICAN AIRLINES
	KEY PLAN CONCOURSE A	CC#: AMAL
		DATE: 07/12/12

American 186.8'

American 133.0'

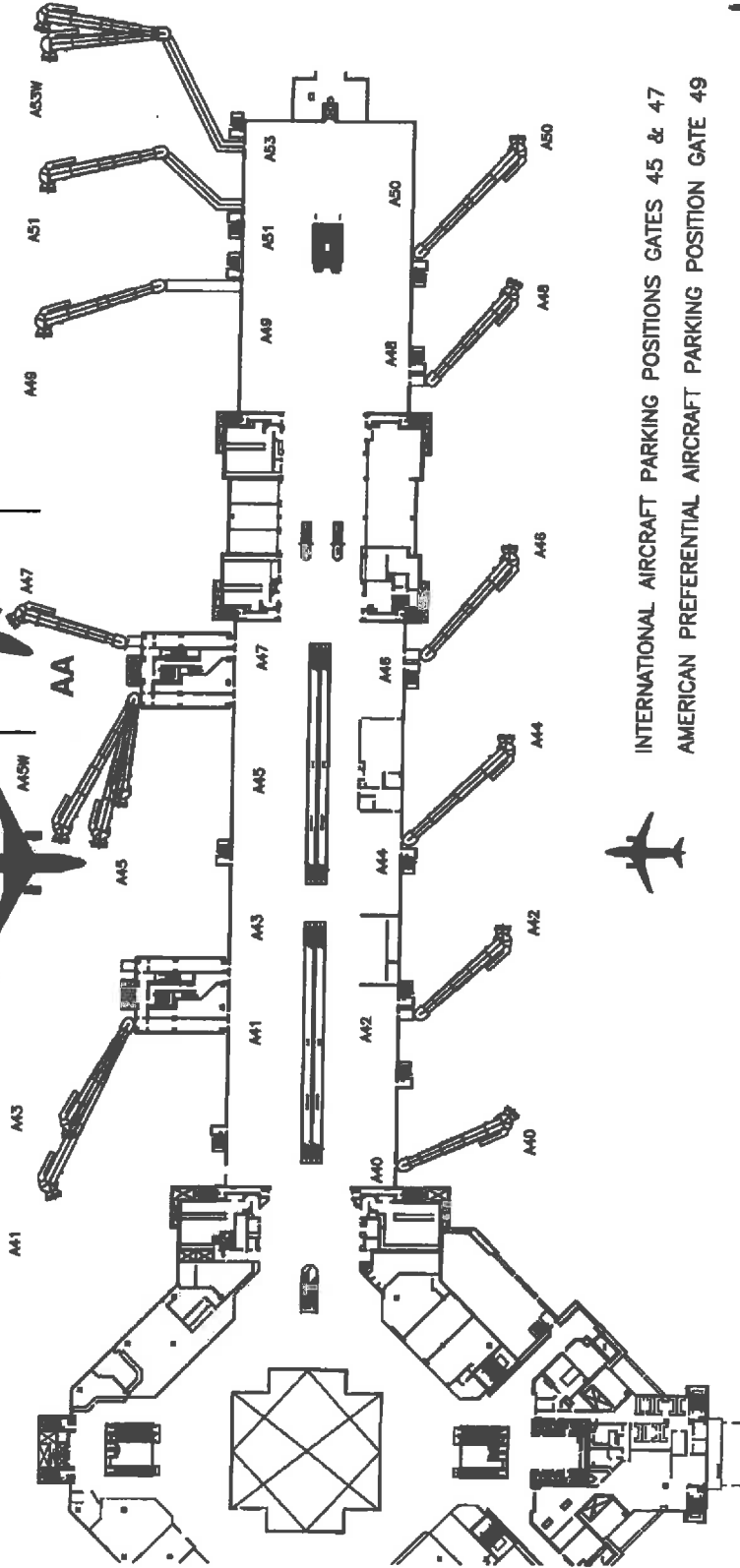

INTERNATIONAL AIRCRAFT PARKING POSITIONS GATES 45 & 47  
 AMERICAN PREFERENTIAL AIRCRAFT PARKING POSITION GATE 49





SCALE 1" = 120'

*R. K. Koon*  
 MANAGER OF DESIGN

NOTE: This exhibit depicts only square footage of leased area based upon planning data and is not intended to address construction details.

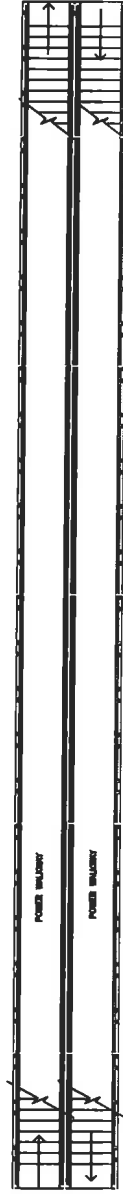
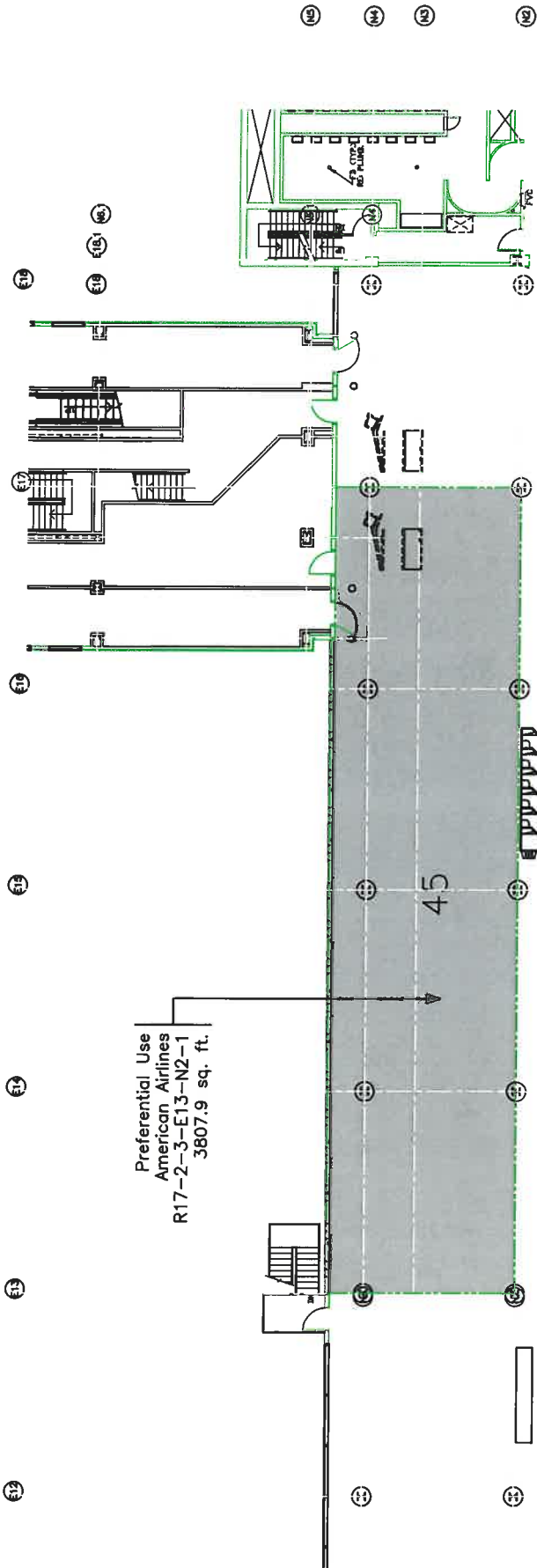
	REVISIONS	DENVER INTERNATIONAL AIRPORT
	KEY PLAN CONCOURSE A	EXHIBIT C INTERNATIONAL PARKING POSITIONS AMERICAN AIRLINES
	CC#: AMAL.	DATE: 07/12/12



  
 SCALE 1" = 20.00'
   

- CONC. WALL (BY CITY)
- STRUCTURAL WALL (BY CITY)
- SEAL (BY CITY)
- TRUSS (BY CITY)
- TRUSS LEASE LINE
- COLUMNS
- NIC = Not Included (By Location or Sq. Ft. Only)

  
 KEY PLAN CONCOURSE A



NOTE: This exhibit depicts only square footage of leased area based upon planning data and is not intended to address construction details.

REVISED	DENVER INTERNATIONAL AIRPORT
3/15/00	EXHIBIT D
2/19/10	Concourse A Conc. Level
	American Airlines
CC#: amal	DATE: 3/25/93

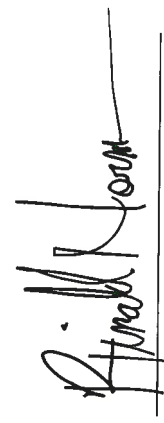
  
 MANAGER OF DESIGN

E16

GN1

GN2

E17

GN3

GN4

E18

E18.1

E18.6

E19

Effective January 1, 2012 to End of Term

N7.2

N6.8

N6.6

N6.1

N5

N4

N3

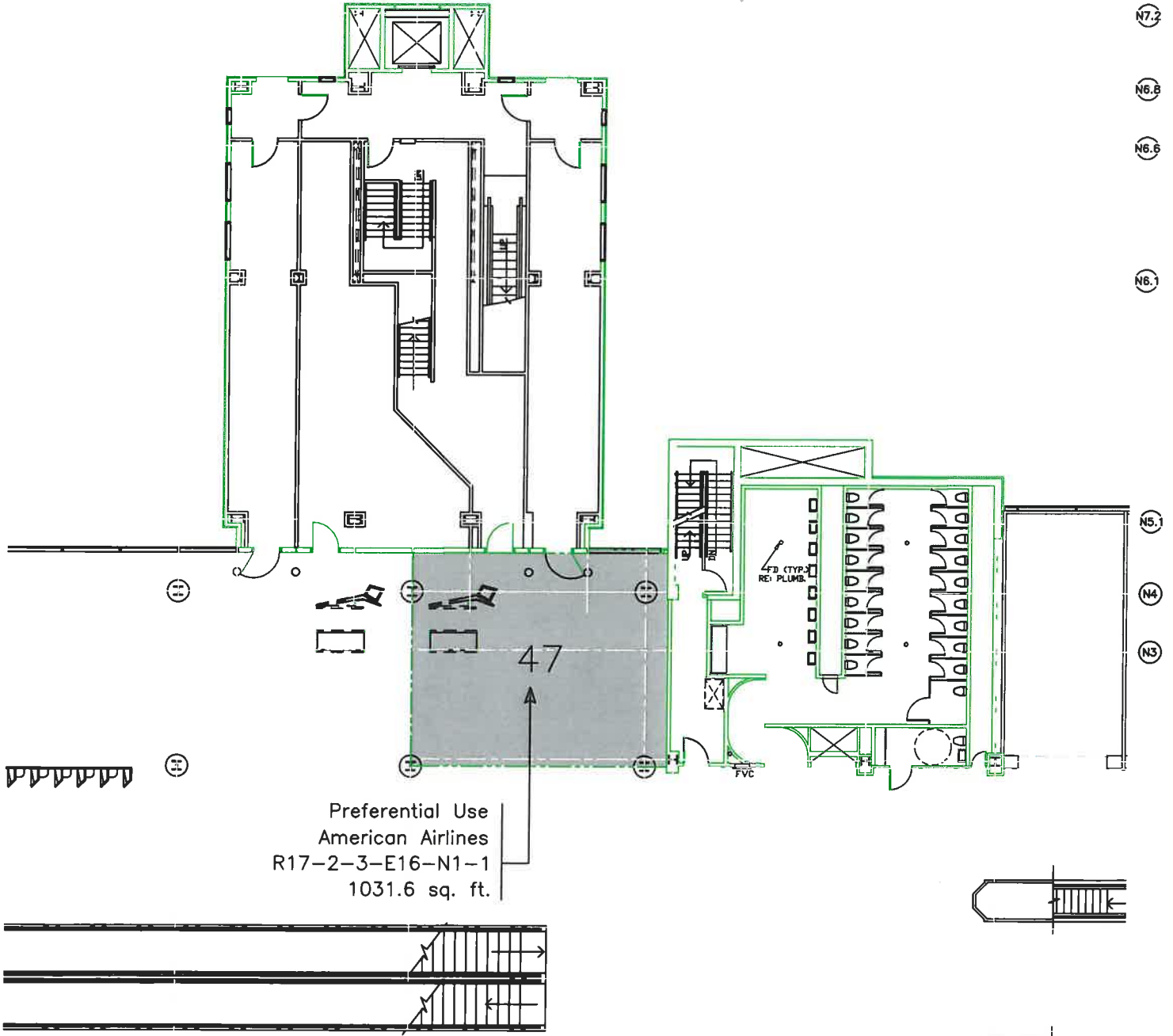

Preferential Use  
 American Airlines  
 R17-2-3-E16-N1-1  
 1031.6 sq. ft.

- CONC. WALL (BY CITY)
- STUD/GYPSUM WALL (BY CITY)
- GLASS WALL (BY CITY)
- TENANT LEASE LINE
- (H) (S) COLUMNS
- NIC = Not Included  
(In Lease or Sq. Ft. Calc.)

SCALE 1" = 20.00'



*Rinald*  
 MANAGER OF DESIGN

NOTE: This exhibit depicts only square footage of leased area based upon planning data and is not intended to address construction details.

<p>KEY PLAN CONCOURSE A</p>		REVISED	DENVER INTERNATIONAL AIRPORT
		3/15/00	EXHIBIT D
		2/19/10	Concourse A Conc. Level
			American Airlines
			CC#: amal
			DATE: 8/2/95

R17-2-3-2-9

Effective January 1, 2012 to End of Term

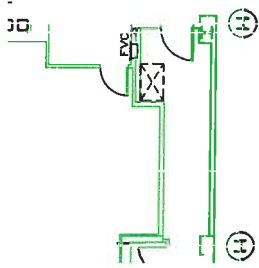
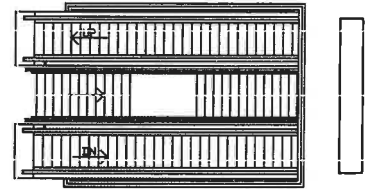
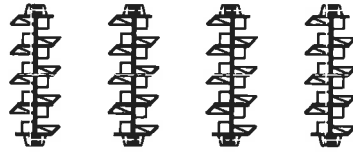
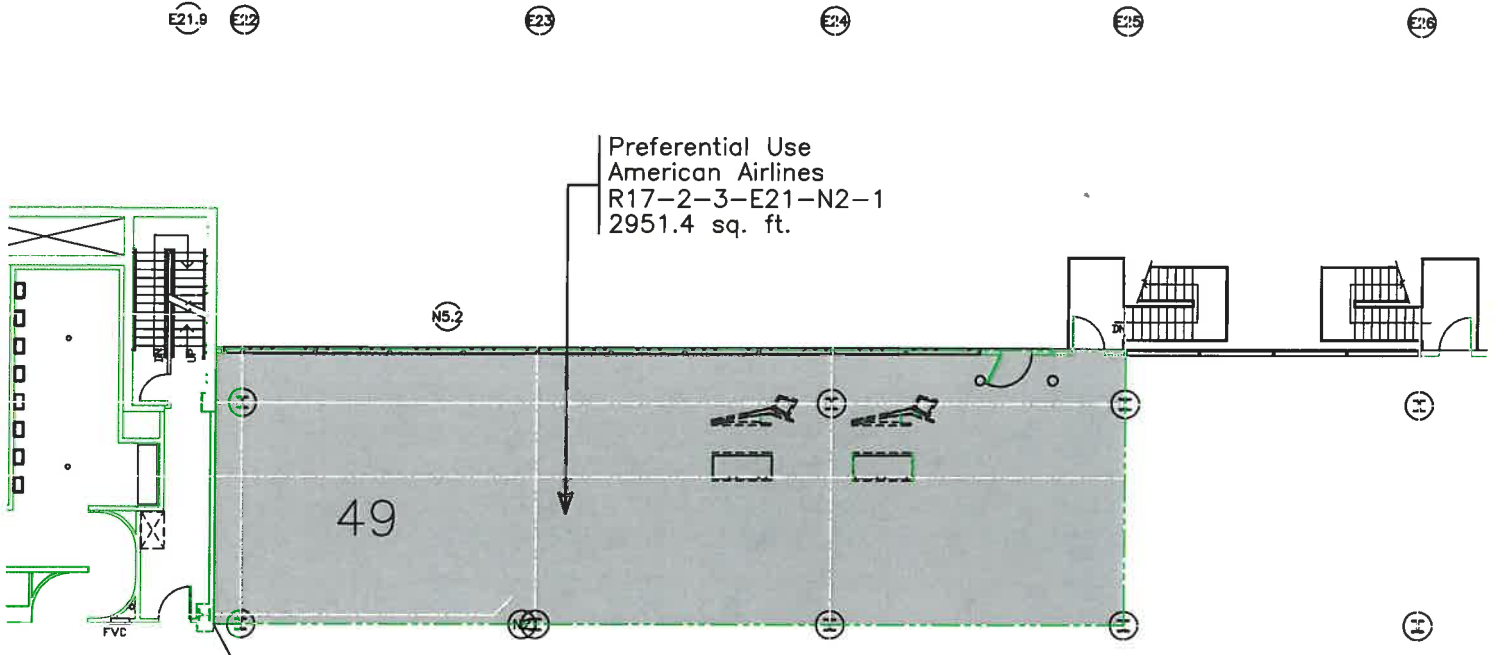

- CONG. WALL (BY CITY)
- STUD/GYPSUM WALL (BY CITY)
- GLASS WALL (BY CITY)
- TENANT LEASE LINE
- COLUMNS
- NIC = Not Included  
(In Lease or Sq. Ft. Calc.)

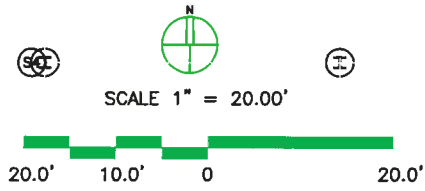

*Ronald Horn*  
 \_\_\_\_\_  
 MANAGER OF DESIGN

NOTE: This exhibit depicts only square footage of leased area based upon planning data and is not intended to address construction details.

 KEY PLAN CONCOURSE A		REVISED	DENVER INTERNATIONAL AIRPORT	
		3/15/00	EXHIBIT D	
		2/19/10	Concourse A Conc. Level American Airlines	
			CC#: amal	DATE: 9/20/95

Effective January 1, 2012 to January 31, 2013 or on date vacated by American, whichever is later.

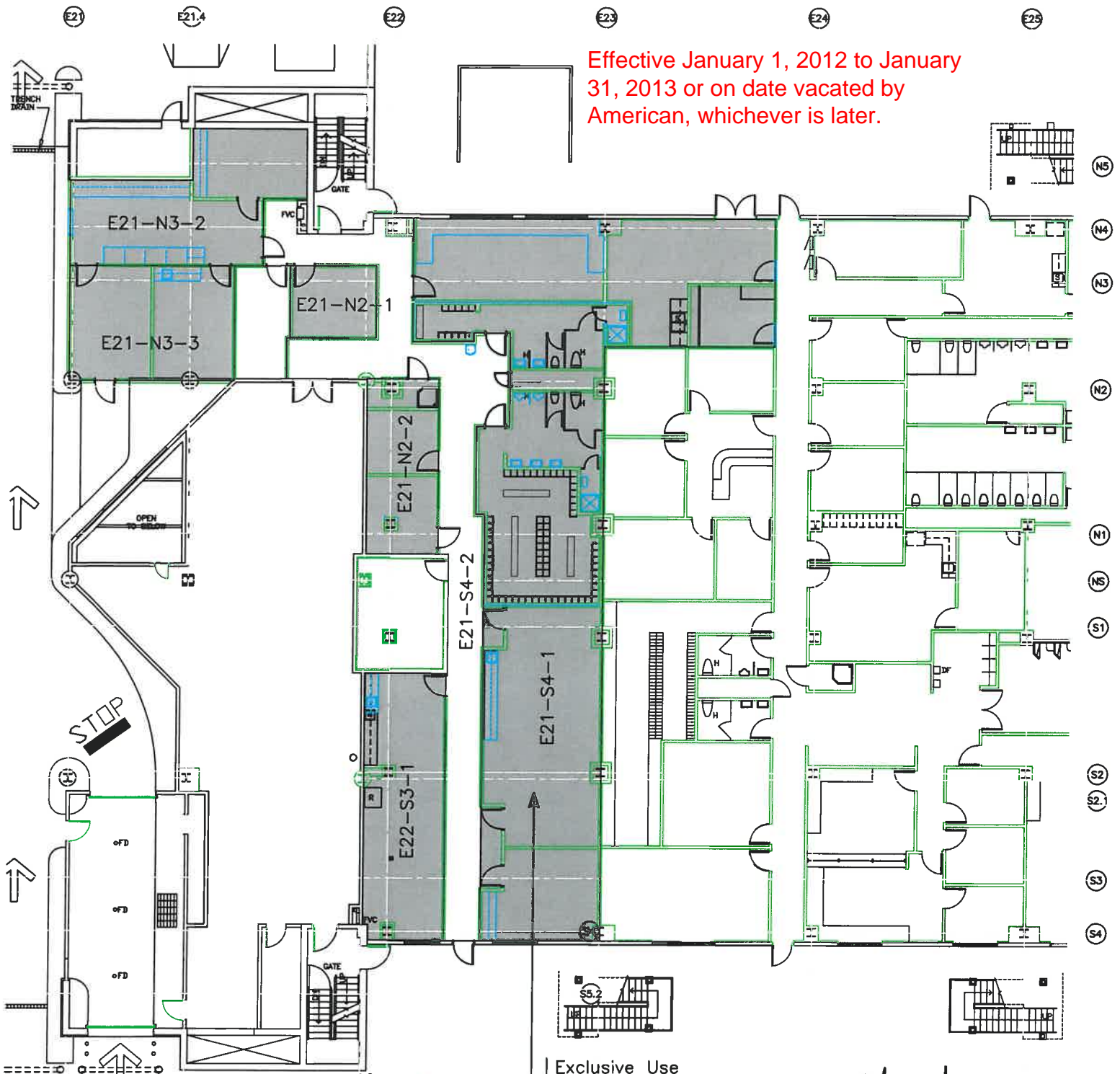

Exclusive Use  
American Airlines  
R17-2-2-E21-S4-1  
4476.9 sq. ft.

*Ronald Horn*  
MANAGER OF DESIGN

NOTE: This exhibit depicts only square footage of leased area based upon planning data and is not intended to address construction details.

<p>KEY PLAN CONCOURSE A</p>		REVISED	DENVER INTERNATIONAL AIRPORT
		EXHIBIT D Concourse A Apron Level American Airlines	
		CC#: amal	DATE: 03/03/10

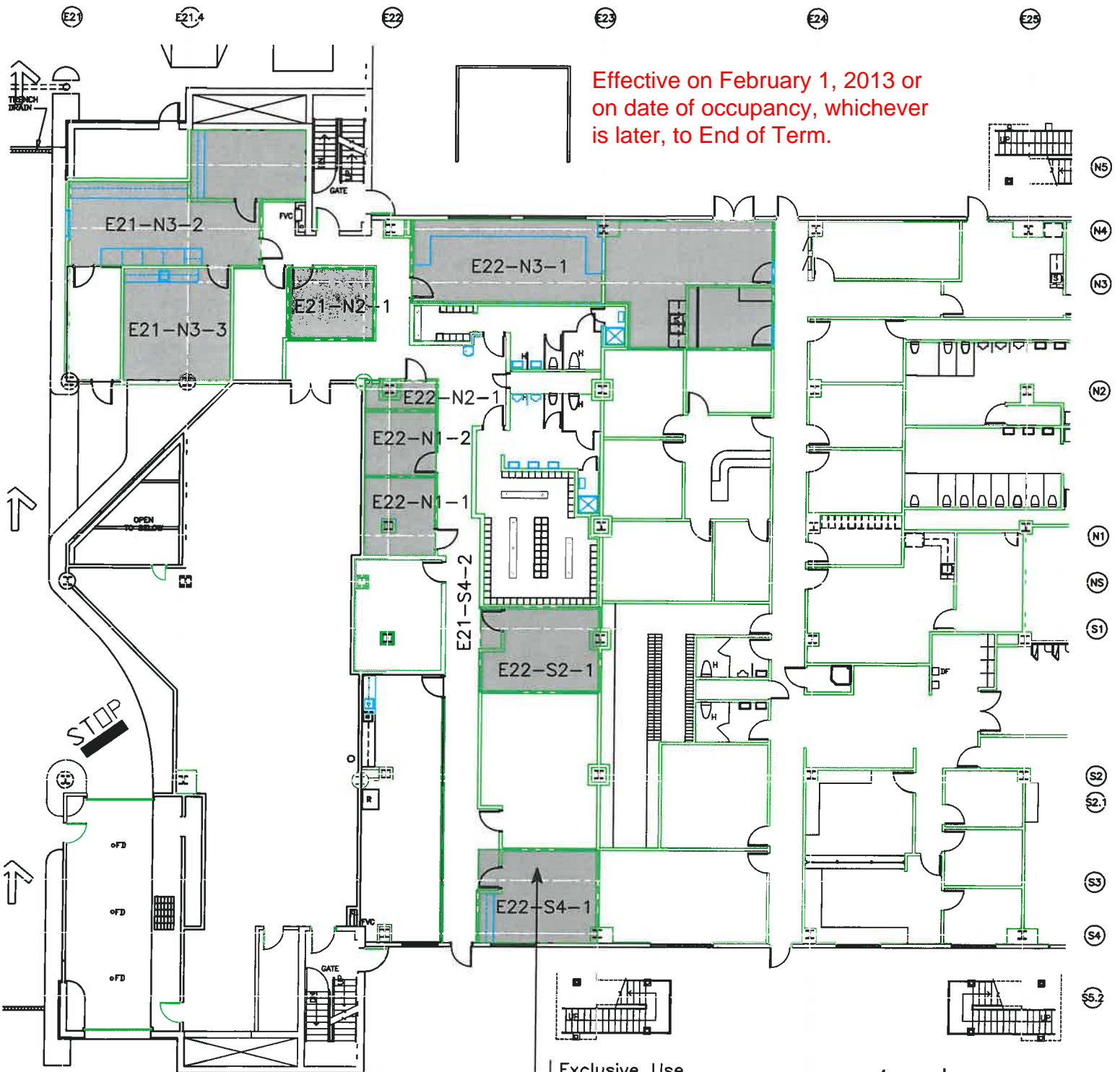

Effective on February 1, 2013 or on date of occupancy, whichever is later, to End of Term.

- CONC. WALL (BY CITY)
- STUD/GYPSUM WALL (BY CITY)
- GLASS WALL (BY CITY)
- TENANT LEASE LINE
- (H) (I) COLUMNS
- NIC = Not Included (In Lease or Sq. Ft. Calc.)



SCALE 1" = 20.00'

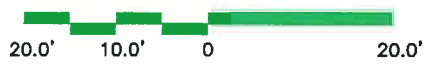

Exclusive Use  
American Airlines  
R17-2-2-E22-S4-1  
2545.4 sq. ft.

*Ronald Horn*  
MANAGER OF DESIGN

NOTE: This exhibit depicts only square footage of leased area based upon planning data and is not intended to address construction details.

<p>KEY PLAN CONCOURSE A</p>		REVISED	DENVER INTERNATIONAL AIRPORT	
		EXHIBIT D Concourse A Apron Level American Airlines		
		CC#: amal	DATE: 11/13/12	

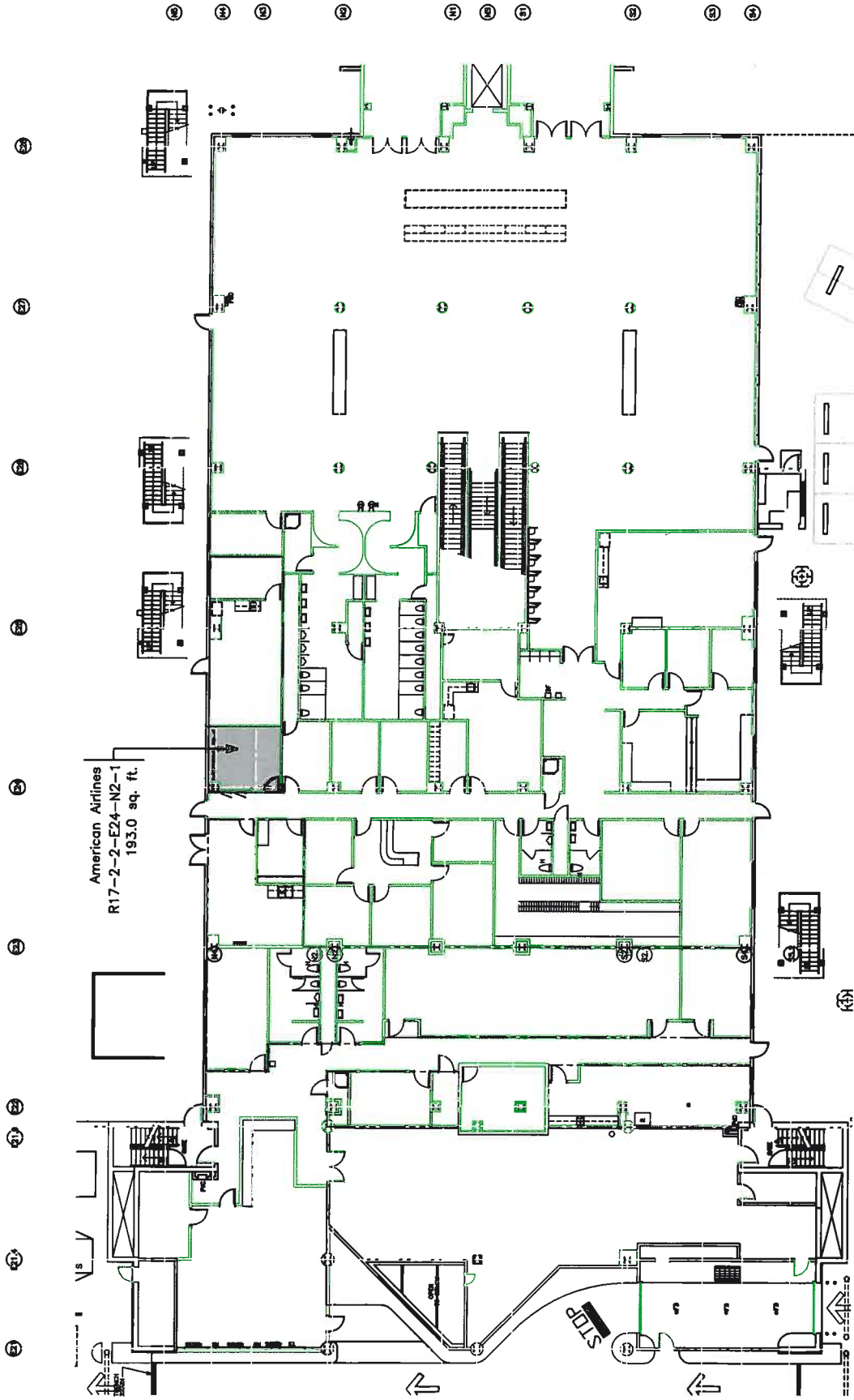





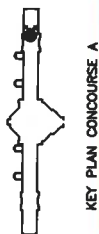

*Handwritten signature: R. Smith*

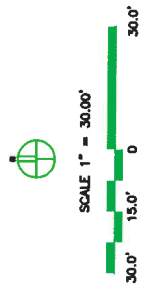
MANAGER OF DESIGN

NOTE: This exhibit depicts only square footage of leased area based upon planning data and is not intended to address construction details.

	REVISIONS	DENVER INTERNATIONAL AIRPORT	DATE: 9/3/10
		EXHIBIT D Concourse A Apron Level American Airlines	CO#:



-  CONCS. WALL (BY CITY)
-  STRUCT. WALL (BY CITY)
-  GLASS WALL (BY CITY)
-  TENANT LEASE LINE
-  COLUMNS
-  NIC = Not Included (in Lease or Sq. Ft. Count)



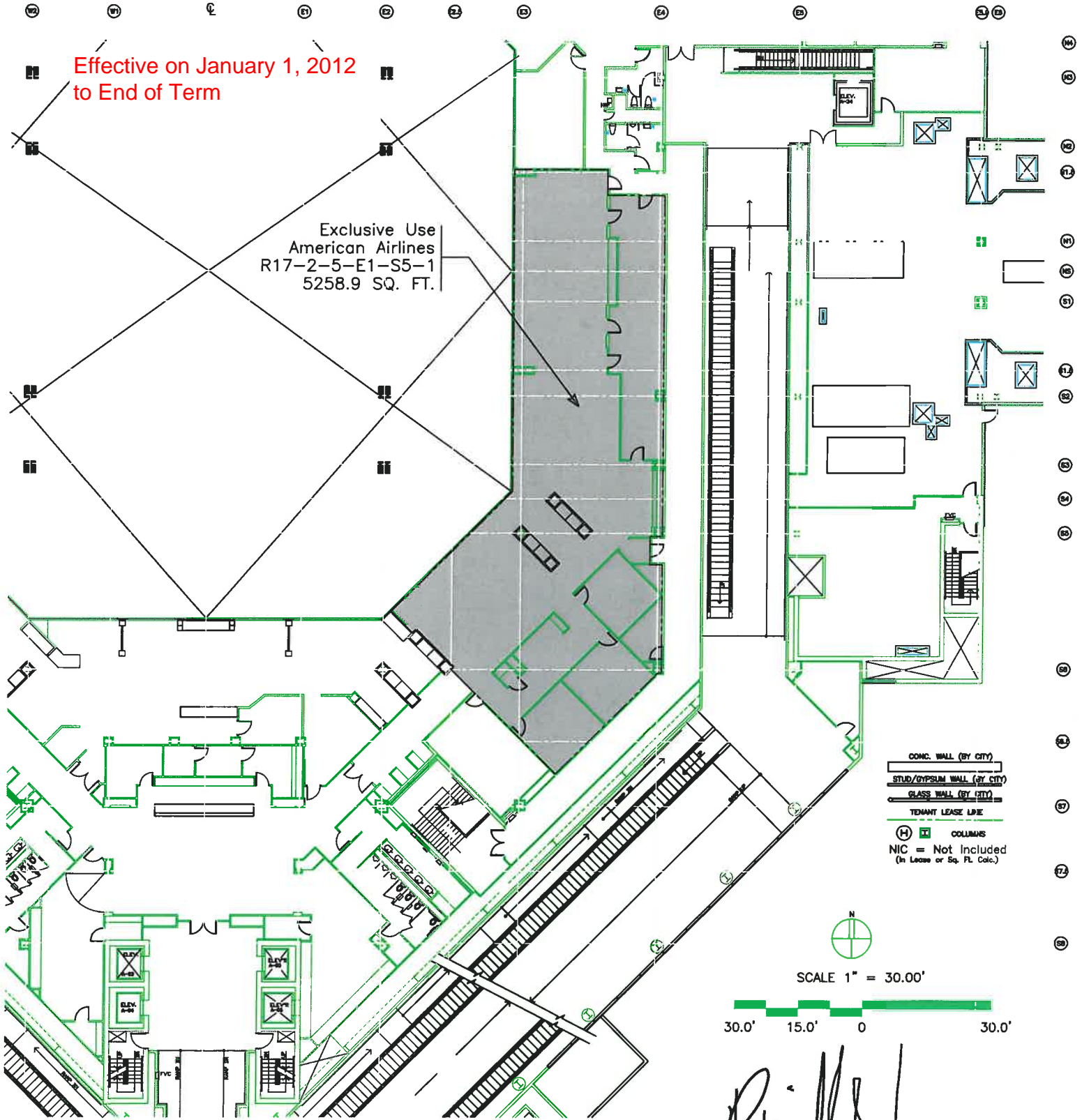

Effective on January 1, 2012  
to End of Term

Exclusive Use  
American Airlines  
R17-2-5-E1-S5-1  
5258.9 SQ. FT.



*Ronald Horn*  
MANAGER OF DESIGN

NOTE: This exhibit depicts only square footage of leased area based upon planning data and is not intended to address construction details.

 KEY PLAN CONCOURSE A		REVISED	DENVER INTERNATIONAL AIRPORT	
			EXHIBIT D Concourse A Level 5 American Airlines	
		CC#: amal	DATE: 2/24/10	

Effective on January 1, 2012 to  
End of Term.



American Airlines  
R17-2-5-E1-S8-4  
\* 584.4 sq. ft.

\*American has a  
1/3 share of the  
rest rooms.

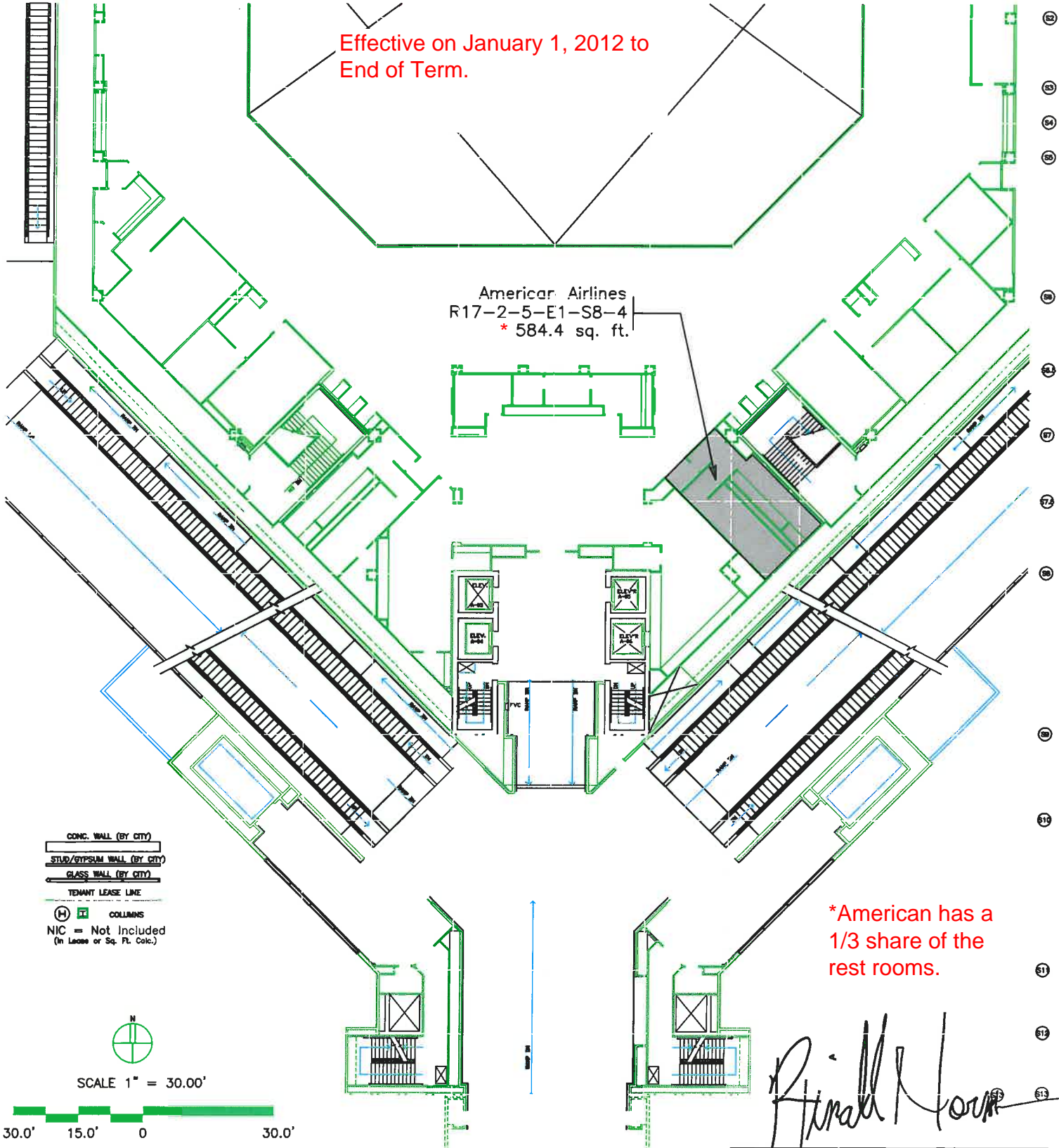
*Ronald Horn*  
MANAGER OF DESIGN



NOTE: This exhibit depicts only square footage of leased area based upon planning data and is not intended to address construction details.

 <p>KEY PLAN CONCOURSE A</p>		REVISED	DENVER INTERNATIONAL AIRPORT	
			EXHIBIT D Concourse A Level 5 American Airlines	
		CC#: amal	DATE: 2/23/10	

Effective January 1, 2012 to  
End of Term

American Airlines  
R17-2-5-W1-S8-4  
\* 577.3 sq. ft.

\*American has a  
1/3 share of the  
rest rooms

- CONC. WALL (BY CITY)
- STUD/GYPSUM WALL (BY CITY)
- GLASS WALL (BY CITY)
- TENANT LEASE LINE
- COLUMNS
- NIC = Not included  
(In Lease or Sq. Ft. Calc.)



SCALE 1" = 30.00'

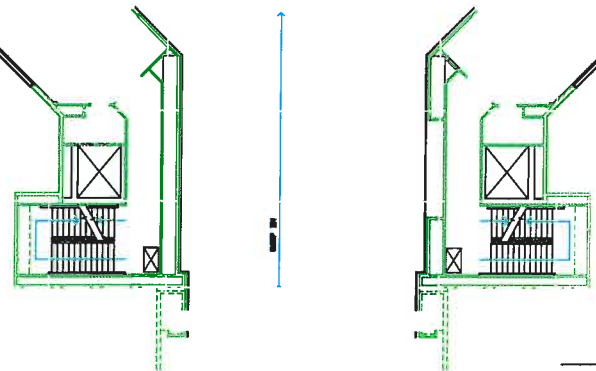

*Arnold Horn*  
MANAGER OF DESIGN

NOTE: This exhibit depicts only square footage of leased area based upon planning data and is not intended to address construction details.

<p>KEY PLAN CONCOURSE A</p>		REVISED	DENVER INTERNATIONAL AIRPORT	
			EXHIBIT D Concourse A Level 5 American Airlines	
		CC#: amal	DATE: 2/23/10	

V7

V6

V7

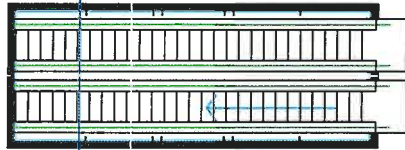
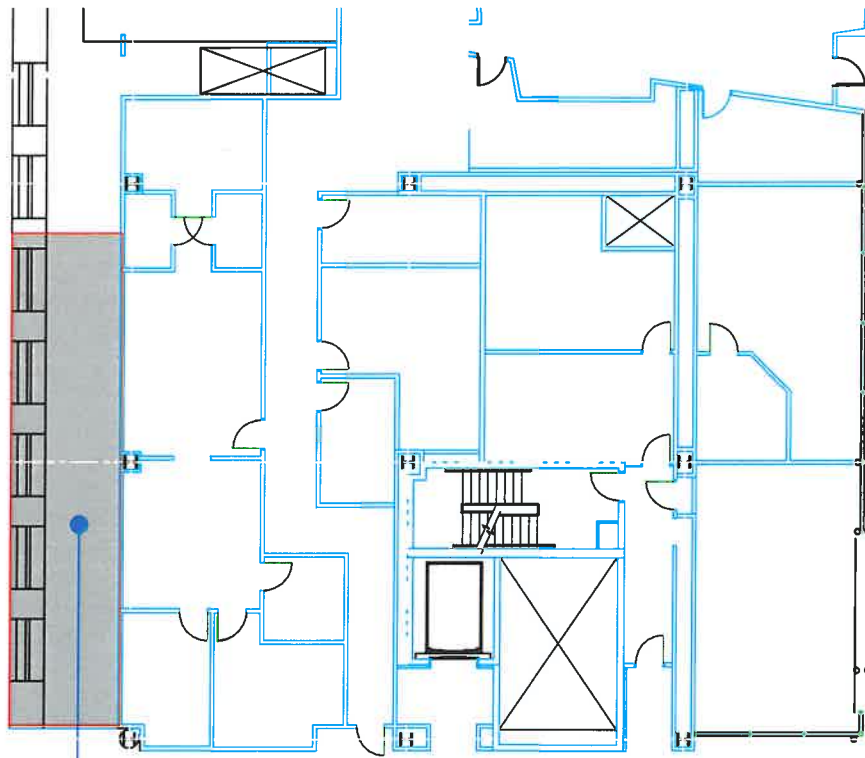

American Airlines  
 R16-1-6-W6-N22-2  
 636.3 sq. ft.

N24

N23

N22

N21

N20

- CONC. WALL (BY CITY)
- STUD/GYPSUM WALL (BY CITY)
- GLASS WALL (BY CITY)
- TENANT LEASE LINE
- (H) (O) COLUMNS
- NIC = Not Included  
(In Lease or Sq. Ft. Calc.)

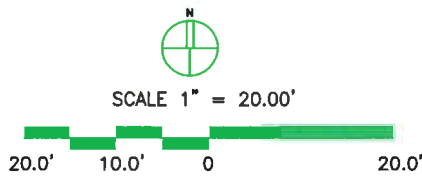

*Ronald Form*  
 MANAGER OF DESIGN

NOTE: This exhibit depicts only square footage of leased area based upon planning data and is not intended to address construction details.

 KEY PLAN TERMINAL AREA		REVISED	DENVER INTERNATIONAL AIRPORT	
		EXHIBIT D Terminal Level 6 American Airlines		
		CC#: AMAL	DATE: 12-13-06	

Effective January 1, 2012 to January 31, 2013 or on date vacated by American, whichever is later.

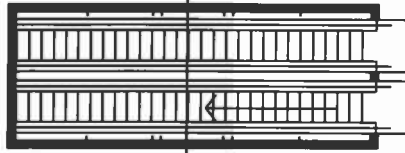
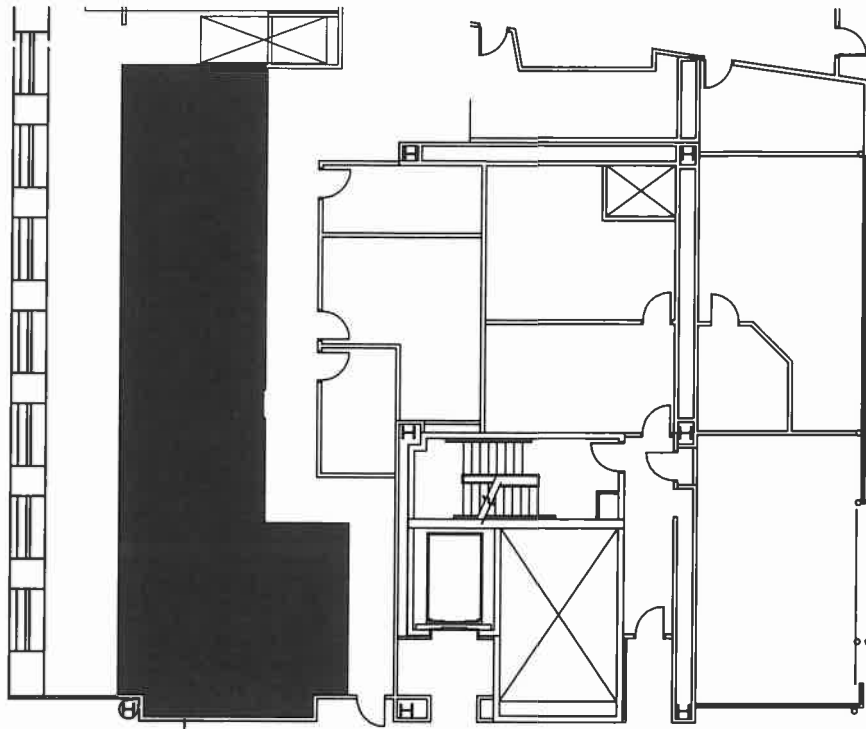

American Airlines  
 R16-1-6-W6-N22-1  
 1245.4 sq. ft.

CONC. WALL (BY CITY)  
 STUD/GYPSUM WALL (BY CITY)  
 GLASS WALL (BY CITY)  
 TENANT LEASE LINE  
 (H) (□) COLUMNS  
 NIC = Not Included  
 (In Lease or Sq. Ft. Calc.)



*Ronald Horn*  
 MANAGER OF DESIGN

NOTE: This exhibit depicts only square footage of leased area based upon planning data and is not intended to address construction details.

	KEY PLAN TERMINAL AREA 		REVISED	DENVER INTERNATIONAL AIRPORT	
				EXHIBIT D Terminal Level 6 American Airlines	
			CC#: AMAL	DATE: 12-13-06	

Effective February 1, 2013 or on date of occupancy, whichever is later, to End of Term.

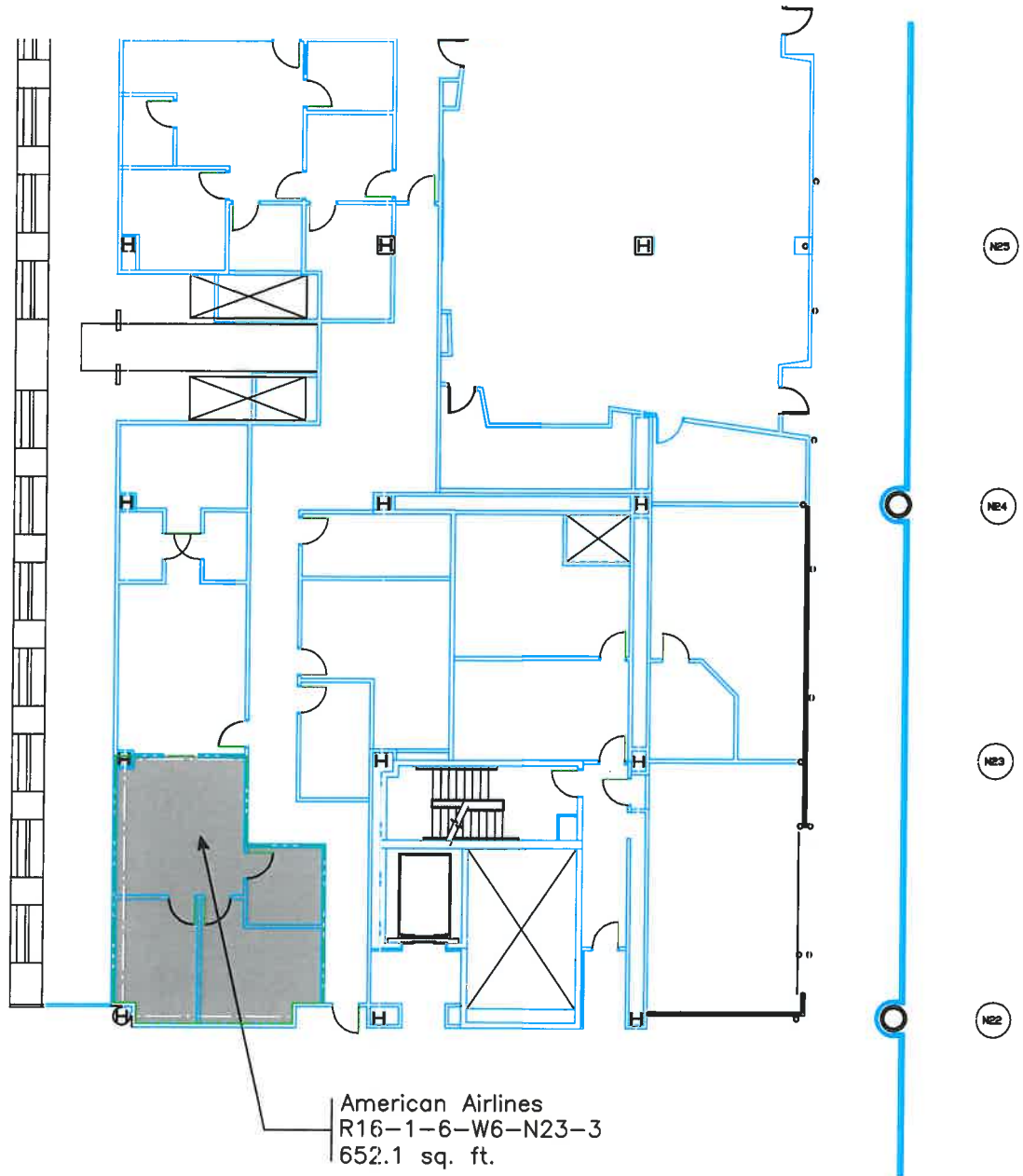

- CONC. WALL (BY CITY)
- STUD/GYPSUM WALL (BY CITY)
- GLASS WALL (BY CITY)
- TENANT LEASE LINE
- Ⓜ □ COLLUMNS
- NIC = Not Included  
(In Lease or Sq. Ft. Calc.)

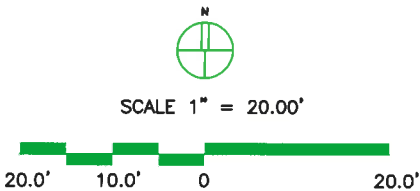

*Ronald Horn*  
MANAGER OF DESIGN

NOTE: This exhibit depicts only square footage of leased area based upon planning data and is not intended to address construction details.

<p>KEY PLAN TERMINAL AREA</p>		REVISED	DENVER INTERNATIONAL AIRPORT
		EXHIBIT D Terminal Level 6 American Airlines	
		CC#: amal	DATE: 10/09/12

Effective January 1, 2012 to January 31, 2013 or on date vacated by American, whichever is later.

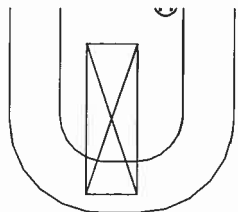

17

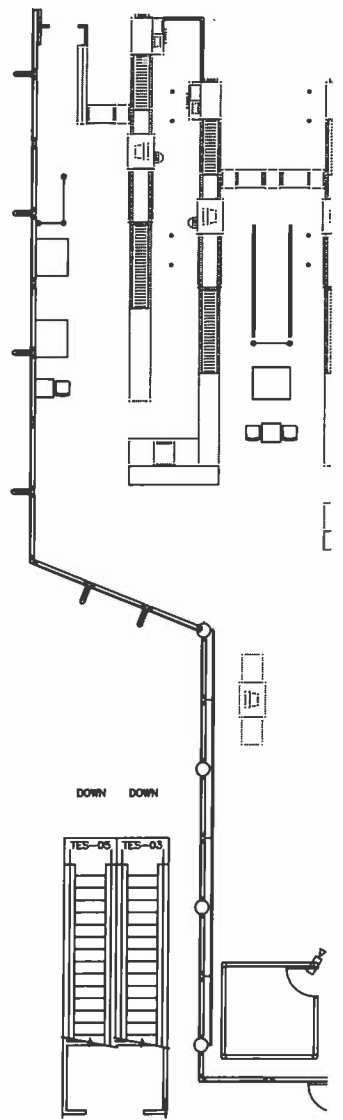
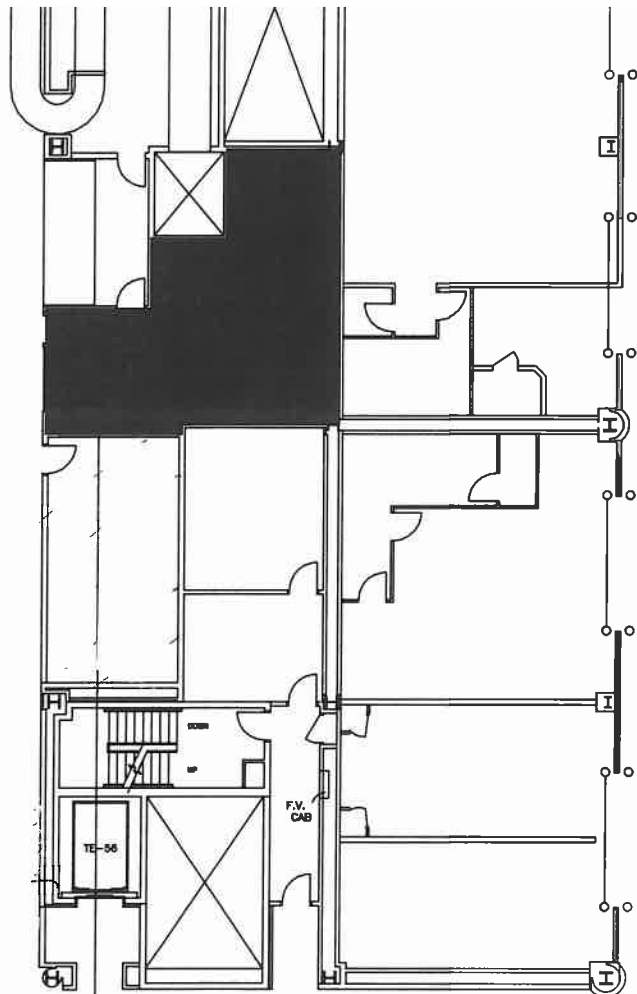
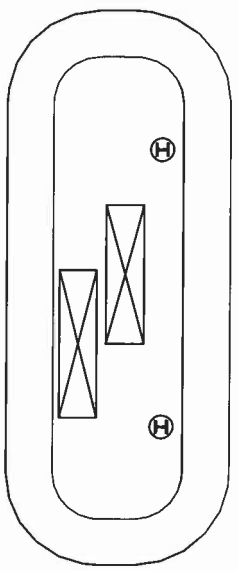

American Airlines  
R16-1-5-W4-N24-2  
687.5 sq. ft.

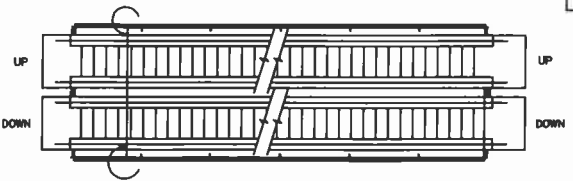

CONC. WALL (BY CITY)  
STUD/GYPSUM WALL (BY CITY)  
GLASS WALL (BY CITY)  
TENANT LEASE LINE  
COLUMNS  
NIC = Not Included  
(In Lease or Sq. Ft. Calc.)

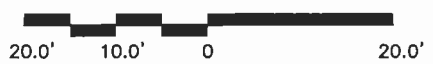

*Ronald Horn*  
MANAGER OF DESIGN

NOTE: This exhibit depicts only square footage of leased area based upon planning data and is not intended to address construction details.

	<p>KEY PLAN TERMINAL AREA</p>		REVISED	DENVER INTERNATIONAL AIRPORT	
				<p>EXHIBIT D Terminal Level 5 American Airlines</p>	
			CC#: AMAL	DATE: 12-13-06	

Effective on February 1, 2013 or on date of occupancy, whichever is later, to End of Term.

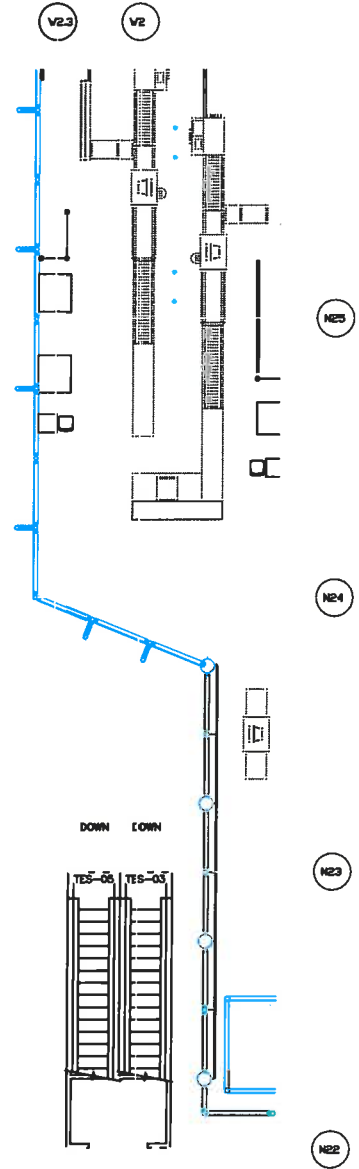
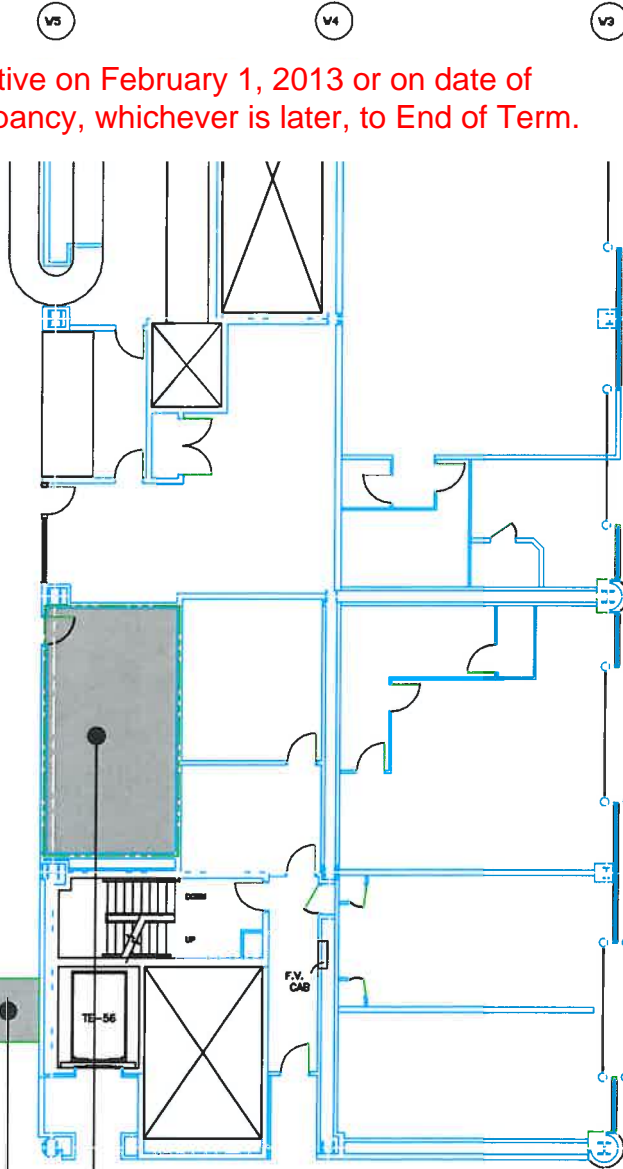
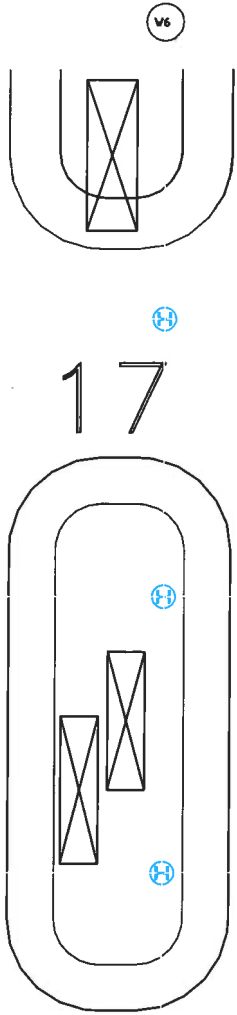

American Airlines  
R16-1-5-W5-N22-1  
42.0 sq. ft.

American Airlines  
R16-1-5-W5-N23-1  
401.3 sq. ft.

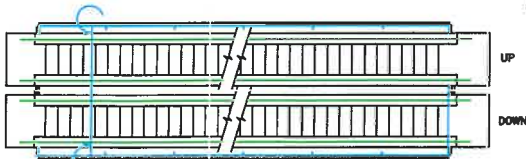

- CONC. WALL (BY CITY)
- STUD/GYPSUM WALL (BY CITY)
- GLASS WALL (BY CITY)
- TENANT LEASE LINE
- (H) (S) COLUMNS
- NIC = Not Included  
(In Lease or Sq. Ft. Calc.)

SCALE 1" = 20.00'



*Ronald Horn*  
MANAGER OF DESIGN

NOTE: This exhibit depicts only square footage of leased area based upon planning data and is not intended to address construction details.

<p>KEY PLAN TERMINAL AREA</p>		REVISED	DENVER INTERNATIONAL AIRPORT
		<p>EXHIBIT D Terminal Level 5 American Airlines</p>	
		CC#: amal	DATE: 08-21-12



E18.6
E19
E20
E21
E21.4
E21.9
E22

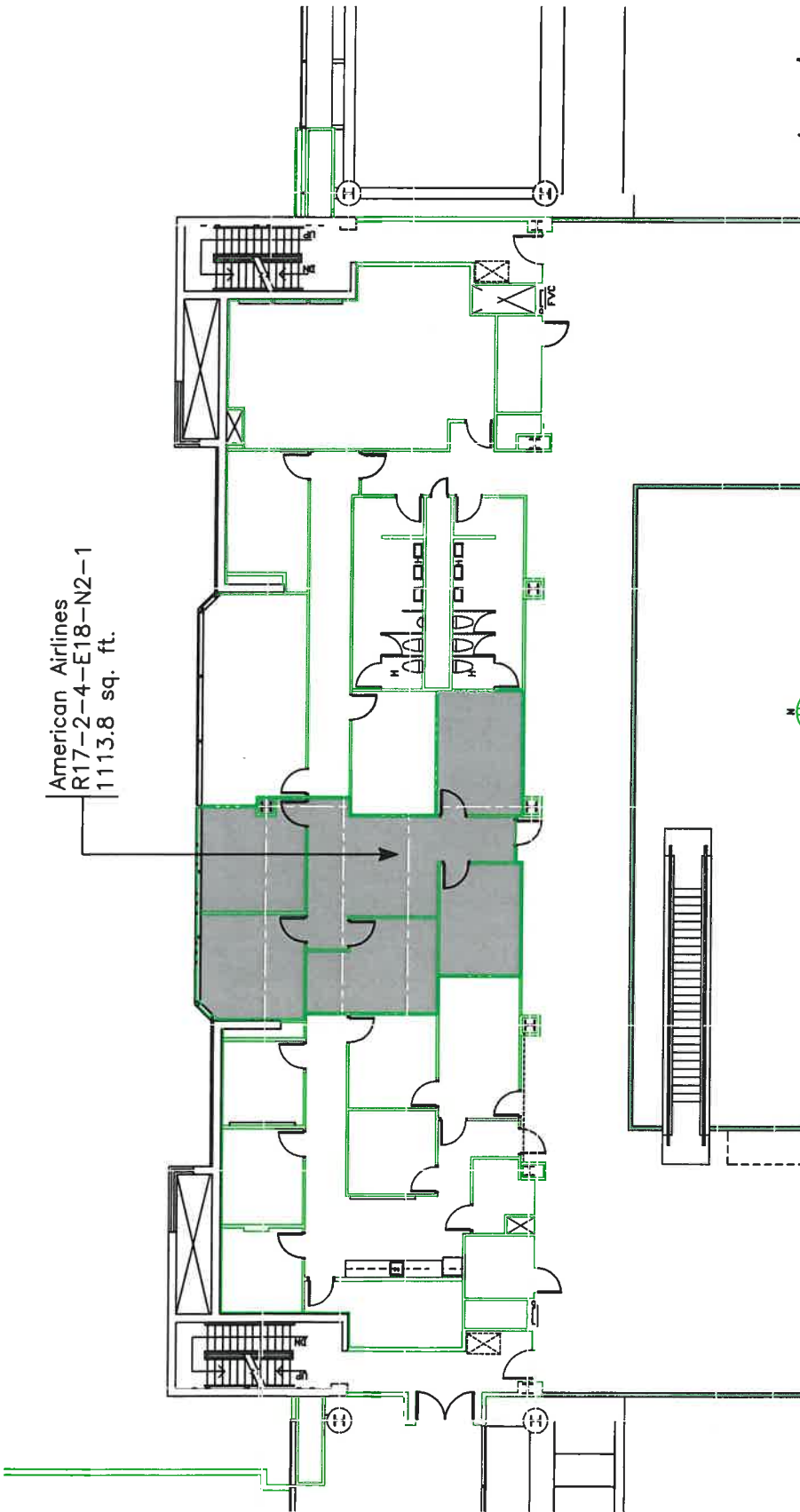

*R. K. Korm*  
 MANAGER OF DESIGN  
 American Airlines

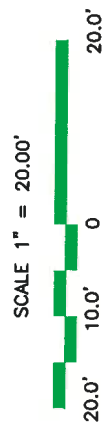

NOTE: This exhibit depicts only square footage of leased area based upon planning data and is not intended to address construction details.

- CONC. WALL (BY CITY)
- STUD/GYPSUM WALL (BY CITY)
- GLASS WALL (BY CITY)
- TEENANT LEASE LINE
- COLUMNS
- NIC = Not Included (In Lease or Sq. Ft. Calc.)



REVISED	DENVER INTERNATIONAL AIRPORT
	
	
KEY PLAN CONCOURSE A	
	
EXHIBIT D Concourse A Mezz. Level American Airlines	
CC#:	amal
DATE:	8/16/12

EXHIBIT E

**DENVER INTERNATIONAL AIRPORT  
SUMMARY OF OPERATION AND MAINTENANCE RESPONSIBILITIES**

	Exclusive Use Premises	Preferential Use Premises	Joint Use Premises	Non-Public Areas	Public Areas	Airfield
Building Exteriors	C	C	C	C	C	C
Building Interior Finishes	A	C	C, A(1,3,6)	C	C	
High Speed Apron Doors	A		C, A (1)	C, A(1)		
Loading Bridges	C, A(9)	C, A(9)				
Landscaping					C	C
Roadways					C	C
Law Enforcement, Fire Protection, Emergency Medical Services	C	C	C	C	C	C
Plumbing	C, A(1 ,2, 10)	C	C, A(1, 2)	C	C	C
Electrical and Lighting	C, A(1 ,3)	C	C, A(1, 3)	C	C	C
Fire Alarm Systems	C	C	C	C	C	
Fire Sprinkler Systems	C	C	C	C	C	
Furnishings	A	C, A (1)	C, A (1)	A	C	
HVAC	C(4), A(1)	C	C	C	C	
Glass Breakage	C, A(1)	C	C	C	C	
FIDS/BIDS/GIDS	C, A(1)	C, A(1)	C, A(1)	C, A(1)	C	
Communications Systems/Paging	C, A(1)	C, A(1)	C, A(1)	C, A(1)	C	
Custodial Service/Window Cleaning	A	C, A(5)	C, A(6, 7)	C	C	
People Movers (elevators, escalators, moving walkways, AGTS)	C, A(1)	C	C	C	C	
Signage	A	C, A(1)	C	C	C	C
Snow Removal	A	A (5)	A	C	C	C
Triturators			C, A (8)			
Baggage Handling Systems	Airline responsibility per separate Agreements (see Section 3.06)					
Bag Claim Carousel Equipment						

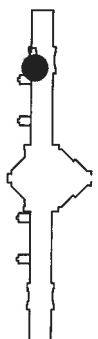
KEY: A = Airline, C = City

1. Airline is responsible for maintenance, repair and replacement of Airline-owned devices and equipment
2. Airline is responsible for routine maintenance, including cleaning drains to the first 25 feet.
3. Airline is responsible for routine maintenance, including relamping. Spent bulbs must be properly disposed of as mandated by law. Light fixtures in BMU areas are Airline's responsibility. City provides electrical power to fixture.
4. City is responsible for building HVAC systems, including airline installed equipment that has been made part of the building system, according to the Tenant Development Guidelines. Airline is responsible for all supplemental equipment, such as computer room cooling units and any other equipment that is not part of the building HVAC system.
5. Airline is responsible for cleaning and snow removal on aircraft parking ramp (from building to outer VSR), including emergency stairs on outside of building and jet bridge stairs.
6. Airline is responsible for cleaning of bag makeup areas on concourses.
7. Airline is responsible for cleaning and providing supplies to joint use restrooms when it is the primary tenant (by number of sq. ft. leased) in the hallway where Joint Use rest rooms are located, unless Airline exclusively leases rest rooms for its employees in this area.
8. Airline is responsible for cleaning after each use.
9. Airline is responsible for replacing damaged PC Air hoses, nozzles and hose handling systems; e.g. reels, baskets, trolleys.

DENVER INTERNATIONAL AIRPORT  
AIRLINE RATE-MAKING METHODOLOGY

General Rate-Making Concepts

The City will use a "compensatory" methodology to establish Terminal Complex rental rates. The Airlines will pay the fully allocated cost of the space that they lease in the Landside Terminal building and airside concourses.

Landing fees will be established according to a "cost center residual cost" methodology, under which the airlines will pay the costs of the Airfield, after first deducting airfield revenues from other sources (primarily general aviation landing fees and fuel flowage fees).

Rate-Making Procedures at the Airport

At the Airport, the City intends to use cost accounting concepts and rate-making procedures as described in the following sections.

Cost Centers Direct (revenue-producing) cost centers include the following:

**Terminal Complex**--All levels of space in the Landside Terminal and airside Concourses A, B, and C, including the pedestrian bridge to Concourse A, public escalators, elevators and moving walkways.

**Commuter and Regional Jet Facilities** – All levels of space in facilities in the Terminal Complex airside Concourses A and C primarily used for commuter and regional jet operations. The Commuter and Regional Jet Facilities cost center excludes the Concourse B Commuter Facility which is allocated to the Concourse B Tenant Finish cost center as outlined in the Stipulated Order dated November

21, 2003. Any additional commuter facilities on Concourse B will be allocated to the Commuter and Regional Jet Facilities. Sub-cost centers will be established for each respective facility. Commuter and Regional Jet ramp areas are assessed separately.

**Airline Tenant Finishes and Equipment**--Airline space finishes and equipment in the Terminal Complex, ticketing facilities, loading bridges, communications equipment, baggage and flight information display systems, and baggage sortation systems which shall include related equipment and space within Concourses A and B (and additional concourses as such sortation systems are operational), and approved modifications to the Automated Baggage system and Space. Sub-cost centers will be established for the Landside Terminal, International Facilities, each airside concourse and each airline as applicable.

**Interline Bag Transfer Area** – All space in the Landside Terminal used by airlines for interline baggage transfer operations.

**Common Use Terminal Equipment** All costs associated with the installation and maintenance of the City's common use terminal equipment. The airline is responsible for its proprietary equipment.

**Concourse Joint Use Facilities**--All space and related equipment in Concourses A, B, and C for tug space (parking, drives, and circulation) and common use facilities, (including, but not limited to, pre-conditioned air facilities, triturators, etc.). The apron level on Concourse C shall be included in the Concourse C tug circulation space (excluding the space occupied by the baggage carousels on the Concourse C Apron).

**Baggage Claim**--All baggage claim space and equipment in the Landside Terminal including carousels, input conveyors and related inbound baggage handling space in the Landside Terminal.

**Automated Baggage System and Space**--The inbound and outbound automated DCV baggage systems (AABS and UABS), including their equipment and related space (excluding the Tunnel space allocated to the AGTS and Tunnel cost center) in the Landside Terminal and in the Tunnel from the Landside Terminal to the Concourses, separately serving Concourse A (the "AABS") and separately serving Concourse B (the "UABS"), including the costs of the maintenance space, control room equipment and related control room space, (excluding the costs of baggage sortation system equipment and space in the concourses and the costs of approved modifications to the automated systems which are included in the baggage sortation for each concourse).

**Conventional Baggage System**--The outbound conveyor baggage system and equipment, including all costs of baggage equipment, and construction costs to accommodate the Conventional Baggage System and related operations, Landside Terminal tug spaces (parking, drives and circulation), porter warming shelters, and odd size lift space in the Landside Terminal, Baggage Sortation space in the Landside Terminal, related maintenance space and the Baggage Sortation Space in the parking structure used for the Conventional Baggage System.

**AGTS and Tunnels**--The Automatic Guideway Transit System ("AGTS"), including vehicles and equipment, the AGTS tunnels and the baggage and tug tunnels between the Landside Terminal and the airside concourses and tunnel modifications for tug and cart operations.

**International Facilities**--International gates on Concourse A and related holdrooms, sterile circulation space, ramp areas, operations space, international

baggage recheck belt space and equipment, and the FIS area in the Landside Terminal, and the international portion of the connector to Concourse A.

**Concourse Ramp Area**--The aircraft parking aprons and pushback zones located adjacent to the airside concourses.

**Airfield Area**--The runway and taxiway system, deicing and related facilities, undeveloped acreage, and 50% of the costs incurred to develop the North Cargo Site prior to February 28, 1995.

**Public Parking Area**--All space allocated for public parking in the parking structure and all other public parking lots (excluding the cost of the parking structure space allocated to the Conventional Baggage System in the Conventional Baggage System cost center in the event the average number of cars in the Parking Structure exceeds 12,000 for 22 consecutive days).

**Employee Parking Area**--The employee parking lot(s).

**Fueling System**--The fuel storage and distribution system, including hydrant fueling pits at the aircraft parking aprons.

**Commercial Vehicle Facilities**--The surface parking area and building to be used for staging commercial vehicles and the dedicated commercial roadways serving the Terminal Complex. Commercial vehicles include but not limited to hotel/motel courtesy vans, taxis and limousines.

**Rental Car Facilities**--Areas and roadways provided for rental car operations (excluding the Terminal Complex).

**Cargo Area**--The joint use air cargo facilities (including apron, building, ground service equipment, and truck parking areas) and other areas provided for air cargo carriers and freight forwarders. Sub-cost centers will be established for cargo building, cargo apron, cargo tenant finishes, and cargo ground service equipment areas.

**Airline Maintenance and Support Area**--Areas provided for airline maintenance facilities, cargo facilities, ground service equipment facilities and inflight kitchens.

**Airport Mail Facility**--Areas provided for the Airport mail facility.

**Future Concourses**--Costs related to all levels of space and associated apron areas of any airside concourses in addition to Concourses A, B, and C shall be allocated to new cost centers to be established.

**Future Baggage Systems** – Costs related to all levels of space and equipment for future baggage systems.

Indirect (nonrevenue-producing) cost centers are to include, but not limited to:

**Access, Terminal, and Service Roadways**--Peña Boulevard, other secondary access roads, the terminal area roadways, the terminal curbsides, the perimeter circulation roadway, and other secondary internal roadways.

**Airport Maintenance**--Airport maintenance facilities and indirect (unallocated) maintenance expenses.

**Airport Administration**--Airport administrative facilities and administrative expenses.

**Aircraft Rescue and Fire Fighting (ARFF)**--The rapid response stations, structural fire station(s) and ARFF operating expenses.

Certain Cost Center Allocations

The net requirement of the Terminal Complex will be recovered through rental rates. Net Terminal Complex requirements will be divided by total Rentable Space in the Terminal Complex to determine the average rental rate per square foot of rentable space. For purposes of calculating the average Terminal Complex rental rate, Rentable Space shall be the sum of (a) 65% of approximately 99,000 square feet of Concourse B Basement Space on Concourse B, and (b) 100% of all other airline and nonairline Rentable Space in the Terminal Complex. Concourse B Basement Space shall be defined as exclusive use space on Concourse B located in the basement below the apron level. Concourse B Basement Space shall not include Baggage Sortation Space, Automated Baggage System Space, or Concourse Joint Use Facility space. The rental rate per square foot charged for 99,000 square feet of Basement Space on Concourse B will be equal to 65% of the average Terminal Complex rental rate. The rental rate for all other airline space shall be equal to 100% of the average Terminal Complex rental rate. Space costs associated with baggage claim, Automated Baggage System and Space, International Facilities, and baggage sortation space on Concourse B shall be determined using the average Terminal Complex rental rate.

The net requirement of Commuter and Regional Jet Facilities shall be computed independently for each airside concourse. The requirement of each concourse Commuter and Regional Jet Facilities shall include all allocated Airport Costs. The requirement of each concourse Commuter and Regional Jet Facilities will be recovered through separate fees assessed based on the City's estimate of full utilization of the respective facility and allocated based on landed weight.

.



Charges for the Interline Bag Transfer Area will be assessed among airlines based on their respective linear feet of baggage shelving area in the Interline Baggage Transfer Area as a percent of total linear baggage shelving area.

The requirement for the Common Use Terminal Equipment (CUTE) will be recovered through a fee assessed to airlines utilizing the system. The CUTE fee will be assessed based on the City's estimate of full utilization of the equipment and allocated based on landed weight.

The net requirement of the Concourse Ramp Area will be recovered through separate ramp fees assessed on a per-lineal-foot basis measured two hundred and fifty (250) feet from the exterior walls of each concourse. Commuter and regional aircraft ramp fees will be calculated based on a 50% of the sum of the per-lineal-foot measurement of the respective ramp area.

The net requirement of the Airfield Area will be recovered through landing fees assessed on the basis of the total landed weight of all aircraft using the Airport.

International fees will be assessed as follows to recover costs allocable to the International Facilities cost center. A fee will be assessed per deplaned international passenger for the FIS area and a separate fee will be assessed per enplaned and deplaned passenger for the gate-use fee. The City will record the shortfall of revenues each year as a payment-in-aid and will keep a cumulative account of this shortfall. If revenues exceed expenses in any given year the cumulative payment-in-aid will be reduced.

Fueling system charges will be distributed 10% equally and 90% on a gallonage basis among airlines to recover all of the costs associated with the fueling system.

Charges for the AGTS and Tunnels will be assessed among airlines on the basis of their respective (a) originating and destination passengers at the Airport for domestic flights

and (b) originating passengers at the Airport for international flights for the preceding three-month period.

Baggage Claim space will be costed at the average rental rate in the Terminal Complex. This amount will be added to the Baggage Claim cost center costs. Charges for the Baggage Claim cost center will be allocated among airlines on the basis of their respective deplaned domestic destination passengers for the preceding three-month period until outbound bag tracking information is available when charges will be allocated based upon the respective number of outbound bags including odd-size bags.

Landside Terminal space allocated to the Conventional Baggage System will be costed at the average rental rate of the Terminal Complex. The cost of this space shall be allocated to airlines based on Airline rented square footage in the Landside Terminal. Space in the Public Parking Area will be costed at the average cost per square foot of the Parking Structure, and, when applicable, will be added to the Conventional Baggage System cost center. Charges for the Conventional Baggage System cost center, including equipment, construction costs and related Baggage Sortation Space in the Landside Terminal, and related Public Parking Area space will be allocated to a sub-cost center for each of the modules presently developed in the Landside Terminal and Parking Structure (additional modules will be added when developed). The costs of each module shall be charged to the airline(s) leasing or using those facilities. In the event the Conventional Baggage System equipment and/or space is jointly used by two or more airlines, such costs will be allocated among such airlines on the basis of their proportional number of carousels in the module exclusively used by each airline to the total number of carousels in their module. Furthermore, if a carousel is jointly used by two or more airlines, the costs allocated to such carousel will be further allocated to each carrier using the carousel based on their proportional share of originating passengers.

The cost of the Parking Structure and Baggage Sortation Space in the Landside Terminal will be allocated to each module based on the square footage of that module used for the

Conventional Baggage System. However, the airlines will not be charged for such costs until the average number of cars in the Parking Structure exceeds 12,000 for 22 consecutive days.

The cost of Concourse Joint Use Facilities shall be determined on the basis of the average Terminal Complex rate. The cost of the Joint Use Facilities in each concourse shall be separately allocated based on Airline rentable square footage within the respective concourse and charged to the respective airlines using the facilities in each concourse based on their proportional share of rented square footage to the total airline rentable square footage. Airline rentable space used to allocate the cost of Concourse Joint Use Facilities on Concourse C shall include approximately 83,855 square feet of undeveloped space on that concourse. If the approximately 83,855 square feet of undeveloped space on Concourse C, or any portion thereof, is leased by an airline, the leased portion shall be reclassified as airline rentable and the remainder of the approximately 83,855 square feet shall remain a part of the airline rentable space used to allocate the cost of Concourse Joint Use Facilities on Concourse C.

The space associated with the Automated Baggage System and Space in the Terminal Complex will be costed at the average rental rate of the Terminal Complex. This amount will be added to the equipment costs of the Automated Baggage System and Space and allocated 65% to UABS serving Concourse B and 35% to AABS serving Concourse A and assessed among the airlines on each respective concourse on the basis of their respective originating and destination passengers on each concourse for the preceding three-month period. Debt service on Bonds issued to construct the Airport originally, amortization charges, and variable rate bond fees included in the 35% of costs allocable to the AABS shall be reduced by PFC revenues, which shall be allocated to the AABS. The PFC revenue allocated to the AABS will be adjusted from time to time by the City and the City will use its best efforts to achieve a 12% premium in the weighted average effective rate per square foot on Concourse A in comparison to the weighted average effective rate on Concourse C. The methodology to calculate the weighted average

effective rate per square foot on each concourse is described below. The amount of PFC revenue allocated to the AABS shall not exceed the portion of the Automated Baggage System and Space that is eligible to be funded with PFC revenues under the Record of Decision. The Record of Decision states that Baggage Systems are 47.22% eligible.

The weighted average effective rate per square foot for each concourse shall be equal to the sum of: (a) the average Terminal Complex rental rate, (b) the average tenant finish and equipment rate per square foot applicable to each concourse, (c) the cost of Concourse Joint Use Facilities divided by airline rentable space on each concourse, (d) baggage sortation equipment charges divided by total airline rented space on each concourse, and (e) Automated Baggage System and Space charges divided by total airline rented space on each concourse. For purposes of calculating the weighted average effective rate per square foot, Concourse A total airline rented space shall be 91,760 square feet.

Airline Tenant Finish and Equipment costs, excluding the costs of the baggage sortation equipment and approved modifications to the Automated Baggage System and Space to provide for the automated system on Concourses A and B, shall be allocated to the applicable sub-costs centers and then divided by total airline rentable space in that cost center to determine the average tenant finish rate per square foot. The cost of Baggage Sortation Space located on concourses shall be determined using the average Terminal Complex rental rate and allocated based on airline rentable space located on each respective concourse.

The costs of the Concourse A baggage sortation system equipment and approved modifications, so long as such equipment is not being leased or utilized, shall be allocated exclusively to the airlines operating on Concourse A on the basis of their respective passenger enplanements on Concourse A. One-half of Concourse A baggage sortation equipment is located on the east side of Concourse A and one-half of said equipment is located on the west side of Concourse A.

If an airline or airlines lease or utilize all of the baggage sortation system equipment on Concourse A, or a portion of said equipment on both the east and west sides of Concourse A, the costs of such equipment shall be allocated exclusively to such airline or airlines leasing or utilizing all the equipment on the basis of their respective Concourse A passenger enplanements. To the extent all of the Concourse A baggage sortation equipment is leased or utilized by an airline or airlines, all other airlines operating on Concourse A will not be responsible for costs associated with the Concourse A baggage sortation equipment.

If an airline or airlines lease or utilize all or any portion of the Concourse A baggage sortation system equipment at only one of the two locations, 50% of the cost of the Concourse A baggage sortation system equipment shall be allocated exclusively to such airline or airlines on the basis of their respective passenger enplanements on Concourse A. Costs of the Concourse A baggage sortation system equipment not being leased or utilized by an airline or airlines shall continue to be allocated to all airlines operating on Concourse A on the basis of their respective passenger enplanements on Concourse A.

The costs of the Concourse B baggage sortation system equipment and approved modifications shall be allocated exclusively to the airlines operating on Concourse B on the basis of their respective passenger enplanements on Concourse B. The costs of the Concourse C baggage sortation system equipment as of February 28, 1995 shall be allocated to the Concourse B sortation system equipment until such equipment is otherwise utilized or leased by other airlines.

In the event an automated baggage system is constructed for Concourse C or for any additional airside concourse, the costs related to such baggage system(s), equipment and space shall be allocated to Concourse C, or the new concourse as applicable, and charged exclusively to the airlines operating on such concourse.

In the event a Future Baggage System is constructed for any concourse or concourses, the costs related to such baggage system(s), equipment and space shall be charged to the airlines operating on such concourse(s) as the City and airlines may reasonably allocate. Costs associated with the planning and design, excluding construction documents, for the Future Baggage System will be allocated to the Terminal Complex Cost Center.

Costs associated with undeveloped acreage will be allocated to the Airfield Area until the land is developed. Costs and revenues associated with developed acreage will be allocated to the applicable cost center.

Not more than forty percent (40%) of the costs (debt service and operating and maintenance expenses) associated with the Access and Terminal Roadways shall be allocated to the Terminal Complex.

Costs associated with the Service Roadways shall be allocated back to the direct cost centers based primarily on which cost centers benefit from such Service Roadways.

Not more than eighty percent (80%) of the costs associated with Aircraft Rescue and Fire Fighting shall be allocated to the Airfield Area cost center.

Costs associated with the Airport Administration cost center will be allocated based on a 50/50 revenue/direct expense formula: fifty percent (50%) on the percentage distribution of operating revenue by cost center and the remaining fifty percent (50%) allocated on the percentage distribution of direct Operation and Maintenance Expenses by cost center.

Undeveloped space shall include space in which no buildout has occurred.

Rentable Space shall mean space leased pursuant to an agreement or on a per use basis, or typically available for lease in the Terminal Complex except for: (i) mechanical and electrical space, (ii) public spaces including restrooms, circulation spaces, stairwells,

stairways, escalators, elevators, public lounges and public queuing space, (iii) Undeveloped Space, (iv) approximately 83,855 square feet of space in the basement of Concourse C until such space is leased or utilized, (v) the space in level 3 of the Landside Terminal interior to the tug circulation rights-of-way not otherwise leased or used, (vi) approximately 108,000 square feet of baggage sortation space on Concourse A, (vii) baggage sortation space in the Landside Terminal, unless the average number of cars in the parking structure exceeds 12,000 for 22 consecutive days, (viii) approximately 105,100 square feet of Concourse B baggage sortation space, (ix) space in the Administration Office Building and (x) space for security checkpoint areas and areas for explosive detection systems and explosive trace detection. The City shall determine what constitutes the various types of space and associated square footage in this paragraph and shall have the right, from time to time, to revise the categories of space and the square footage of each category.

If the 108,000 square feet of former baggage sortation Concourse A space is leased, the space will not be included in the calculation of airline rates and charges and, specifically, the calculation of the average Terminal Complex rental rate. The annual rental rate per square foot charged for Concourse A baggage sortation space shall be equal to 50% of the average Terminal Complex rental rate in that year.

Baggage Sortation Space includes all areas where out-bound baggage is sorted for delivery to departing aircraft.

#### Airport Costs

Airport Costs (also referred to as "requirements") include without limitation:

- (1) Operation and Maintenance Expenses.
- (2) Deposits to the Operation and Maintenance Reserve Account of the General Bond Ordinance

- (3) Debt service including variable rate bond fees on Bonds issued for Airport and any other amounts required under the General Bond Ordinance except debt service paid by PFC revenues.
- (4) Debt service including variable rate bond fees on Bonds used for Airport land acquisition.
- (5) Equipment and capital outlays
- (6) Amortization of 50% of the City's Airport expenditures incurred prior to January 1, 1990, from Capital Fund and Operating Fund moneys used for (a) pre-1990 planning and administrative costs, (b) Airport land acquisition, (c) Airport project costs, and (d) debt service including variable bond fees, on Bonds used for Airport land acquisition.
- (7) Amortization of all investments made for the New Airport project from other than Bonds or grants after January 1, 1990 and prior to February 28, 1995.
- (8) Amortization of the City's investment in the Airport Coverage Account to be accumulated prior to February 28, 1995.
- (9) For the purposes of items (6), (7), and (8) above, amortization charges are to be calculated over 15 years at the weighted average effective interest cost on all Airport fixed-rate Bonds as originally issued prior to January 1, 1997. Except and only to the extent, if any, that the rights of the owners of its airport revenue bonds (including, without limitation, the rights arising from the rate maintenance covenant) are not thereby materially impaired, the City will cause, by January 1, 1997 (or as soon thereafter as possible consistent with the City's aforesaid obligations to owners of its airport revenue bonds), amortization of the net



- unamortized balance of City's investments in items (6), (7) and (8) above on a straight-line basis for the balance of the period through March 1, 2025.
- (10) Amortization of reimbursements made to United Airlines related to costs for modifications to the United Airlines automated DCV baggage system, not to exceed \$45 million, from other than bonds shall be calculated on a straight line basis over 30 years, effective as of the date of any such reimbursement, at the weighted average effective interest rate of all Airport fixed-rate bonds prior to January 1, 1997.
  - (11) Amortization of the City's investments from the Capital Fund, subsequent to February 28, 1995, shall be amortized at the average rate of the Airport fixed-rate bonds over 15 years or the life of the asset, whichever is shorter, and charged to the Airlines.
  - (12) All airline bad debt will be allocated to the airfield cost center.

#### PFC Revenues

PFC Revenues will not be treated as Gross Revenues for the purpose of establishing airline rates, fees and charges. For rate-making purposes, PFC revenues shall be allocated to the extent available, to at least fifty percent (50%) of the capital costs and/or debt service associated with the following eligible projects in the following order of priority: (1) facilities for the Federal Inspection Services, (2) the portion of Pena Boulevard from an interchange with E-470 to the Terminal Complex and terminal area roads, (3) the AGTS and Tunnels. That portion of the capital costs or debt service paid for by PFC revenues will not be included in the calculation of the airline rate base.

Airport "Credits"

**Interest income** - Interest income on the Bond Reserve Fund (provided that the minimum Bond Reserve Requirement has been funded) and on the Interest and Principal Accounts of the Bond Fund that are Gross Revenues shall be credited to the cost centers of the Airport in the same proportion as the debt service allocation.

**Other credits** - To the extent the City receives revenues for the use and lease of all, or any part, of the 108,000 square feet of undeveloped Concourse A baggage sortation space, such revenues will be allocated to the cost centers of the Airport in the same proportion as debt service on Bonds issued for the Original Airport Project.

**Airline Revenue Credit** - The City shall establish accounts within the Capital Fund as illustrated in Figure 1. Net Revenues of the Airport System, as defined in the General Bond Ordinance, flowing to the Capital Fund each year are to be used to replenish reserve funds or accounts as required in the General Bond Ordinance and the Coverage Account and to fund the Equipment and Capital Outlay Account for equipment and capital outlays included in the operating budget. Remaining Net Revenues are to be allocated as follows: (a) 75% from March 1, 2000 through February 28, 2006 and 50% thereafter, up to a maximum of \$40 million to flow into the Airline Revenue Credit Account to be applied as a credit against Signatory Airlines rates and charges in the following fiscal years and (b) the balance to flow into the Capital Improvement Account.

The City shall maintain a Coverage Account and fund that account up to an amount equal to twenty-five percent (25%) of Debt Service Requirements on Bonds issued to finance the Airport, improvements at the Airport and land acquired for the Airport. Bonds shall not include Special Facilities Bonds and other Bonds to finance support facilities such as cargo, maintenance and food preparation facilities). The Coverage Account shall be considered as Other Available Funds (as defined in the General Bond Ordinance) for the purpose of meeting the Rate Maintenance Covenant of the General Bond Ordinance.

**Reduction of airline rates and charges**

The City will reduce all airline rates and charges by \$4 million per year from 2004 through 2010. The sources available to the City for the rates and charges cost reductions include, but are not limited to: \$1.50 PFC revenues, the City's share of revenue credit, and annual debt service interest savings from refunding outstanding airport revenue bonds.

The rates and charges cost reductions outlined above shall cease if (i) there is an insufficient annual deposit to the Capital Improvement Account to make the annual \$1.5 million payment to Stapleton Development Corporation, (ii) the City is unable to meet its annual irrevocable commitment to pay debt with PFC revenues under the Bond Ordinance, or (iii) regulatory or other legal action precludes payment of these rates and charges cost reductions (cost reductions will be deferred during the pendency of any such actions, and reinstated and extended as necessary upon a successful conclusion to such action to ensure that all airlines receive the full benefit of these reductions).

The City's rates and charges cost reduction contribution shall be reduced if Airport management (i) determines in good faith that there is a deficiency in any of the required Airport fund balances, (ii) receives an official written communication from any rating agency that a downgrade of the Airport's existing credit rating is likely unless a reduction to the City's rates and charges cost reduction contribution is made, or (iii) determines in good faith that operating cash balances are insufficient and contributions would jeopardize the ongoing operation of the airport.

Miscellaneous

All defined terms used herein shall be consistent and subordinate to the defined terms in the General Bond Ordinance.

Concourse A Baggage Sortation Space

The City redeemed Airport project Bonds equal to the principal outstanding associated with approximately 108,000 square feet of Concourse A baggage sortation space.

Debt service costs associated with Bonds issued by the City to redeem the Bonds associated with the 108,000 square feet of Concourse A baggage sortation space shall be allocated to the cost centers of the Airport in the same proportion as debt service on Bonds issued for the Original Airport Project.

## EXHIBIT G

### Design Standards, Construction Procedures and Environmental Requirements

**Section 1. Design Standards.** The Airline agrees to utilize and comply with the Denver International Airport Design Standards Manuals for design of the Facilities. The Airline further agrees to design, construct, and operate the Facilities in accordance with the Denver International Airport Tenant Development Guidelines and the Denver International Airport Rules and Regulations, as they may be established or amended from time to time, and any other applicable design, construction, operation, and maintenance standards. See additional information at <http://business.flydenver.com/bizops/bizRequirements.asp>

All civil design drawings submitted by the Airline to the City shall be provided and submitted according to FAA requirements in Advisory Circular AC150/5300-18B GIS Standards: Collection of airport data through field and post processing methodologies are specified in this FAA Advisory Circular. The data model specifies the following Geographical Information System (GIS) feature groups: Airfield, Airspace, Cadastral, Environmental, Geospatial, Man Made Structures, Navigational Aids, Seaplane, Security, Surface Transportation, and Utilities. The model incorporates safety critical data including runway thresholds, navigational aids as well as other airport features including runways, taxiways, aprons, buildings, roadways, cadastral, land-uses, and utilities. The single GIS airport database will serve numerous needs and therefore requires a very robust set of data features and associated attributes. As a result, significant time and effort is required to collect and input the metadata (data about data). The power of an airport GIS database is derived from the metadata. The long term application of airport GIS data collection methodology will reduce survey costs, errors, and missing data.

To facilitate these FAA requirements GIS/CADD data submittals shall adhere to the data standards set forth in DIA Design Standards Manual 12 (DSM 12). CADD/GIS files must be submitted that are compatible with the FAA's AGIS database and includes all features required by the FAA relevant to the project. Each feature shall be fully and accurately attributed according to the specifications of FAA AC 150/5300-18B. Any files rejected by the FAA must be corrected and resubmitted to DIA's Project Manager until satisfactorily accepted by the FAA. Final CADD survey data required for FAA submission should adhere to the standards provided in DSM 12.

Approval of the City shall extend to and include consideration of architectural and aesthetic matters and the City reserves the right to reject any designs submitted and to require the Airline to resubmit designs and layout proposals until they meet with the City's approval.

In the event of disapproval by the City of any portion of the plans and specifications, the Airline shall promptly submit necessary modifications and revisions thereof.

**Section 2. Construction Procedures.** All construction work shall comply with the requirements of and standards established by the City and all other appropriate governmental agencies and entities.

The City shall at all times have the right to monitor and inspect the construction of the Facilities and all site improvements to assure that the Facilities and all site improvements are constructed and installed in compliance with the Plans and Specifications.

In order to assist the City in monitoring and inspecting such construction, the Airline's contractor or contractors shall submit, or cause to be submitted to the City, for information and record purposes, copies of all (i) permit applications, permits and plans required by permits, (ii) field test reports, (iii) material certificates, (iv) approved shop drawings to be reviewed for compliance with the Airport design and construction standards, (v) requests for payment to contractors or subcontractors, (vi) progress reports, (vii) notification of substantial completion of the leased facilities and all site improvements and final acceptance thereof, (viii) two copies of maintenance and operation manuals in connection with building systems and all updates thereof, (ix) as-constructed drawings, and (x) any other documents related to the construction of the Facilities which may be reasonably requested by the City.

No change order which materially changes the scope of the work shall be effected by the Airline without the approval of the Manager, which approval shall not be unreasonably withheld. The City will approve, conditionally approve or disapprove submissions of change orders within a reasonable period of time following receipt thereof. Any conditional approval or disapproval shall be accompanied by an explanation as to the reason therefore.

All construction work, materials, and installations involved in or incidental to the construction of the Facilities and all other improvements on Airport Property undertaken by the Airline throughout the term hereof shall be subject at all times to inspection and approval by the City.

The Airline shall give or cause to be given to the Manager advance notice before performing any modification to Airport Property.

The Airline shall cause all construction work, workmanship, materials, and installations to be in full compliance with plans and specifications. The City shall have the right to halt construction of the Facilities or any site improvement at any time if such construction is at material variance from the Plans and Specifications until such variance is corrected, or if such construction poses an immediate safety hazard at the Airport, until such safety hazard is eliminated. The City shall cooperate and use its best efforts to alleviate and resolve any such variance or impediment to the safe operation of the Airport so as to permit continuation of construction as expeditiously as possible.

The Airline, at its sole cost and expense, shall make and obtain such utility connections, hook-ups or taps as shall be necessary and shall have the right to receive all necessary utilities and services and shall secure all necessary applications and permits and shall pay all application and permit fees, hook-up or tap fees and all other user charges of whatever nature occasioned thereby. The Airline further agrees at its sole cost and expense to provide meters adequate to measure the amount of utilities and water used or consumed and to maintain said equipment in such a manner as to supply accurate measurement of such usage and consumption.

The Airline shall also include in its agreements with its general contractors covenants that require the construction contractor and its subcontractors of any tier to pay all workers, mechanics, and laborers in accordance with the rates and classifications established under the federal Davis-Bacon Act and Section 20-76 or the Denver Revised Municipal Code, whichever is greater. The Airline further agrees, if requested by the Manager, to fully comply with the procedural requirements of Section 20-76 of the Denver Revised Municipal Code by requiring its general contractors and their subcontractors of any and all tiers to submit to the City true and correct copies of the payroll records of all workers, laborers and mechanics employed.

The Airline throughout the term of this Agreement shall not without the prior written approval of the Manager make any material or structural alterations, improvements or additions to Airport Property, including without limitation any interior modifications or improvements.

Any work necessary to make any alterations, improvements or additions to the premises throughout the term of this Agreement shall be done at the Airline's sole cost and expense and in accordance with and subject to all of the required approvals, submittals and procedures, and all other requirements of whatsoever nature, set forth herein in reference to the initial construction by the Airline of the Facilities and its related site improvements.

Upon completion of such work, the Airline shall deliver to the City revised as-constructed drawings, and evidence of payment, contractor's affidavits, and full and final waivers of any liens for labor, services, or materials. The Airline shall include in the Airline's agreement with its contractors provisions whereby such contractors shall defend and hold the City harmless from all costs, damages, liens, and expenses related to such work.

All work done by the Airline or its contractors shall be done in a first-class workmanlike manner using only good grades of materials and shall comply with all insurance requirements and all applicable laws and ordinances and rules and regulations of governmental departments or agencies. Whenever a conflict arises between state or local law, ordinances or regulations, and federal law or regulations, Federal law or regulations applicable to this agreement shall control.

Within 60 days after completion of construction of the Facilities, the Airline shall furnish to the Manager two sets of as-constructed drawings, showing in detail all construction, including the locations of all underground and above ground utility lines.

All civil as-constructed drawings shall be provided by the Airline to the City in accordance with the City's design standards, and shall be submitted to: AC150/5300-18B GIS Standards and shall adhere to the data standards set forth in DIA Design Standards Manual 12 (DSM 12). CADD/GIS files must be submitted that are compatible with the FAA's AGIS database and include all features required by the FAA relevant to the project. Each feature shall be fully and accurately attributed according to the specifications of FAA AC 150/5300-18B. Any files rejected by the FAA must be corrected and resubmitted to DIA's Project Manager until satisfactorily accepted by the FAA. Final CADD survey data required for FAA submission should adhere to the standards provided in DSM 12.

### **Section 3. Compliance with Environmental Requirements.**

(a) Compliance by the Airline. The Airline, in conducting any activity on the Airport, including any environmental response or remedial activities, shall comply with all applicable local, state, and federal environmental rules, regulations, statutes, laws or orders, (collectively, "Environmental Requirements").

The Airline agrees to ensure that any new facilities or any modifications or alterations to existing facilities are designed, constructed, operated and maintained in a manner that minimizes environmental impact through appropriate preventive measures and complies with all federal, state, and local environmental requirements, including the Airport's Tenant Development Guidelines, which shall be provided to Airline.

The Airline shall financially reimburse the City for penalties incurred by the City as a result of the release of any pollutant or contaminant from the premises covered in this Agreement resulting from or arising out of the Airline's operations.

The Airline shall conduct all environmental monitoring pertaining to Airline construction, operation, and maintenance activities required by Environmental Requirements. Monitoring records shall be retained as required by Environmental Requirements and available for inspection. The Airline is required to release any or all nonprivileged environmental data upon request from the City.

The Airline shall obtain all necessary federal, state, and local environmental permits and comply with all applicable federal, state, and local environmental permit requirements concerning its operations at the airport.

In the case of a release, spill, or leak caused by Airline construction, operation or maintenance activities, the Airline shall immediately call the Airport Communications Center at x4200. The Airline then shall, as soon as reasonably practicable, control and remediate the contaminated media as required by applicable Environmental Requirements.

(b) Review of Environmental Documents. The Airline, at the request of the City, shall make available for inspection and copying at the City's expense, upon reasonable notice and at reasonable times, any or all of the documents and materials that the Airline has prepared or submitted to any governmental agency. If there is a federal, state or local duty to file any notice or report of a release or threatened release of Regulated Materials on, under or about the leased facilities, the Airline shall provide a copy of such report or notice to the City.

For purposes of this Agreement, "Regulated Materials" shall mean any wastes, substances, radiation, or materials (whether solids, liquids, or gases) that are defined as or included in the definition of "hazardous substances", "hazardous wastes", "hazardous materials", "solid wastes", "universal wastes", "toxic substances", "toxic pollutants", "contaminants", "pollutants", "regulated substances", or words of similar import, under any applicable federal, Colorado, or local rules, regulations, statutes, laws, or orders.



(c) Access for Environmental Inspection. The City shall have a right of access to the leased facilities and to any of the improvements thereon without prior notice to inspect the same to confirm that the Airline is using the premises in accordance with the Environmental Requirements. Such inspection will not unreasonably interfere with Airline's operations. If the City finds evidence of non-compliance or threatened non-compliance with Environmental Requirements, the Airline, at the request of the City, shall conduct such testing and analysis as is necessary to ascertain whether the Airline is using the premises in compliance with all Environmental Requirements.

(d) Correction of Environmental Non-Compliance. If the Airline fails to comply in all material respects with any applicable Environmental Requirement, the City, after providing Airline with reasonable notice under the circumstances and reasonable opportunity to correct such noncompliance, in addition to its rights and remedies described elsewhere in this Agreement, at its election, may enter the premises and take such measures as may be necessary to insure compliance with the Environmental Requirements, all at the Airline's expense.

(e) Duty to Notify City. In the event of a release or threatened release of pollutants to the environment caused by Airline's use or occupancy of the premises, the Airline shall immediately notify the Airport Communications Center at x4200 and shall notify the City in writing as soon as reasonably practicable. In the event any claim, demand, action or notice is made against the Airline with regard to the Airline's failure or alleged failure to comply with any Environmental Requirements, the Airline, shall notify the City in writing as soon as reasonably practicable, and provide the City with copies of any written claims, demands, notices or actions so made.

(f) Environmental Remediation. The Airline shall undertake all actions as required by applicable Environmental Requirements to remedy or remove any Regulated Materials and any other environmental contamination discovered on or under the premises and/ caused by the Airline to bring the premises into compliance with all applicable Environmental Requirements in effect as of the date thereof.

The work shall be performed at the Airline's expense after the Airline submits to the City a written plan for completing such work and receives the prior written approval of the City, not to be unreasonably withheld, and the City shall have the right to review and inspect all such work at any time and at the City's expense using consultants and representatives of the City's choice. Cleanup levels for any environmental remediation work shall comply with applicable Environmental Requirements.

(g) Environmental Requirements for New Construction (including modifications or alterations to existing facilities). Throughout the construction activities for any facilities, the Airline is responsible for complying with all of the requirements under Denver International Airport Technical Specifications Section 01566 (Environmental Controls), Section 16642 (Cathodic Protection) and the Airports' Tenant Development Guidelines, all of which shall be provided to Airline.

(1) Air Pollution. All activities associated with the construction of the Facilities shall be performed under the Airline's (or its agent's) fugitive dust permit for

the construction project. The Airline is responsible for complying with the terms of its permit.

In order to comply with the above-referenced permit requirements, the Airline shall implement the procedures and techniques identified in Technical Specifications Section 01566.

(2) Water Pollution Controls. The Airline shall comply with the environmental specifications identified in Technical Specifications Section 01566.

(3) Soil Erosion and Sedimentation Control. The Airline shall comply with the environmental specifications for soil erosion and sediment control during construction, identified in Technical Specifications Section 01566. The Airline shall implement "best management practices" in preventing soil erosion and controlling sedimentation. The Airline shall obtain all necessary state and local permits for new development or construction. The Airline is responsible for the preparation and implementation of any plan required by the permits.

(4) Solid and Hazardous Waste Controls. This subsection applies to solid waste and hazardous waste as defined by federal and state regulations. Solid waste is defined as all putrescible and non-putrescible solid, semi-solid and liquid wastes, but does not include hazardous waste. The Airline is responsible to minimize the amount of solid and hazardous waste generated during construction activities. A commercially reasonable effort should be made to recycle generated construction debris. The Airline is responsible for the safe disposal of all solid and hazardous waste and shall dispose of such waste in accordance with Environmental Requirements and Mayor's Executive Order No. 115 (City requirement to direct all non-hazardous waste to DADS Landfill for disposal). Disposal of hazardous wastes on Denver International Airport property is prohibited. Recyclable waste is accepted at approved Airport recycling locations.

The Airline is responsible for complying with the solid and hazardous waste control requirements listed in Technical Specifications Section 01566.

(5) Noise and Vibration Control. Noise and vibration control requirements are listed in Technical Specifications Section 01566.

(h) Environmental Requirements for Operation and Maintenance.

(1) Storage Tanks and Ancillary Equipment. All underground storage tanks and pipelines, and any above-ground storage tanks and pipelines in contact with the ground, and any other underground metallic structures installed by Airline on Airport Property shall be integrated into a cathodic protection program. Airport officials shall be notified of any removal, addition, or modification of underground tanks, piping, and other metallic structures.

Wastewater from maintenance activities shall be pretreated with a water quality pre-treatment device. These devices shall be inspected and maintained by the Airline.

The Airline shall be responsible for all containment, treatment, and disposal of all fuel spills caused by Airline operations using "Best Management Practices." The Airline shall make all "best efforts" to recycle recovered fuel. A Spill Prevention Control and Countermeasures Plan shall be prepared and submitted according to federal (40 CFR 112) and state requirements.

Fuel storage tanks shall either be installed above ground, according to appropriate federal and state requirements, or underground in accordance with EPA regulations cited in 40 CFR Part 280 and State of Colorado CCR 1101-14.

(2) Air Pollution Control. The Airline shall obtain all necessary air emission control permits associated with operation and maintenance of its facilities.

(3) Water Pollution Control. The Airline shall obtain all necessary permits under NPDES (National Pollutant Discharge Elimination System) stormwater regulations (40 CFR Part 122-124), Colorado Pollutant Discharge System (CDDS), and industrial and sanitary pretreatment requirements.

The Airline shall comply with all federal and state water pollution control requirements. Upon the direction of the City, the Airline will be responsible for conducting all appropriate water quality monitoring related to its Denver International Airport operations. This data shall be released to the City upon the City's request.

(i) Waste Management Plan.

(1) The Airline shall prepare and submit to the City upon request a waste management plan outlining its program for recycling, waste management and waste minimization at DIA to the extent reasonably possible.

(2) The Airline shall make good faith efforts to participate in recycling programs offered by the Airport and to identify upon request locations on the Demised Premises at which recycling collection containers may be placed.