

1 BY AUTHORITY

2 ORDINANCE NO. _____
3 SERIES OF 2012

COUNCIL BILL NO. CB12-0341
COMMITTEE OF REFERENCE:
4 BUSINESS, WORKFORCE & SUSTAINABILITY

5 A BILL

6 For an ordinance approving a proposed 2012 Lease Amendment to the Airport
7 Use and Facilities Lease Agreement between the City and County of Denver and
8 United Airlines, Inc., related to leased space at Denver International Airport.

9
10 **BE IT ENACTED BY THE COUNCIL OF THE CITY AND COUNTY OF DENVER:**

11 **Section 1.** The proposed 2012 Lease Amendment to Airport Use and Facilities Lease
12 Agreement between the City and County of Denver and United Airlines, Inc. in the words and figures
13 contained and set forth in that form of Agreement available in the office and on the web page of City
14 Council and to be filed in the office of the Clerk and Recorder, Ex-Officio Clerk of the City and County
15 of Denver, under City Clerk's Filing No.1991-1077-I is hereby approved.

16
17 COMMITTEE APPROVAL DATE: May 2, 2012

18 MAYOR-COUNCIL DATE: May 8, 2012

19 PASSED BY THE COUNCIL _____ 2012

20 _____ - PRESIDENT

21 APPROVED: _____ - MAYOR _____ 2012

22 ATTEST: _____ - CLERK AND RECORDER,
23 EX-OFFICIO CLERK OF THE
24 CITY AND COUNTY OF DENVER
25

26 NOTICE PUBLISHED IN THE DAILY JOURNAL _____ 2012 _____ 2012

27
28 PREPARED BY: Helen Eckardt Berkman DATE: May 10, 2012

29 Pursuant to section 13-12, D.R.M.C., this proposed ordinance has been reviewed by the office of the
30 City Attorney. We find no irregularity as to form, and have no legal objection to the proposed
31 ordinance. The proposed ordinance is submitted to the City Council for approval pursuant to § 3.2.6
32 of the Charter.

33
34 Douglas J. Friednash, City Attorney

35 BY: _____, _____ City Attorney

36 DATE: May 10, 2012

2012 LEASE AMENDMENT

This 2012 Lease Amendment ("Amendment") is made and entered into as of the date indicated on the City's signature page, by and between the **CITY AND COUNTY OF DENVER**, a municipal corporation of the State of Colorado ("City"), party of the first part, and **UNITED AIRLINES, INC.**, a corporation organized and existing under and by virtue of the laws of the State of Delaware, and authorized to do business in the State of Colorado ("United"), party of the second part.

WHEREAS, the City and United entered into an Airport Use and Facilities Lease Agreement dated January 7, 1992, as amended and supplemented by a Stipulated Order dated November 21, 2003 providing for the assumption of the Lease as amended, pursuant to Section 365(a) of the Bankruptcy Code, and by the 2005, 2005-2, 2006, 2007, and 2009 Lease Amendments (hereinafter referred to together as the "Lease"); and

WHEREAS, the City has an ongoing program to reduce airline rates and charges, to provide a more competitive cost structure among its facilities, to reduce the debt associated with the automated baggage system at the Airport, and to allocate associated costs in a reasonable and not unjustly discriminatory manner, and, in furtherance of these goals, the City intends to take the following actions: (1) pay, refund, or defease bonds associated with the unused, basement portion of the baggage sortation space on Concourse B, approximately 159,000 square feet in size, and remove this space from the rentable space of DIA; (2) reclassify the apron portion of the baggage sortation space on Concourse B, approximately 192,000 square feet in size, to joint-use space, so that the space is classified consistently with similar space across all concourses; (3) pay, refund or defease bonds associated with the remaining portion of maintenance space associated with the automated baggage system, approximately 61,000 square feet in size, and remove this space from the rentable space of DIA; and (4) use an amount that is equivalent to approximately 75% of the revenues from the \$1.50 portion of the PFC to pay existing terminal complex eligible costs that have been approved by the FAA and permitted under the General Bond Ordinance, to minimize any impact to the average terminal complex rental rate as a result of any of the foregoing actions; and

WHEREAS, the City intends, upon taking the foregoing actions, to remove from the Lease, and relieve United of the requirement to pay rent in connection with (i) the unused, basement portion of the baggage sortation space on Concourse B and (ii) additional maintenance space associated with the automated baggage system, and further intends to charge United for the City's costs in connection with the reclassified joint use space based on the foregoing actions that are henceforth allocable to United; and

WHEREAS, United intends to maintain or increase certain activity levels at Denver International Airport ("DIA"), and further wishes to re-lease certain additional gates which had been temporarily removed from its leasehold; and

WHEREAS, United's activity levels at DIA have direct and indirect effects on DIA's revenues, making it reasonable to associate United's payment obligations with United's level of activity; and

WHEREAS, the parties intend to revisit the financial arrangement established hereunder no later than four years from the effective date and consider extending certain terms of this Amendment, if mutually deemed appropriate and advantageous to the parties; and

WHEREAS, the City and United now desire to further amend and supplement the Lease.

NOW THEREFORE, for and in consideration of the mutual covenants and agreements, herein contained, the City and United do hereby mutually undertake, promise and agree, each for itself and its successors, as follows:

1. Conditions Precedent. The obligations of the parties hereunder shall arise if, and only if, the City has taken all of the following actions, which the City agrees to pursue in good faith:
 - a. The City has paid, refunded, or defeased bonds associated with the unused, basement portion of the baggage sortation space on Concourse B, approximately 159,000 square feet in size, and removed this space from the rentable space of DIA.
 - b. The City has reclassified the apron portion of the baggage sortation space on Concourse B, approximately 192,000 square feet in size, to joint-use space.
 - c. The City has paid, refunded or defeased bonds associated with the remaining portion of maintenance space associated with the automated baggage system, approximately 61,000 square feet in size, and removed this space from the rentable space of DIA.
 - d. The City has directed the use of some, or all, of the revenues from the \$1.50 portion of the PFC to pay existing terminal complex eligible costs that have been approved by the FAA and permitted under the General Bond Ordinance, or the City alternatively has allocated other monies in such manner and to the extent necessary to minimize any impact to the average terminal complex rental rate as a result of the actions identified in subsections (a), (b) and (c) of this section.
2. Effective Date. The Effective Date of this Amendment shall be July 1, 2012, provided that the conditions precedent enumerated in the preceding paragraph have

occurred on or before that date. The Manager of Aviation and United's Vice President for Corporate Real Estate or his/her designee may extend the Effective Date for a period not to exceed six months by mutual written agreement, provided the conditions precedent in the preceding paragraph have been initiated but not yet fully implemented.

3. Term. This Amendment shall remain in full force and effect from the Effective Date until the expiration of the Lease; provided however, that the parties' obligations pursuant to Section 6 and Section 7 hereof shall expire on December 31, 2016, unless terminated prior to that date in accordance with Section 9 hereof ("Partial Termination Date").
4. Reduction in Demised Premises. The City agrees to permanently delete from United's demised premises under the Lease, and to relieve United of the obligation to pay rent pursuant to the Lease for (i) the unused, basement baggage sortation space on Concourse B and (ii) the remaining portion of maintenance space associated with the automated baggage system allocated to United pursuant to the Lease (collectively referred to herein as the "Released Space"). United shall remain obligated to pay rent on the apron portion of the baggage sortation space, reclassified as joint use space, in accordance with the ratemaking methodology prescribed by the Lease.
5. In-Lieu Payment. In lieu of rent, United agrees to pay the City for the City's costs to pay, refund or defease bonds associated with the Released Space ("In-Lieu Payments").
 - a. United's payment obligation hereunder shall be amortized on a monthly (or annual) basis over the current remaining term of the Lease, in accordance with the schedule attached hereto as **Exhibit J-2**.
 - b. Any In-Lieu Payments made under this Section 5 shall be made as an offset to United's portion of the annual Airline Revenue Credit Account. To the extent that the In-Lieu Payment exceeds the amount of United's portion of the annual Airline Revenue Credit Account in a given year, United shall pay the difference to the City within 180 days from August 1 of the same year or the date of the final year-end settlement report of that year is published by the City or its representatives, whichever is later.
 - c. Any In-Lieu Payments made by United pursuant to Section 7.a, Section 7.b or Section 7.c shall not be included in the revenues used in a given year to determine United's portion of the annual Airline Revenue Credit Account.
6. In-Lieu Payment Relief. Commencing on the Effective Date and until the Partial Termination Date, the City will relieve United of the obligation to make In-Lieu Payments for a given calendar year, provided that United maintains Available Seat Miles ("ASMs") at DIA at a level equal to or greater than 22.781 billion in such

calendar year ("ASM Baseline"), subject to Section 7 below. For purposes of calculating ASMs, in addition to United's commercial flights at DIA, any DIA commercial flights scheduled by any other subsidiary of United Continental Holdings, Inc., as well as any DIA commercial flights scheduled by an operating carrier under a capacity purchase and/or prorate agreements with a subsidiary of United Continental Holdings, Inc. shall count towards the annual calculation of ASMs. Only flights marketed as and offering all seats for sale, except those seats withheld for sale for operational or safety reasons, as United or United Express qualify under the prior sentence; code share flights operated by carriers other than a subsidiary of United Continental Holdings, Inc., whether Star Alliance partner carriers or not, are specifically excluded. Scheduled flights include only those flights included in United/United Express' published schedules and which are not withdrawn for sale prior to operation.

7. Reduction in In-Lieu Payment Relief. Commencing on the Effective Date and until the Partial Termination Date, should United fail to maintain its ASMs at the ASM Baseline, as measured on an annual calendar year basis (or as prorated during the second half of 2012 for the 2012 portion), United shall not be deemed to be in default of the Lease or this Amendment, provided United makes In-Lieu Payments according to the following formula:
 - a. For every 0.25% United is below the ASM Baseline, as measured on an annual calendar year basis (or as prorated during the second half of 2012 for the 2012 portion), United will pay the City \$937,500 as In-Lieu Payment. These quarter point increments will accrue if United is less than 1% below the ASM Baseline. For example, if United is exactly 1% below the ASM Baseline, United will be obligated to pay the City \$3,750,000 as the In-Lieu Payment.
 - b. For every additional 1% decrease below the ASM Baseline, as measured on an annual calendar year basis (or as prorated during the second half of 2012 for the 2012 portion), United will pay the City \$3,750,000, truncated to the tenth of a percent and rounded to the nearest 1% increment. For example, if United is 2.5% below the ASM Baseline, United will be obligated to pay the City \$11,250,000.
 - c. In the event that the ASMs of United at DIA falls below 21.8 billion, as measured on an annual calendar year basis (or as prorated during the second half of 2012 for the 2012 portion), United shall pay the full amount of the In-Lieu Payment; provided however, that United will remain eligible to receive In-Lieu Payment relief in a subsequent year in which United meets the conditions for such relief set forth herein, prior to the Partial Termination Date.
 - d. In the event that application of the formula prescribed by this Section 7 results in a payment obligation on the part of United that exceeds the annual In-Lieu Payment, as prescribed in the schedule attached at **Exhibit J-2**, the City may, at its sole discretion, re-direct all or a portion of the amount referred to in Section

1(d) above from the existing terminal complex eligible costs to other eligible costs.

8. Concourse B Premises. Certain Concourse B Premises, as more fully described on the attached **Exhibits C and D-A**, which were removed from United's leasehold in the 2009 Amendment and were to revert back to United on January 1, 2016, are instead returned to the leasehold and revert back to United as of the Effective Date.
9. Partial Termination. The City may, at its sole discretion, upon at least 30 days written notice, terminate the In-Lieu Payment relief provided hereunder, upon the occurrence of any of the following:
 - a. the ASM of United at DIA falls below 21.13 billion;
 - b. an actual or planned decline in capacity of more than 50% as measured by annual ASMs by either of DIA's other two largest carriers on a year-over-year monthly basis (e.g., year-end June 2013 as compared to year-end June 2012), provided that United will be eligible for pro-rated In-Lieu Payment relief for the year in which the decline in ASM by either of DIA's two largest carriers occurred;
 - c. a deficiency in any of the required Airport fund balances, or an inability on the part of the City to provide the In-Lieu Payment relief consistently with its obligations under its bond ordinances;
 - d. an indication from any rating agency of a negative credit outlook, credit watch, or downgrade of DIA's credit rating or the credit rating on any outstanding DIA obligations is likely unless the In-Lieu Payment relief ceases;
 - e. operating cash balances are insufficient and continuation of the In-Lieu Payment relief would jeopardize the ongoing operation of the Airport;
 - f. the Federal Aviation Administration ("FAA") has declared or, based on guidance received from the FAA, Airport management has reasonably concluded the FAA is likely to declare that providing the In-Lieu Payment relief will violate the City's federal grant assurances or federal law, or is otherwise deemed prohibited by law by a court of competent jurisdiction; or
 - g. the In-Lieu Payment relief is or becomes impracticable to apply without impacting the rates and charges of all airlines or the credit provided to any signatory airline through the Airline Revenue Credit Account, provided that United shall be afforded the opportunity to demonstrate how the impacts can be avoided, including by foregoing all or some portion of In-Lieu Payment relief for which United may be eligible hereunder.
10. Reimbursement. In the event that the In-Lieu Payment relief is terminated under Section 9 hereof, reimbursement by United to the City of In-Lieu Payments previously relieved shall only be required if warranted by a ruling or opinion of the FAA or a court of competent jurisdiction.
11. Severability. No determination by any court or the FAA that any provision of this Amendment is invalid or unenforceable in any instance shall affect the validity or enforceability of (a) any other such provision, or (b) such provision in any

circumstance not controlled by such determination with each remaining provision construed to be valid and enforceable to the fullest extent allowed by and construed, to the extent possible, as being consistent with applicable law.

12. Amendment Subordinate to Federal Law and Grant Assurances. Federal law requires that sponsors of public airports accepting Airport Improvement Program ("AIP") grants agree to comply with all federal grant assurances (see 49 U.S.C. §47107). Under the AIP, the City has entered into agreements with the FAA and has agreed to specific federal obligations, including without limitation the obligations related to economic nondiscrimination, the use of airport revenue, and maintenance of a self-sustaining rate structure. Accordingly, this Amendment is in all respects subordinate and subject to the City's obligations to comply with federal law and its federal grant assurances.
13. Amendment Subordinate to Bond Ordinances. This Amendment is in all respects subject and subordinate to any and all City bond ordinances applicable to DIA and to any other bond ordinances which should amend, supplement or replace such bond ordinances.
14. Governing Law. This Amendment shall be governed by and construed in accordance with the laws of the State of Colorado.
15. No Prior Appropriation. This Amendment does not commit any present funding by the City. The obligations of the City under this Amendment shall extend only to monies appropriated for the Airport System by the Denver City Council, subject to the City's legally required budgeting, authorization, and appropriation processes and bond ordinance obligations and requirements. The City does not through this Amendment irrevocably pledge present cash reserves of the Airport System for payments in future years, and this Amendment is not intended to create a multiple fiscal year direct or indirect debt or obligation of airport revenues.
16. Continued Effectiveness of Lease. Except as expressly provided herein, all of the terms and conditions of the Lease are and shall remain in full force and effect.
17. Effectiveness. This 2012 Lease Amendment is expressly subject to, and shall not be effective or binding on the City until, approval by the Denver City Council and full execution by all signatories of the City.

[SIGNATURE PAGES FOLLOW]

PREFERENTIAL AIRCRAFT PARKING POSITIONS

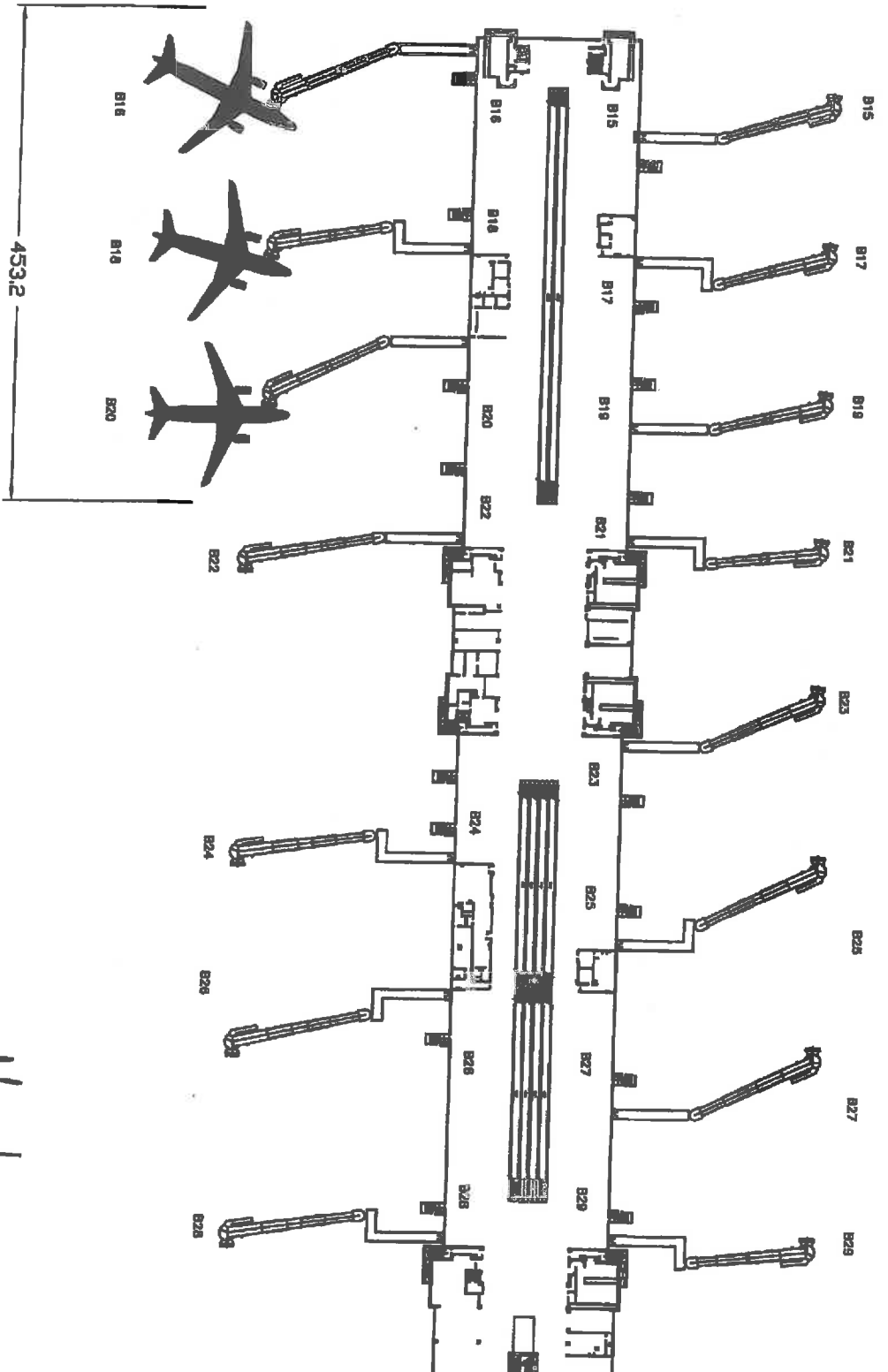

453.2
United

SCALE 1" = 120'

NOTE: This exhibit depicts only square footage of leased area based upon planning data and is not intended to address construction details.

MANAGER OF DESIGN

Handwritten signature: P. Frank York

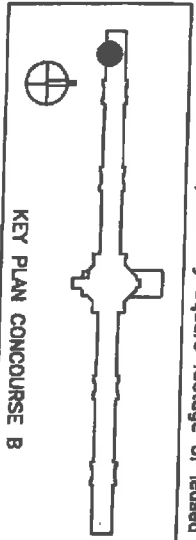

KEY PLAN CONCOURSE B



REVISED

DENVER INTERNATIONAL AIRPORT

EXHIBIT C
PARKING POSITIONS
UNITED AIRLINES

CC#: unit 1

DATE: 04/30/12

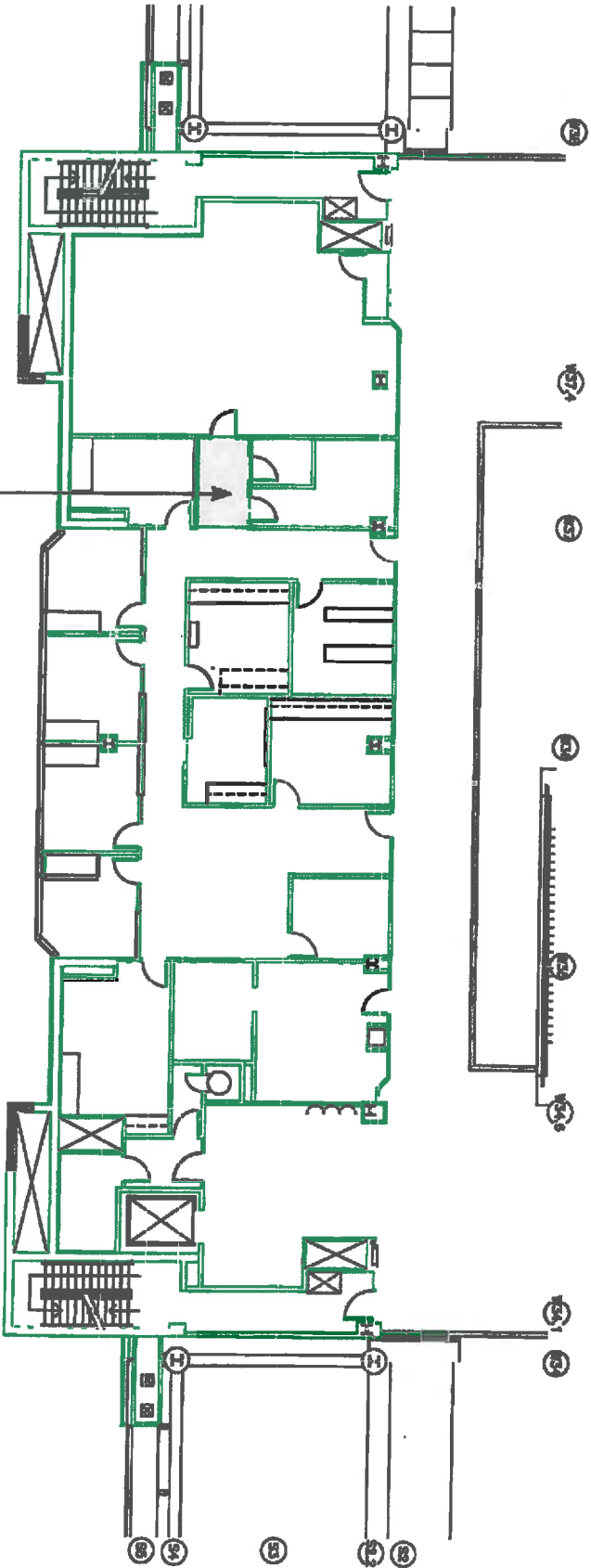

United Airlines
R18-1-4-W37-S4-1
70.5 sq. ft.



SCALE 1" = 20.00'



NOTE: This exhibit depicts only square footage of leased area based upon planning data and is not intended to address construction details.

Frank M. Horn
MANAGER OF DESIGN

- CONC. WALL, PER STD
 - INTERIOR WALL, PER STD
 - GLASS WALL, PER STD
 - STEEL LAME, PER STD
 - ① column
 - ② column
- N/C = Not Included
On Items w/ Sq. Ft. Only

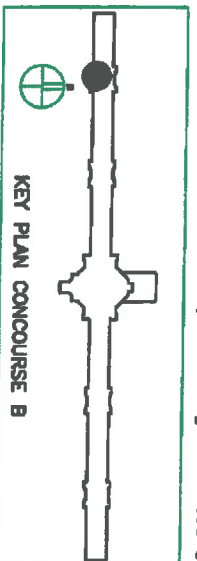

REVISED	DENVER INTERNATIONAL AIRPORT
	EXHIBIT D-A
	Concourse B Mezz. Level
	United Airlines
CC#: uat1	DATE: 04/30/12

R18-1-4-15-21

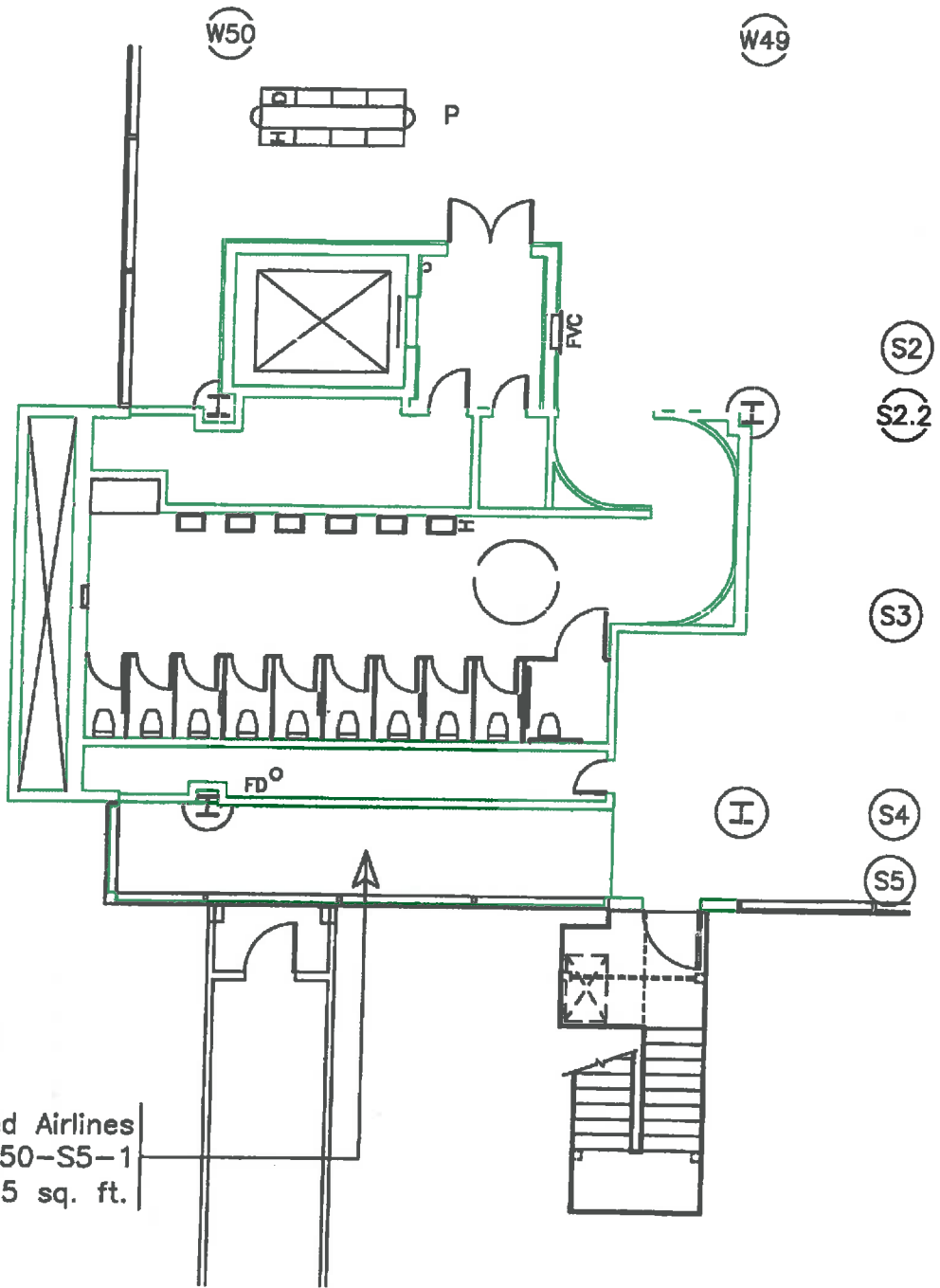

United Airlines
 R18-1-3-W50-S5-1
 176.5 sq. ft.

CONC. WALL (BY STD)
 REINFORCED WALL (BY STD)
 GLASS WALL (BY STD)
 TERRAZZO FLOOR LINE
 (H) (S) COLUMNS
 NIC = Not Included
 (In Layout or By P.C. Only)

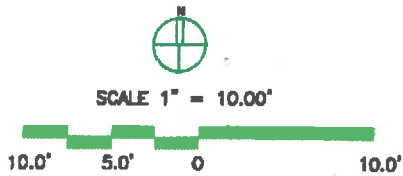

Ronald Horn

MANAGER OF DESIGN

NOTE: This exhibit depicts only square footage of leased area based upon planning data and is not intended to address construction details.

 KEY PLAN CONCOURSE B		REVISED	DENVER INTERNATIONAL AIRPORT	
			EXHIBIT D-A Concourse B Conc. Level United Airlines	
		CC#:	ual1	DATE: 04/30/12

R18-1-3-2-36

309 310 311 312 313 314 315 316 317 318 319 320



3 P

3 P

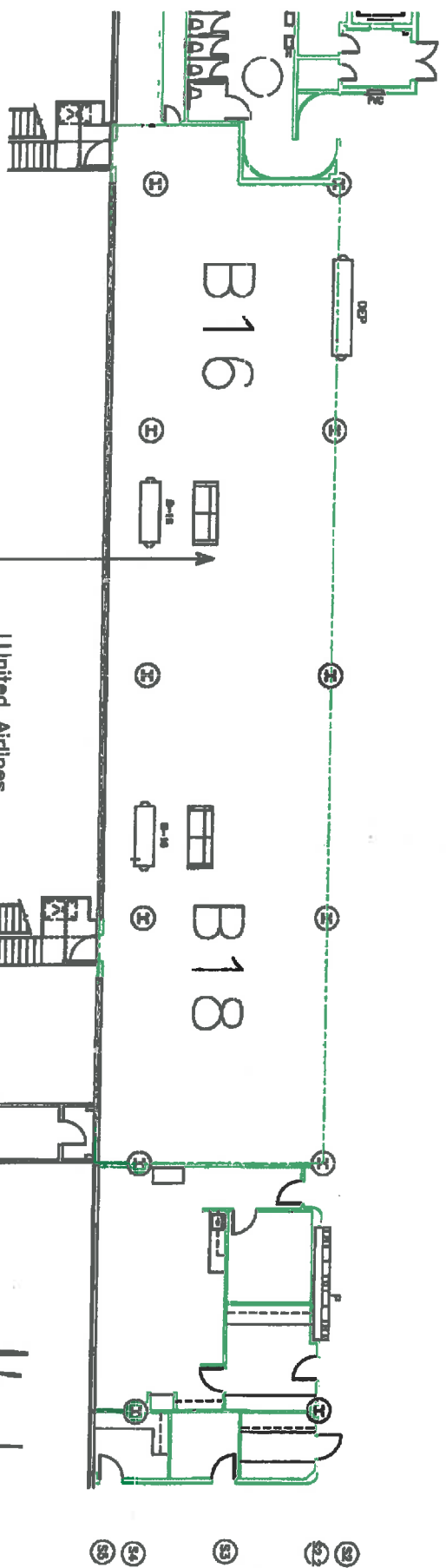

United Airlines
R18-1-3-W49-S5-1
3949.7 sq. ft.

Final
MANAGER OF DESIGN

SCALE 1" = 20.00'



NOTE: This exhibit depicts only square footage of leased area based upon planning data and is not intended to address construction details.

- CONC. WALL, (BY CITY)
- REINFORCED CONC. WALL, (BY CITY)
- GLASS WALL, (BY CITY)
- TRANSIT SERVICE LINK
- ① ② ③ ④ ⑤ ⑥ ⑦ ⑧ ⑨ ⑩ ⑪ ⑫ ⑬ ⑭ ⑮ ⑯ ⑰ ⑱ ⑲ ⑳ ㉑ ㉒ ㉓ ㉔ ㉕ ㉖ ㉗ ㉘ ㉙ ㉚ ㉛ ㉜ ㉝ ㉞ ㉟ ㊱ ㊲ ㊳ ㊴ ㊵ ㊶ ㊷ ㊸ ㊹ ㊺ ㊻ ㊼ ㊽ ㊾ ㊿

NIC = Not Included
in terms of Ag. To City

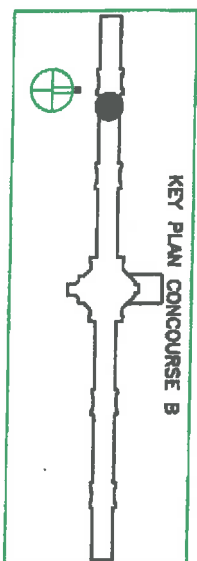

REVISID	DENVER INTERNATIONAL AIRPORT
	EXHIBIT D-A
	Concourse B Conc. Level
	United Airlines
CC#: udl1	DATE: 04/30/12

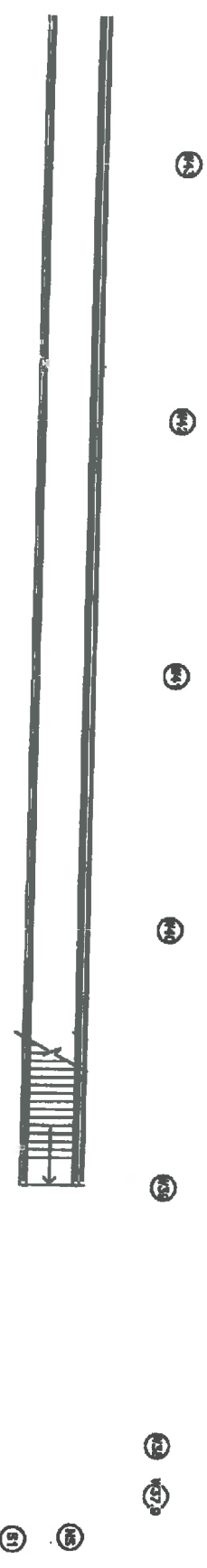

United Airlines
R18-1-3-W42-SS-1
2387.7 sq. ft.

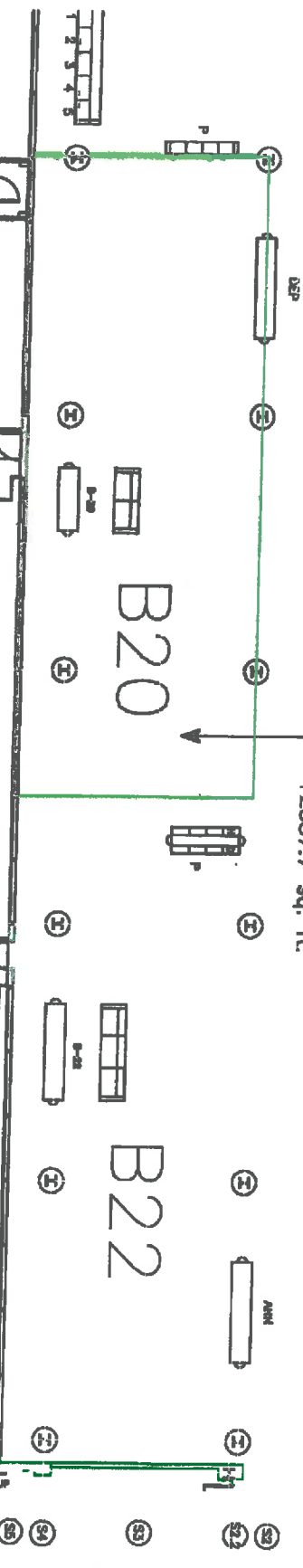

- CONC. WALL (BY STD)
- STRUCTURAL WALL (BY STD)
- GLASS WALL (BY STD)
- THINER LANDING LANE
- ② contains
- Ⓜ = Not included (for items of sq. ft. only)

SCALE 1" = 20.00'



NOTE: This exhibit depicts only square footage of leased area based upon planning data and is not intended to address construction details.

Frank [Signature]
MANAGER OF DESIGN

<p>KEY PLAN CONCOURSE B</p>		REVISED	DENVER INTERNATIONAL AIRPORT EXHIBIT D-A Concourse B Conc. Level United Airlines
		ccf: uat1	

940

941

942



91

92

93

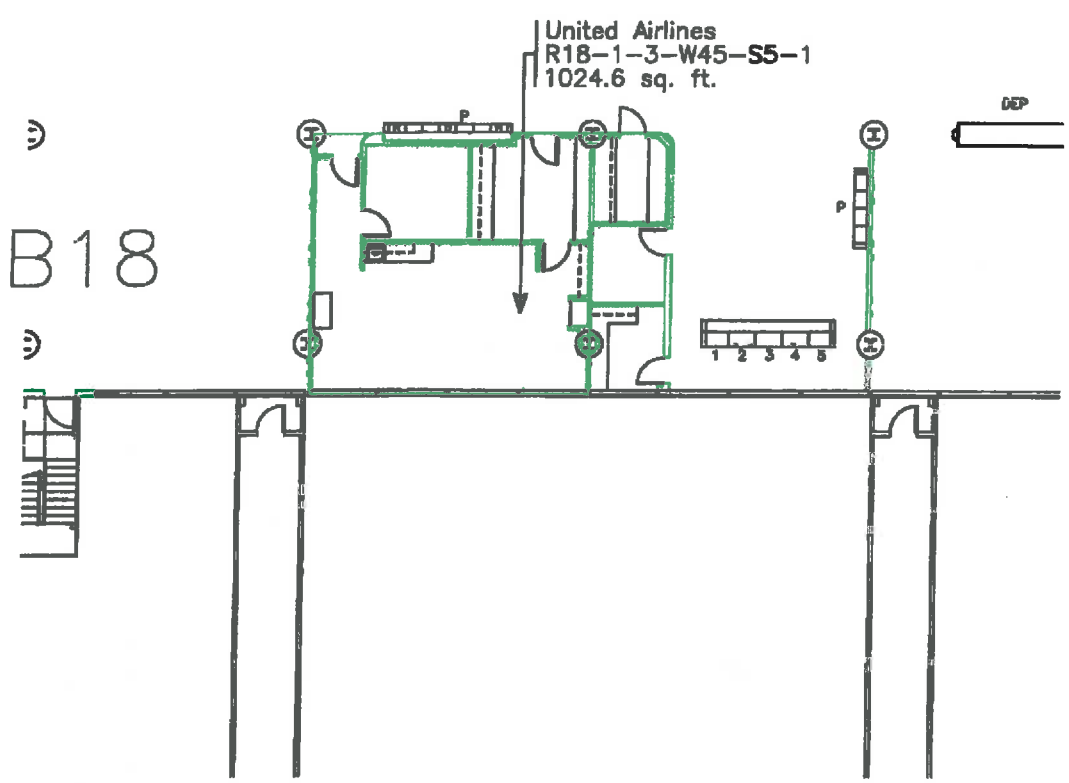

94

95

96

97

98

COND. WALL (BY CITY)
 STRUCTURAL WALL (BY CITY)
 GLASS WALL (BY CITY)
 TYPICAL LEASE LINE
 COLUMNS
 NIC = Not Included
 (in Lease or Sp. Pk. Sale.)

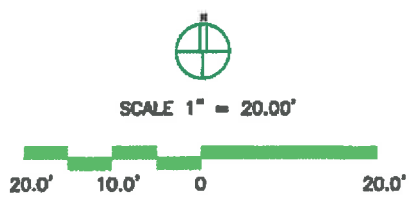

Ronald Horn
 MANAGER OF DESIGN

NOTE: This exhibit depicts only square footage of leased area based upon planning data and is not intended to address construction details.

 KEY PLAN CONCOURSE B		REVISED	DENVER INTERNATIONAL AIRPORT	
			EXHIBIT D-A Concourse B Conc. Level United Airlines	
		CC#: ual1	DATE: 04/30/12	

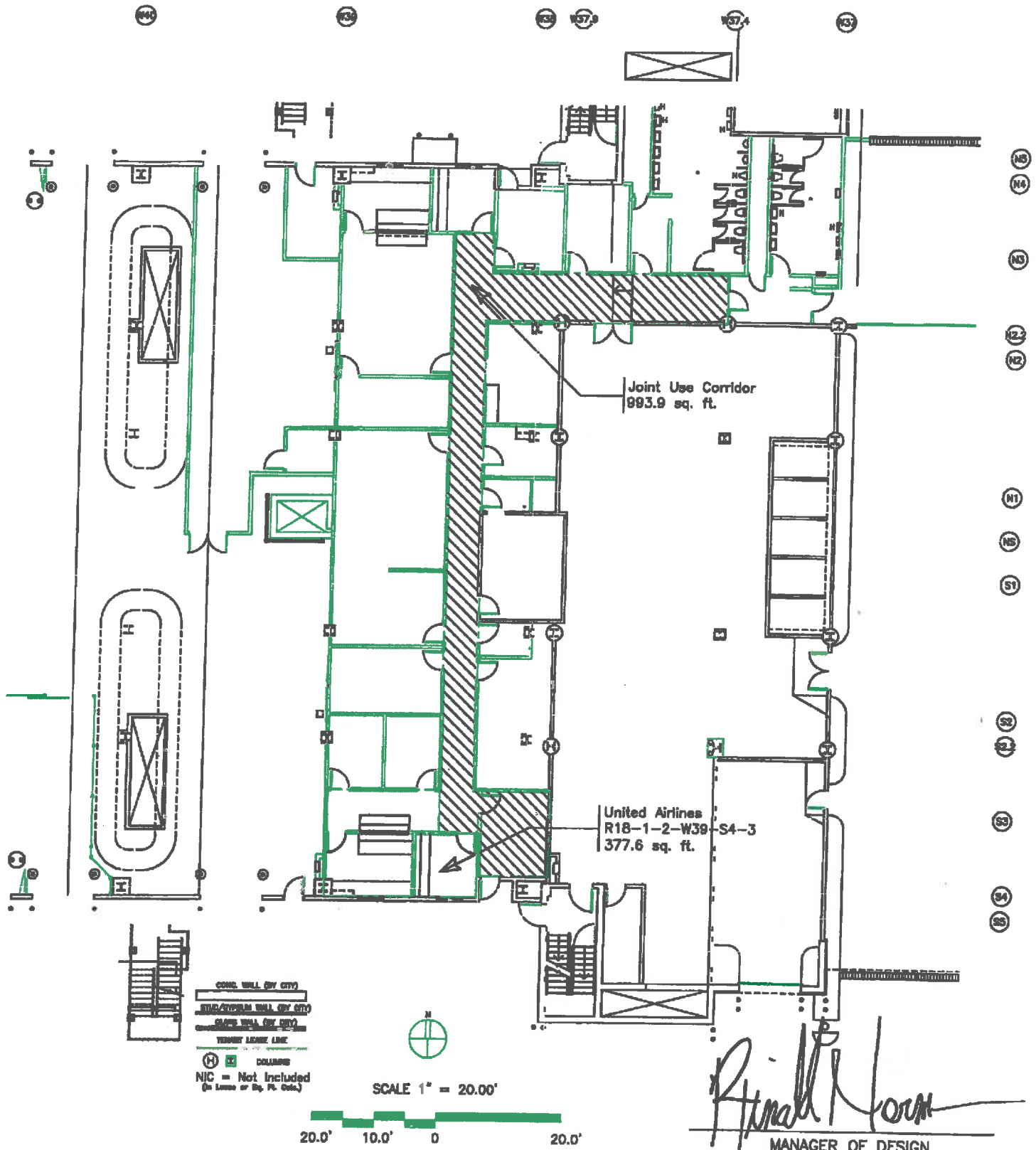

NOTE: This exhibit depicts only square footage of leased area based upon planning data and is not intended to address construction details.

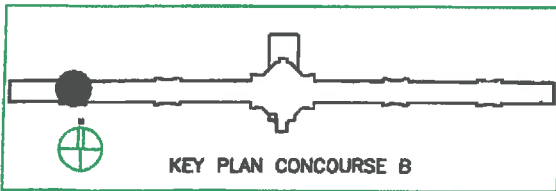

REVISED	DENVER INTERNATIONAL AIRPORT
	EXHIBIT D-A Concourse B Apron Level United Airlines
CC#: ual1	DATE: 04/30/12

R18-1-2-15-8

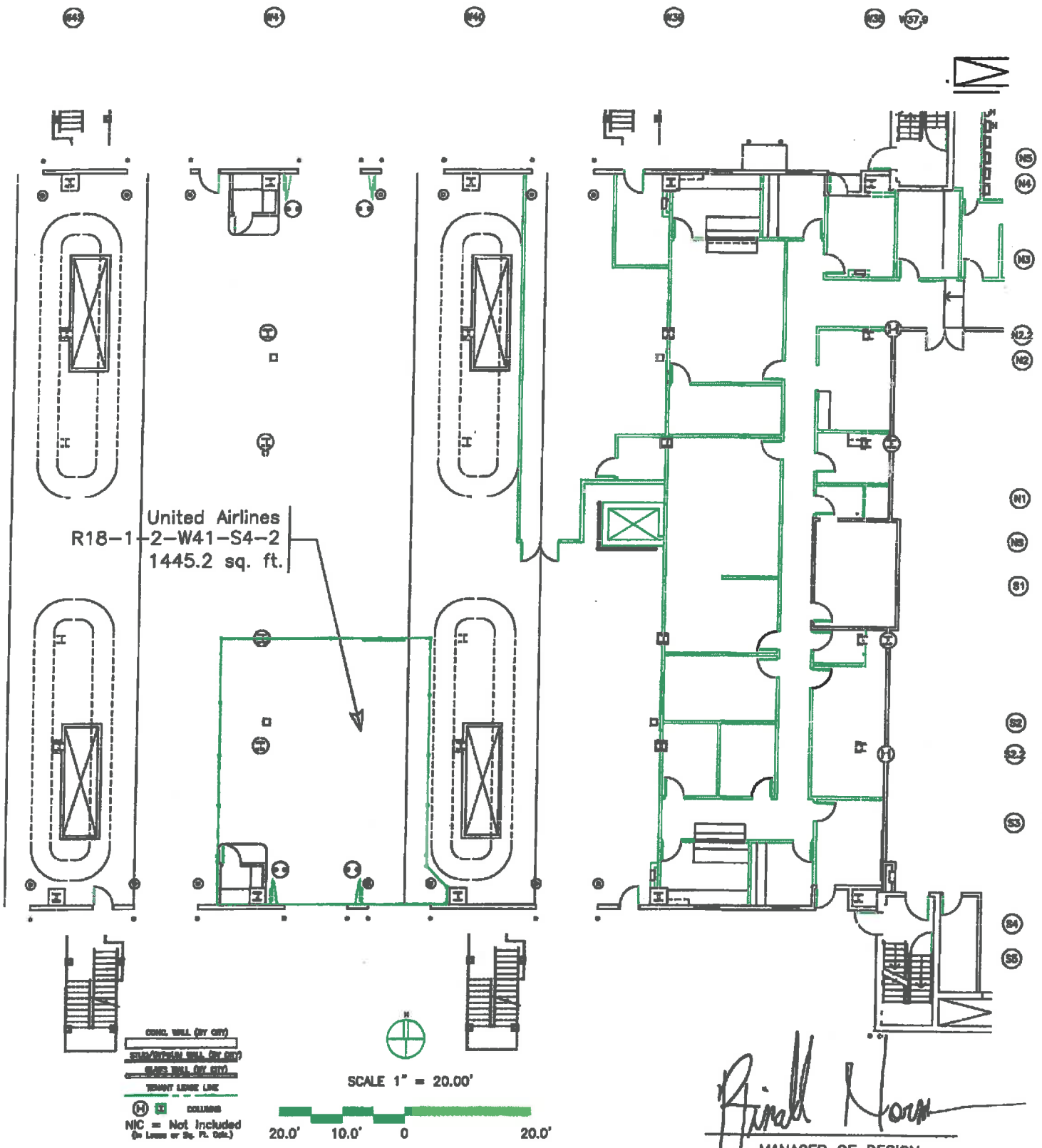

NOTE: This exhibit depicts only square footage of leased area based upon planning data and is not intended to address construction details.

<p>KEY PLAN CONCOURSE B</p>		REVISED	DENVER INTERNATIONAL AIRPORT	
			EXHIBIT D-A Concourse B Apron Level United Airlines	
		CC#: ual1	DATE: 04/30/12	

Period Ending	Existing UAL Lease Obligation			Amortization of Defeasance Cost(1)			Existing Lease Payments	Total Payments	Difference
	ABS Associated Debt	Bag Sort Associated Debt	Total Debt Service	Principal Portion(1)	Interest Portion(2)	Total In-Lieu Payment			
11-15-2012	2,536,411	6,659,553	9,195,964	2,382,275	2,448,083	4,840,358	4,597,982	9,438,340	(242,376)
11-15-2013	2,481,147	6,514,453	8,995,601	4,921,387	4,759,328	9,680,715	-	9,680,715	(685,114)
11-15-2014	2,480,344	6,512,342	8,992,686	5,202,881	4,477,824	9,680,715	-	9,680,715	(688,029)
11-15-2015	2,438,677	6,402,943	8,841,619	5,600,496	4,180,219	9,680,715	-	9,680,715	(839,096)
11-15-2016	2,524,272	6,627,680	9,151,952	5,815,125	3,865,591	9,680,715	-	9,680,715	(528,763)
11-15-2017	2,403,735	6,311,202	8,714,937	6,147,750	3,532,965	9,680,715	-	9,680,715	(985,778)
11-15-2018	2,314,762	6,077,596	8,392,358	6,499,401	3,181,314	9,680,715	-	9,680,715	(1,266,357)
11-15-2019	2,512,149	6,595,850	9,107,999	6,871,167	2,809,548	9,680,715	-	9,680,715	(572,716)
11-15-2020	2,516,209	6,606,509	9,122,717	7,264,197	2,416,518	9,680,715	-	9,680,715	(557,988)
11-15-2021	2,455,289	6,446,560	8,901,849	7,679,710	2,001,008	9,680,715	-	9,680,715	(778,868)
11-15-2022	2,579,382	6,772,323	9,351,885	8,118,989	1,561,726	9,680,715	-	9,680,715	(329,030)
11-15-2023	2,466,405	6,475,745	8,942,150	8,583,395	1,097,320	9,680,715	-	9,680,715	(738,565)
11-15-2024	2,029,169	5,327,747	7,356,916	8,074,365	606,350	9,680,715	-	9,680,715	(2,323,799)
11-15-2025	426,230	1,119,100	1,545,330	1,526,156	87,286	1,613,453	-	1,613,453	(68,123)
Totals	32,164,160	84,449,604	116,613,764	85,597,303	37,025,088	122,622,391	4,597,982	127,220,373	(10,608,610)

(1) Preliminary, based upon preliminary estimates by the City's financial advisor, subject to change based on actual cost of executing defeasance
(2) Based upon average cost of DIA fixed rate debt of 5.720%

Contract Control Number: PLANE-XC2X000-06

Contractor Name:

IN WITNESS WHEREOF, the parties have set their hands and affixed their seals at Denver, Colorado as of

SEAL

CITY AND COUNTY OF DENVER

ATTEST:

By _____

APPROVED AS TO FORM:

REGISTERED AND COUNTERSIGNED:

DOUGLAS J. FRIEDNASH, Attorney
for the City and County of Denver

By _____

By _____

By _____



UNITED AIRLINES, INC.

By: Kate Gebo

Title: Vice President Corporate Relations
Estate

PARTY OF THE SECOND PART



