

CITY AND COUNTY OF DENVER

STATE OF COLORADO



**DENVER**  
THE MILE HIGH CITY

DEPARTMENT OF PUBLIC WORKS

Contract Documents

Contract Number: 201843656



General Sanitary – Cherry Creek Improvements

August 1, 2018



## NOTICE OF APPARENT LOW BIDDER

**Insituform Technologies, LLC  
17988 Edison Avenue  
Chesterfield, MO 63005**

The EXECUTIVE DIRECTOR OF PUBLIC WORKS has considered the Bids submitted on **August 30, 2018**, for work to be done and materials to be furnished in and for:

### CONTRACT 201843656 - General Sanitary – Cherry Creek Improvements

as set forth in detail in the Contract Documents for the City and County of Denver, Colorado. It appears that your Bid is fair, equitable, and to the best interest of the City and County; therefore, said Bid is hereby accepted at the bid price contained herein, subject to the approval and execution of the Contract Documents by the City in accordance with the Charter of the City and County of Denver, and to your furnishing the items specified below. The award is based on the total bid items: **3-7a through 01-55.26.01A (Twenty-Five [25] total bid items which includes one Allowance Account the total estimated cost thereof being: Two Million One Hundred Ninety-Five Thousand Seven Hundred Sixty-Nine Dollars and Fifty Cents (\$2,195,769.50).**

It will be necessary for you to appear forthwith at the office of the Department of Public Works, Contract Administration, 201 W. Colfax Ave., Dept 614, Denver, Colorado 80202, to receive the said Contract Documents, execute the same and return them to the Department of Public Works, Contract Administration within the time limit set forth in the Bid Package Documents.

In accordance with the requirements set forth in the Contract Documents, you are required to furnish the following documents:

- a. Insurance Certificates: General Liability and Automotive Liability, Workman's Compensation and Employer Liability;
- b. Payment and Performance Bond along with One original Power of Attorney relative to Performance and/or Payment Bond; and,

All construction Contracts made and entered into by the City and County of Denver are subject to Affirmative Action and Equal Opportunity Rules and Regulations, as adopted by the Manager of Public Works, and each contract requiring payment by the City of one-half million dollars (\$500,000.00) or more shall first be approved by the City Council acting by ordinance and in accordance with Section 3.2.6 of the Charter of the City and County of Denver.

Prior to issuance of Notice to Proceed, all Equal Opportunity requirements must be completed. Additional information may be obtained by contacting the Director of Contract Compliance at (720-913-1700).

Denver Public Works/Office of the Executive Director  
201 West Colfax Avenue, Dept 608 | Denver, CO 80202  
[www.denvergov.org/dpw](http://www.denvergov.org/dpw)  
p. 720.865.8630 | f. 720.865.8795



**NOTICE OF APPARENT LOW BIDDER**

CONTRACT NO. 201843656

Page 2

The Bid Security submitted with your Bid, will be returned upon execution of the Contract and furnishing of the Performance Bond. In the event you should fail to execute the Contract and to furnish the performance Bond within the time limit specified, said Bid Security will be retained by the City and County of Denver as liquidated damages, and not as a penalty for the delay and extra work caused thereby.

Dated at Denver, Colorado this 10<sup>th</sup> day of Sept 2018.

CITY AND COUNTY OF DENVER

By

Eulois Cleckley

Executive Director of Public Works

cc: Kristen Moore (CAO), Treasury ([taxauditadmin@denvergov.org](mailto:taxauditadmin@denvergov.org)), Cindy Ackerman (DSBO), DSBO Inbox ([dsbo@denvergov.org](mailto:dsbo@denvergov.org)), Jim Cokeley, Arielle Denis (Prev Wage), Prevailing Wage([prevailingwage@denvergov.org](mailto:prevailingwage@denvergov.org)), File.

Denver Public Works/Office of the Executive Director  
201 West Colfax Avenue, Dept 608 | Denver, CO 80202

[www.denvergov.org/dpw](http://www.denvergov.org/dpw)

p. 720.865.8630 | f. 720.865.8795

**CITY AND COUNTY OF DENVER**  
**STATE OF COLORADO**



**DENVER**  
**THE MILE HIGH CITY**

**DEPARTMENT OF PUBLIC WORKS**

**Bid Form Package**

**Contract Number: 201843656**



**General Sanitary – Cherry Creek Improvements**

**August 1, 2018**

**CITY AND COUNTY OF DENVER  
DEPARTMENT OF PUBLIC WORKS**

**TABLE OF CONTENTS  
FOR  
BID FORM AND SUBMITTAL PACKAGE**

Table of Contents	BF-1
Bidder's Checklist	BF-2 through BF-3
Bid Form and Submittal Package Acknowledgment Form	BF-4 through BF-5
Bid Form	BF-6 through BF-8
List of Proposed Minority/Woman Business Enterprise(s)	BF-9 through BF-12
Commitment to Minority/Woman Business Enterprise Participation	BF-13
Minority/Woman Business Enterprise Letter(s) of Intent & Checklist	BF-14 through BF-15
Joint Venture Affidavit	BF-16
Joint Venture Eligibility Form	BF-17 through BF-19
Bid Bond	BF-20
Diversity and Inclusiveness in City Solicitations Form	BF-21 through BF-24



*This Checklist is provided solely for the assistance of the bidders, and need not be returned by Bidders with your BID FORM PACKAGE.*

**BIDDER'S CHECKLIST**

These forms comprise the Bid Form and Submittal Package. Designated forms must be completed and turned in at the time of Bid Opening. Bidders should refer to the Contract Documents, particularly the Instructions to Bidders, accompanying this package, in completing these forms.

FORM/ PAGE NO.	COMMENTS	COMPLETE
BF-4 – BF-5	a.) Legal name, address, Acknowledgment signature and attestation (if required.)	<input checked="" type="checkbox"/>
BF-6+	a.) Fill in individual bid item dollars and totals in Numerical figures only b.) Complete all blanks c.) Legal name required	<input checked="" type="checkbox"/> <input checked="" type="checkbox"/> <input checked="" type="checkbox"/>
BF-7	a.) Write out bid total or bid totals in words and figures in the blank form space(s) provided b.) Calculate Textura® Construction Payment Management System Fee from chart on pg. BF-3 and write % and fee in the space provided	<input checked="" type="checkbox"/> <input checked="" type="checkbox"/>
BF-8	a.) List all subcontractors who are performing work on this project	<input checked="" type="checkbox"/>
BF-9 – BF-10	a.) Fully complete List of Proposed Minority /Woman Business Enterprise Bidders, Subcontractors, Suppliers, Manufacturers, or Brokers – check appropriate boxes.	<input checked="" type="checkbox"/>
BF-11	a.) Complete all blanks b.) If Addenda have been issued, complete bottom section.	<input checked="" type="checkbox"/> <input checked="" type="checkbox"/>
BF-12	a.) Complete appropriate sections - signature(s) required. b.) If corporation, then corporate seal required.	<input checked="" type="checkbox"/> <input checked="" type="checkbox"/>
BF-13	a.) Fully complete Commitment to Participation	<input checked="" type="checkbox"/>
BF-16	a.) If applicable, fully complete Joint Venture Affidavit (Submit 10 days prior to Bid Opening date)	<input checked="" type="checkbox"/>
BF-17 – BF-19	a.) If applicable, fully complete Joint Venture Eligibility Form (Submit 10 days prior to Bid Opening date)	<input checked="" type="checkbox"/> N/A
BF-20	a.) Fill in all Bid Bond blanks b.) Signatures required c.) Corporate Seal if required d.) Dated e.) Attach Surety Agents Power of Attorney or Certified or cashier's check made out to the Manager of Revenue referencing Bidder's Company and Contract Number.	<input checked="" type="checkbox"/> <input checked="" type="checkbox"/> <input checked="" type="checkbox"/> <input checked="" type="checkbox"/> <input checked="" type="checkbox"/>
BF-21- BF-24	a.) Each bidder, as a condition of responsiveness to this solicitation, shall <u>complete and return</u> the "Diversity and Inclusiveness in City Solicitations Information Request Form" with their Bid.	<input checked="" type="checkbox"/>

## Textura ® Construction Payment Management System (CPM System)

Contractor recognizes and agrees that it shall be required to use the Textura® Construction Payment Management System (CPM System) for this Project. All fees associated with the CPM System are to be paid by the Contractor for billings for work performed. Bidders are required, when preparing a bid, to enter the price of the CPM service on the line provided for the service. The fee is all inclusive of all subcontractor, project and subscription fees associated with the CPM system. The bidder will calculate the fee based on a percentage of their total bid, and then should include it on the line item provided in the bid form labeled “Textura® Construction Payment Management System Fee”. This expense becomes part of the contract and billable to the City. All costs including but not limited to costs associated with training, entering data or utilizing Textura other than the Textura Construction Payment Management System Fee are overhead and shall not be reimbursed by the City. Contractor is responsible for any tax on Textura fee. As with other taxes, the City will not reimburse Contractor for this cost and therefore this cost should be included in Contractor’s bid. Textura will invoice the awarded contractor directly.

Project Value	Project Fee (GC + Sub Usage)
\$250,000 - \$499,999.99	\$1,625
\$500,000 - \$999,999.99	\$3,250
\$1,000,000 - \$2,999,999.99	\$5,850
\$3,000,000 - \$4,999,999.99	\$9,100
\$5,000,000 - \$9,999,999.99	\$12,220
\$10,000,000 - \$19,999,999.99	\$20,345
\$20,000,000 - \$49,999,999.99	\$32,500
\$50,000,000 - \$99,999,999.99	\$48,750
\$100,000,000 - \$199,999,999.99	\$69,095
\$200,000,000 - \$299,999,999.99	\$85,345
\$300,000,000 - \$399,999,999.99	\$109,720
\$400,000,000 - \$499,999,999.99	\$142,220
\$500,000,000 - \$999,999,999.99	\$162,500
\$1,000,000,000 - \$1,999,999,999.99	\$345,345
\$2,000,000,000 - \$4,999,999,999.99	\$650,000
\$5,000,000,000 - \$9,999,999,999.99	\$1,015,625
\$10,000,000,000 or greater	\$1,503,125

For more information:

<http://www.denvergov.org/content/denvergov/en/contract-administration/bidding-process.html>

**CITY AND COUNTY OF DENVER  
DEPARTMENT OF PUBLIC WORKS**

**BID FORM AND SUBMITTAL PACKAGE ACKNOWLEDGMENT**

**CONTRACT NO. 201843656**

**GENERAL SANITARY - CHERRY CREEK IMPROVEMENTS**

**BIDDER:** Insituform Technologies, LLC  
(Legal Name per Colorado Secretary of State)

**ADDRESS:** 17988 Edison Avenue  
Chesterfield, MO 63005  
   
 

The undersigned bidder states that the undersigned bidder has received and had an opportunity to fully and thoroughly examine a complete set of the Contract Documents for **Contract No. 201843656, GENERAL SANITARY - CHERRY CREEK IMPROVEMENTS**, made available to the undersigned bidder pursuant to Notice of Invitation for Bids dated August 1, 2018.

The undersigned bidder acknowledges that a complete and final set of the Contract Documents for the referenced Project, the components of which are identified below, are bound and maintained as the record set of Contract Documents by the Contract Administration Division of the Department of Public Works and that this Record Set is available for examination by the undersigned bidder.

The undersigned bidder, having thoroughly examined each of the components identified below and contained in Contract Documents, **HEREBY SUBMITS THIS BID FORM AND SUBMITTAL PACKAGE**, fully understanding that the Contract Documents, as defined in Paragraph 1 of the contract, including this executed Bid Form and Submittal Package, constitute all of the terms, conditions and requirements upon which this submission is based and further understanding that, by submission of this Bid Form and Submittal Package, the City shall rely on the representations and commitments of the undersigned bidder contained herein.

The following completed documents comprising this Bid Form and Submittal Package will be included with and, by this reference, are expressly incorporated into the Contract Documents specified at Paragraph 1 of the Contract:

- Bid Form and Submittal Package Acknowledgment Form
- Bid Form
- List of Proposed Minority/Woman Owned Business Enterprise(s)
- Commitment to Minority/Woman Owned Business Enterprise Participation
- Minority/Woman Owned Business Enterprise(s) of Intent
- Joint Venture Affidavit (if applicable)
- Joint Venture Eligibility Form (if applicable)
- Bid Bond
- Certificate of Insurance



The following designated documents constitute that portion of the Contract Documents made available by the Notice of Invitation for Bids, but not included in the Bid Form and Submittal Package:

Notice of Invitation for Bids  
Instructions to Bidders  
Addenda (as applicable)  
Equal Employment Opportunity Provisions (Appendix A and Appendix F)  
Contract Form  
General Contract Conditions  
Special Contract Conditions  
Performance and Payment Bond  
Notice to Apparent Low Bidder  
Notice to Proceed  
Contractor's Certification of Payment Form  
Final/Partial Lien Release Form  
Final Receipt  
Change Orders (as applicable)  
Federal Requirements (as applicable)  
Prevailing Wage Rate Schedule(s)  
Technical Specifications  
Contract Drawings  
Accepted Shop Drawings

The undersigned bidder expressly assumes responsibility for the complete contents of these designated documents as bound together with the Bid Form and Submittal Package submitted herewith and designated the Contract Documents.

IN WITNESS WHEREOF, the undersigned bidder has signed personally or by duly authorized officer or agent and duly attested.

**BIDDER:**

Name: Insituform Technologies, LLC

By: Whittany Schulte

Title: Whittany Schulte, Contracting & Attesting Officer

**ATTEST:**

By: Laura Andreski  
Laura Andreski, Contracting & Attesting Officer

[SEAL]

**CITY AND COUNTY OF DENVER  
DEPARTMENT OF PUBLIC WORKS**

**BID FORM**

**CONTRACT NO. 201843656  
GENERAL SANITARY - CHERRY CREEK IMPROVEMENTS**

**BIDDER** Insituform Technologies, LLC  
(Legal Name per Colorado Secretary of State)

**TO:** The Manager of Public Works  
City and County of Denver  
c/o Contract Administration  
201 West Colfax, Dept. 614  
Denver, Colorado 80202

The Undersigned Bidder, having examined the plans, technical specifications, and remainder of the proposed Contract Documents as designated and enumerated in the General and Special Contract Conditions and any and all addenda thereto; having investigated the location of and conditions affecting the proposed Work; and being acquainted with and fully understanding the extent and character of the Work covered by this bid, and all factors and conditions affecting or which may be affected by Work, **HEREBY SUBMITS THIS BID**, pursuant to an advertisement of a Notice of Invitation for Bids as published on **August 1, 2018**, to furnish all required materials, tools, appliances, equipment and plant; to perform all necessary labor and to undertake and complete: **CONTRACT NO. 201843656, GENERAL SANITARY - CHERRY CREEK IMPROVEMENTS**, in Denver, Colorado, in full accordance with and conformity to the Plans, Technical Specifications, and Contract Documents hereto attached or by reference made a part hereof, at and for the following price(s) set forth on this Bid Form.

The following documents, which taken as a whole constitute the Contract Documents for this Project, and which are incorporated herein, by reference, were made available to the Bidder as provided in the Advertisement of Notice of Invitation for Bids, were received by the bidder, and form the basis for this bid:

*Advertisement of Notice of Invitation for Bids*  
*Instructions to Bidders*  
*Commitment to M/WBE Participation*  
*Article III, Divisions 1 and 3 of Chapter 28, D.R.M.C.*  
*Bid Bond*  
*Addenda (as applicable)*  
*Equal Employment Opportunity Provisions (Appendix A and Appendix F)*  
*Bid Form*  
*Contract Form*  
*General Contract Conditions*  
*Special Contract Conditions*  
*Performance and Payment Bond*  
*Notice to Apparent Low Bidder*  
*Notice to Proceed*  
*Contractor's Certification of Payment Form*  
*Final/Partial Lien Release Form*  
*Final Receipt*  
*Change Orders (as applicable)*  
*Federal Requirements (as applicable)*  
*Prevailing Wage Rate Schedule(s)*  
*Technical Specifications*  
*Contract Drawing*  
*Accepted Shop Drawings*  
*Certificate of Insurance*

Item No.	Description and Price	Estimated Quantity	Estimated Cost
3-7a	<b>HEALTH &amp; SAFETY PLAN</b> at the unit price of \$ <u>5,000.00</u> per LUMP SUM.	1 LS	\$ <u>5,000.00</u>
3-7b	<b>MATERIAL MANAGEMENT PLAN</b> at the unit price of \$ <u>5,000.00</u> per LUMP SUM.	1 LS	\$ <u>5,000.00</u>
34-17.1a	<b>PRE-VIDEO INSPECTION OF 8" DIA. SEWER PIPE</b> at the unit price of \$ <u>1.60</u> per LINEAR FOOT.	64,796 LF	\$ <u>103,673.60</u>
34-17.1b	<b>PRE-VIDEO INSPECTION OF 10" DIA. SEWER PIPE</b> at the unit price of \$ <u>2.30</u> per LINEAR FOOT.	2,062 LF	\$ <u>4,742.60</u>
34-17.1c	<b>PRE-VIDEO INSPECTION OF 12" DIA. SEWER PIPE</b> at the unit price of \$ <u>2.20</u> per LINEAR FOOT.	3,105 LF	\$ <u>6,831.00</u>
34-17.1d	<b>PRE-VIDEO INSPECTION OF 15" DIA. SEWER PIPE</b> at the unit price of \$ <u>3.30</u> per LINEAR FOOT.	340 LF	\$ <u>1,122.00</u>
34-17.1e	<b>PRE-VIDEO INSPECTION OF 18" DIA. SEWER PIPE</b> at the unit price of \$ <u>6.40</u> per LINEAR FOOT.	120 LF	\$ <u>768.00</u>
34-17.1f	<b>PRE-VIDEO INSPECTION OF 21" DIA. SEWER PIPE</b> at the unit price of \$ <u>3.10</u> per LINEAR FOOT.	473 LF	\$ <u>1,466.30</u>
34-17.3c	<b>12" DIAMETER SANITARY SEWER BYPASS PUMPING</b> at the unit price of \$ <u>2.00</u> per LINEAR FOOT.	3,105 LF	\$ <u>6,210.00</u>
34.17.3d	<b>15" DIAMETER SANITARY SEWER BYPASS PUMPING</b> at the unit price of \$ <u>5.00</u> per LINEAR FOOT.	340 LF	\$ <u>1,700.00</u>
34.17.3e	<b>18" DIAMETER SANITARY SEWER BYPASS PUMPING</b> at the unit price of \$ <u>9.00</u> per LINEAR FOOT.	120 LF	\$ <u>1,080.00</u>

Item No.	Description and Price	Estimated Quantity	Estimated Cost
34.17.3f	<b>21" DIAMETER SANITARY SEWER BYPASS PUMPING</b> at the unit price of \$ <u>8.00</u> per LINEAR FOOT.	473 LF	\$ <u>3,784.00</u>
34-17.4a	<b>8" CURED-IN-PLACE PLASTIC LINER. Includes all necessary bypass pumping.</b> at the unit price of \$ <u>23.00</u> per LINEAR FOOT.	64,796 LF	\$ <u>1,490,308.00</u>
34.-17.4b	<b>10" CURED-IN-PLACE PLASTIC LINER. Includes all necessary bypass pumping.</b> at the unit price of \$ <u>39.00</u> per LINEAR FOOT.	2,062 LF	\$ <u>80,418.00</u>
34-17.4c	<b>12" CURED-IN-PLACE PLASTIC LINER</b> at the unit price of \$ <u>45.00</u> per LINEAR FOOT.	3,105 LF	\$ <u>139,725.00</u>
34.-17.4d	<b>15" CURED-IN-PLACE PLASTIC LINER</b> at the unit price of \$ <u>58.00</u> per LINEAR FOOT.	340 LF	\$ <u>19,720.00</u>
34-17.4e	<b>18" CURED-IN-PLACE PLASTIC LINER</b> at the unit price of \$ <u>133.00</u> per LINEAR FOOT.	120 LF	\$ <u>15,960.00</u>
34.-17.4f	<b>21" CURED-IN-PLACE PLASTIC LINER</b> at the unit price of \$ <u>107.00</u> per LINEAR FOOT.	473 LF	\$ <u>50,611.00</u>
34-17.5	<b>GRINDING (Assumed quantity)</b> at the unit price of \$ <u>1.00</u> per LINEAR FOOT.	3,000 LF	\$ <u>3,000.00</u>
34-17.6a	<b>SANITARY SEWER SERVICE REACTIVATION (CIPP) (Estimated tap amount)</b> at the unit price of \$ <u>25.00</u> per EACH.	3,000 EA	\$ <u>75,000.00</u>
34-17.7	<b>EXTENDED TAP CUTTING (Assumed quantity)</b> at the unit price of \$ <u>100.00</u> per EACH.	100 EA	\$ <u>10,000.00</u>

Item No.	Description and Price	Estimated Quantity	Estimated Cost
41-1	<b>TRAFFIC CONTROL</b> at the unit price of \$ <u>110,000.00</u> per LUMP SUM.	1 LS	\$ <u>110,000.00</u>
45-1	<b>CIPP LABORATORY TESTING</b> (Assumed quantity) at the unit price of \$ <u>640.00</u> per EACH.	20 EA	\$ <u>12,800.00</u>
50-1	<b>MOBILIZATION</b> at the unit price of \$ <u>35,000.00</u> per LUMP SUM.	1 LS	\$ <u>35,000.00</u>
01-55.26.01A	<b>TRAFFIC CONTROL. Uniform traffic control – assumed 10 days.</b> at the unit price of \$ <u>6,000.00</u> per ALLOWANCE ACCOUNT.	A/A	\$ <u>6,000.00</u>

25 ITEMS

**Bid Items 3-7a through 01-55.26.01A (Twenty-Five [25] total bid items) which includes one Allowance Account.**

\$ 2,189,919.50

**Textura ® Fee from table on Page BF-3 (based on Bid Items Total Amount)**

\$ 5,850.00

**Total Items Amount plus Textura® Fee equals Total Bid Amount**

\$ 2,195,769.50

**Total Bid Amount:**

Two million, One Hundred, Ninety-Five Thousand, Seven Hundred, Sixty-Nine Dollars and <sup>50</sup>/<sub>100</sub> —  
Dollars (\$ 2,195,769.50 )

If the Manager mails a written Notice of Apparent Low Bidder, addressed to the Bidder's business address stated on this Bid Form, the Undersigned Bidder shall, in accordance with the Contract Documents, be ready to, and shall, within five (5) days after the date of the Notice: (i) execute the attached form of Contract in conformity with this bid; (ii) furnish the required proofs of insurance; and (iii) furnish the required bond or bonds in the sum of the full amount of this bid, executed by a surety company acceptable to the Manager.

The Insituform Technologies, LLC, a ~~corporation~~ <sup>limited liability company</sup> of the State of Delaware, is hereby offered as Surety on said bond. If such surety is not approved by the Manager, another and satisfactory surety company shall be furnished.

Enclosed with this bid is a bid guarantee, as defined in the attached Instructions to Bidders, in the amount of 5% of amount bid. The Undersigned Bidder agrees that the entire amount of this bid guarantee is to be paid to and become the property of the City as liquidated damages, and not as a penalty, if: (i) the bid is considered to be the best by the City; (ii) the City notifies the Undersigned Bidder that it is the Apparent Low Bidder; and (iii) the Undersigned Bidder fails to execute the Contract in the form prescribed or to furnish the required bond and proofs of insurance, within five (5) days after the date of such notification.

The following persons, firms or corporations are interested with the Undersigned Bidder in this bid:

Name: \_\_\_\_\_ Name: \_\_\_\_\_

Address: \_\_\_\_\_ Address: \_\_\_\_\_

If there are no such persons, firms, or corporations, please so state in the following space:

No such persons, firms, or corporations with interest.

The Undersigned Bidder proposes to subcontract the following Work in accordance with General Contract Conditions, Title 5, SUBCONTRACTS, and represents that, to the greatest degree practical, all subcontractors known at the time of bid submittal have been identified.

Item of Work	Percent (%) of Total; Work	Proposed Subcontractor and Address
41-1	3.94%	Legacy Traffic Management 1390 S. Cherokee St, Denver, CO 80223
34-17.4a, b, c, d, e, f	4.57%	American Industrial + Const. Supply Inc 975 E. 58 <sup>th</sup> Ave Unit C Denver CO 80216
34-17.1a, b, c, d, e, f 34-17.5, 34-17.7	5.76%	Professional Pipe Services (Hoffman Southwest Corp) 6425 Washington St # 11 Denver, CO 80229

(Copy this page if additional room is required.)



**DENVER**  
OFFICE OF ECONOMIC  
DEVELOPMENT

**List of Proposed  
MWBE  
Bidders, Subcontractors,  
Suppliers (Manufacturers) or  
Brokers**

Office of Economic Development  
Division of Small Business Opportunity  
Compliance Unit  
201 W. Colfax Ave. Dept. 907  
Denver, CO 80202  
Phone: 720-913-1999  
[DSBO@denvergov.org](mailto:DSBO@denvergov.org)

City & County of Denver Contract No.: 201843656

The undersigned Bidder proposes to utilize all listed firms. The following MWBE(s) firms listed are CURRENTLY certified by the City and County of Denver. Only the level of MWBE participation listed at the bid opening will count toward satisfaction of the project goal. Only bona fide commissions may be counted for Brokers. MWBE prime bidders must detail their bid information below. Please copy and attach this page to list additional MWBE.

**Prime Bidder**

Business Name: Insituform Technologies, LLC  
Address: 17988 Edison Avenue, Chesterfield, MO 63005 Contact Person: Whitney Schulte, Contracting & Attesting Officer  
Type of Service: Cured-in-place pipe Dollar Amount: \$: \_\_\_\_\_ Percent of Project: \_\_\_\_\_

**Certified MWBE Prime Bidder**

Business Name: N/A  
Address: \_\_\_\_\_ Contact Person: \_\_\_\_\_  
Type of Service: \_\_\_\_\_ Dollar Amount: \$: \_\_\_\_\_ Percent of Project: \_\_\_\_\_

**Subcontractors, Suppliers Manufacturers or Brokers (check one box)**

Subcontractor (v)  Supplier (v)  Manufacturer (v)  Broker (v)

Business Name: Legacy Traffic Management  
Address: 1390 S. Cherokee St Denver, CO 80223 Type of Service: Traffic Control + Flagging  
Contact Person: Jesse Leonard Dollar Amount: \$: 810,254.00 Percent of Project: 3.94%  
 Subcontractor (v)  Supplier (v)  Manufacturer (v)  Broker (v)

Business Name: American Industrial + Const. Supply Inc  
Address: 975 E 58th Ave Unit C Denver, CO 80216 Type of Service: Resin Supplier  
Contact Person: Vinnie LeDoux Dollar Amount: \$: 100,000.00 Percent of Project: 4.57%  
 Subcontractor (v)  Supplier (v)  Manufacturer (v)  Broker (v)

Business Name: \_\_\_\_\_  
Address: \_\_\_\_\_ Type of Service: \_\_\_\_\_  
Contact Person: \_\_\_\_\_ Dollar Amount: \$: \_\_\_\_\_ Percent of Project: \_\_\_\_\_

Rev 031816JE



Subcontractors, Suppliers Manufacturers or Brokers (check one box)				
<input type="checkbox"/>	<input type="checkbox"/>	<input type="checkbox"/>	<input type="checkbox"/>	<input type="checkbox"/>
Subcontractor (✓)      Supplier (✓)      Manufacturer (✓)      Broker (✓)				
Business Name:				
Address:			Type of Service:	
Contact Person:			Dollar Amount: \$:	Percent of Project:
<input type="checkbox"/>	<input type="checkbox"/>	<input type="checkbox"/>	<input type="checkbox"/>	<input type="checkbox"/>
Subcontractor (✓)      Supplier (✓)      Manufacturer (✓)      Broker (✓)				
Business Name:				
Address:			Type of Service:	
Contact Person:			Dollar Amount: \$:	Percent of Project:
<input type="checkbox"/>	<input type="checkbox"/>	<input type="checkbox"/>	<input type="checkbox"/>	<input type="checkbox"/>
Subcontractor (✓)      Supplier (✓)      Manufacturer (✓)      Broker (✓)				
Business Name:				
Address:			Type of Service:	
Contact Person:			Dollar Amount: \$:	Percent of Project:
<input type="checkbox"/>	<input type="checkbox"/>	<input type="checkbox"/>	<input type="checkbox"/>	<input type="checkbox"/>
Subcontractor (✓)      Supplier (✓)      Manufacturer (✓)      Broker (✓)				
Business Name:				
Address:			Type of Service:	
Contact Person:			Dollar Amount: \$:	Percent of Project:
<input type="checkbox"/>	<input type="checkbox"/>	<input type="checkbox"/>	<input type="checkbox"/>	<input type="checkbox"/>
Subcontractor (✓)      Supplier (✓)      Manufacturer (✓)      Broker (✓)				
Business Name:				
Address:			Type of Service:	
Contact Person:			Dollar Amount: \$:	Percent of Project:
<input type="checkbox"/>	<input type="checkbox"/>	<input type="checkbox"/>	<input type="checkbox"/>	<input type="checkbox"/>
Subcontractor (✓)      Supplier (✓)      Manufacturer (✓)      Broker (✓)				
Business Name:				
Address:			Type of Service:	
Contact Person:			Dollar Amount: \$:	Percent of Project:
<input type="checkbox"/>	<input type="checkbox"/>	<input type="checkbox"/>	<input type="checkbox"/>	<input type="checkbox"/>
Subcontractor (✓)      Supplier (✓)      Manufacturer (✓)      Broker (✓)				

Rev 031816JE

The undersigned Bidder hereby certifies that the aforementioned subcontractors and suppliers have full knowledge that their names have been offered as subcontractors and suppliers for the work, and the Bidder further certifies that the dollar amount of work to be performed by the aforementioned M/WBE(s) was furnished to the Bidder prior to the bid opening. The undersigned Bidder agrees that after the bid opening, it shall submit to the City an executed and completed W/MBE "Letter of Intent" in three working days (3) on each of its M/WBE subcontractors. The "Letter of Intent" form is contained in the Contract Documents.

The undersigned Bidder acknowledges the right of the City to reject any or all bids submitted, to waive informalities in bids and to re-advertise this Project for bids.

The undersigned certifies that it has carefully checked all works and figures and all statements made in these Bid Forms.

This bid is submitted upon the declaration that neither, I (we), nor, to the best of my (our) knowledge, none of the members of my (our) firm or company have either directly or indirectly entered into any agreement, participated in any collusion or otherwise taken any action in restraint of free competitive bidding in connection with this bid.

Business Address of Bidder: 17988 Edison Avenue

City, State, Zip Code: Chesterfield, MO 63005

Telephone Number of Bidder: 636-530-8000 Fax No. 636-530-8701

Social Security or Federal Employer ID Number of Bidder: 13-3032158

Name and location of the last work of this kind herein contemplated upon which the Bidder was engaged:  
City of Arvada - Trenchless Sewer Main Replacement  
Term Contract

For information relative thereto, please refer to:

Name: Tim Hoos 720-898-7000 Thoos@arvada.gov

Title: Senior Utilities Design Engineer

Address: City of Arvada, 8101 Ralston Road, Arvada, CO 80001

The undersigned acknowledges receipt, understanding, and full consideration of the following addenda to the Contract Documents:

Addenda Number 1 Date August 17, 2018

Addenda Number \_\_\_\_\_ Date \_\_\_\_\_

Addenda Number \_\_\_\_\_ Date \_\_\_\_\_

Dated this 30 day of August, 2018.

**CITY AND COUNTY OF DENVER  
DEPARTMENT OF PUBLIC WORKS**

<b>CONTRACT NO: 201843656</b> <b>PROJECT NAME: General Sanitary – Cherry Creek East Improvements</b>
---

**ADDENDUM NO. 1 TO CONTRACT DOCUMENTS**

Bidders are hereby instructed that the drawings, specifications, and other contract documents are modified, corrected, supplemented and/or superseded for the above-mentioned project as hereinafter described in the following attachments:

This **ADDENDUM** shall be attached to, become a part of, and be returned with the Bid Proposal.

**QUESTIONS AND ANSWERS:**

- Q1.** Map Page 14: Please verify 439LF of 21" at Bayaud & Steele – MH23002 and MH22996? It looks more like 62LF in the parking ramp for Cherry Creek mall on google earth.
- A1.** *Pipe information is taken from the City's GIS data, which is a combination of as-built, design, and field data entry. We are aware that errors exist in this data set, but labeling utilizes the GIS data for consistency purposes. The physical length is 62 LF in GIS, but the plan set and cost estimate reflect 439 LF. Pay will be based on the field measurement. A table of GIS labels and associated main's physical length in GIS (CCE\_SAN\_IMPROVEMENTS-LABEL\_VS\_GIS\_LENGTH.PDF) are provided for your information.*
- Q2.** Map page #14: 1st & Steele intersection; could CCD provide a better satellite map location for MH22336 & MH43522?
- A2.** *A sketch of the aerial (Cherry Creek East Sanitary Lining – Steele Street Aerial.PDF) was provided at the Pre-bid and is appended to this Addendum.*
- Q3.** Are Cable Curing Temperature Sensors (i.e. thermal tape) required for the project?
- A3.** *Thermal Tape is required for mains that are 12" diameter and larger (4,038 LF based on the project's Summary of Quantities). Include this cost in cost for the CIPP Liner.*
- Q4.** Is UV-cured lining per ASTM F2019 allowed?
- A4.** *UV-cured lining is allowed for this project. A revised Specification for Section 10.7 is provided (SCS\_10\_07\_w\_UV.doc.pdf). Revisions and additional language from the Bid Set's Specifications are highlighted in yellow.*
- Q5.** Are hydrophilic seals required?
- A5.** *Hydrophilic seals are required at both ends of all lined mains at the manhole. Include this cost in cost for the CIPP Liner.*

**SPECIAL INSTRUCTIONS FOR BID:**

1 - The cost estimate includes an allowance account for Uniform Traffic Control for \$6,000, which is to be used for security purposes. 2 - Grinding is to be paid based on the lineal feet of physical grinding performed on the main, as measured in the field (not length of pipe or length up to and including grinding efforts). 3 - Coordinate with hotels and in-progress construction/developments to determine the best time to perform lining that minimizes impacts to their daily operations. Night and weekend work, as well as bypass pumping from the cleanout, may be necessary. 4 - Include by-pass pumping in the bid. Claims, as a result of not by-passing, are borne by the contractor.

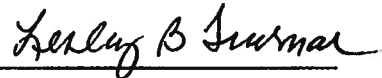

Lesley B. Thomas  
City Engineer

8.20.18

Date

The undersigned bidder acknowledges receipt of this Addendum. The Proposal submitted herewith is in accordance with the stipulations set forth herein.

Insituform Technologies, LLC

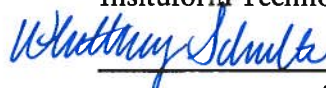

Contractor  
Whitney Schulte, Contracting & Attesting Officer

ADDENDUM NO. 1

August 17, 2018

Date

**Signature of Bidder:**

If an Individual: N/A doing business  
as \_\_\_\_\_.

If a Partnership: N/A  
by: \_\_\_\_\_ General Partner.

If a Corporation: Insituform Technologies, LLC  
a Limited Liability Company ~~Corporation~~,  
by: Whittney Schulte, its President.  
Whittney Schulte, Contracting & Attesting Officer

Attest:  
Laura Andreski  
~~Secretary~~ (Corporate Seal)  
Laura Andreski, Contracting & Attesting Officer

**If a Joint Venture, signature of all Joint Venture participants.**

Firm: N/A

Corporation ( ), Partnership ( ) or ( ) Limited Liability Company

By: \_\_\_\_\_ (If a Corporation)  
Attest: \_\_\_\_\_  
Title: \_\_\_\_\_ Secretary (Corporate Seal)

Firm: \_\_\_\_\_

Corporation ( ), Partnership ( ) or ( ) Limited Liability Company

By: \_\_\_\_\_ (If a Corporation)  
Attest: \_\_\_\_\_  
Title: \_\_\_\_\_ Secretary (Corporate Seal)

Firm: \_\_\_\_\_

Corporation ( ), Partnership ( ) or ( ) Limited Liability Company

By: \_\_\_\_\_ (If a Corporation)  
Attest: \_\_\_\_\_  
Title: \_\_\_\_\_ Secretary (Corporate Seal)



**COMMITMENT TO MWBE  
PARTICIPATION**

**The undersigned has satisfied the MWBE participant requirements in the following manner (Please check the appropriate box):**

The Bidder/Proposer is committed to the minimum 8.51 % MWBE utilization on the project, and will submit Letters of Intent (LOI) for each subcontractor/subconsultant listed in the Bid Forms as follows:  
**Hard Bids:** Three (3) business days after the bid opening.  
**Request for Proposals/Qualifications:** With the proposal when due.  
**Compliance Plans:** With each task/work order

The Bidder/Proposer is unable to meet the project goal of \_\_\_\_\_% MWBE, but is committed to a minimum of \_\_\_\_\_% MWBE utilization on the project. The Bidder/Proposer understands that they must submit a detailed statement of their good faith effort under sealed bid procedures, as a matter of responsiveness, or with initial proposals, under contract negotiation procedures; or no later than **three (3)** days after bid opening as a matter of responsibility as in accordance with DRMC Section 28-62 and 28-67 of Ordinance 85 to the Division of Small Business Opportunity.

The Bidder/Proposer is a certified MWBE in good standing with the City and is committed to self-perform a minimum of \_\_\_\_\_% of the work on the contract.

Bidder/Proposer (Name of Firm): Insituform Technologies, LLC

Firm's Representative (Please print): Whittney Schulte

Signature (Firm's Representative): *Whittney Schulte*

Title: Contracting & Attesting Officer

Address: 17988 Edison Avenue

City: Chesterfield

State: MO

Zip: 63005

Phone: 636-530-8000

Fax: 636-530-8701

Email: WSchulte@Aegion.com

**A copy of the MWBE Certification letter must be attached to each Letter of Intent (LOI).**



**DENVER**  
OFFICE OF ECONOMIC  
DEVELOPMENT

Office of Economic Development  
Division of Small Business Opportunity  
Compliance Unit  
201 West Colfax Ave., Dept. 907  
Denver, CO 80202  
Phone: 720-913-1099

**LETTER OF INTENT (LOI)**  
INSTRUCTIONS FOR COMPLETION & SUBMISSION:

- All lines must be completed or marked N/A for Not Applicable
- Certification Letter must be submitted with LOI
- Submit the attached completed checklist with this letter
- Email to [dobo@denvergov.org](mailto:dobo@denvergov.org).
- FOR RFPs and RFQs: LOIs should be included with Submittal

Contract No.: 201843656		Project Name: General Sanitary - Cherry Creek Improvements					
<b>A. The Following Section is To Be Completed by the Bidder/Consultant</b> <b>This Letter of Intent Must be Signed by the Bidder/Consultant and M/WBE, SBE, EBE or DBE</b>							
Name of Bidder/Consultant: Insituform Technologies, LLC				Self-Performing: <input checked="" type="checkbox"/> Yes <input checked="" type="checkbox"/> No		Phone: 636-530-8000	
Contact Person: Whitney Schulte, Contracting & Attesting Officer			Email: <a href="mailto:WSchulte@Aegion.com">WSchulte@Aegion.com</a>		Fax: 636-530-8701		
Address: 17988 Edison Avenue			City: Chesterfield		State: MO	Zip: 63005	
<b>B. The Following Section is To Be Completed by the M/WBE, SBE, EBE or DBE, at any Tier</b> <b>This Letter of Intent Must be Signed by the M/WBE, SBE, EBE or DBE and Bidder/Consultant</b>							
Name of Certified Firm: Legacy Traffic Management LLC				Phone: 720-296-2482			
Contact Person: Jesse Leonard		Email: <a href="mailto:jesse@legacytraffic.net">jesse@legacytraffic.net</a>		Fax: 720-726-6835			
Address: 1390 S. Cherokee St		City: Denver		State: CO	Zip: 80223		
Please check the designation which applies to the certified firm.			M/WBE (v) <input checked="" type="checkbox"/>	SBE (v) <input type="checkbox"/>	EBE (v) <input type="checkbox"/>	DBE (v) <input type="checkbox"/>	
Indirect Utilization: If this M/WBE, SBE, EBE or DBE is not a direct first tier subcontractor/subconsultant, supplier or broker to the Bidder/Consultant, please indicate the name of the subcontractor/subconsultant, supplier or broker which is utilizing the participation of this firm: N/A							
<b>A Copy of the M/WBE, SBE, EBE or DBE Letter of Certification must be Attached</b>							
Identify the scope of the work to be performed or supply item that will be provided by the M/WBE/SBE/DBE. <u>On unit price bids only. identify which bid line items the M/WBE/SBE/EBE/DBEs scope of work or supply corresponds to.</u>							
41-1 Traffic Control + Flagging Services							
<input checked="" type="checkbox"/>	Subcontractor/Subconsultant (v)		<input type="checkbox"/>			Supplier (v)	
<input type="checkbox"/>	Supplier (v)		<input type="checkbox"/>			Broker (v)	
Bidder intends to utilize the aforementioned M/WBE, SBE, EBE or DBE for the Work/Supply described above. The cost of the work and percentage of the total subcontractor M/WBE, SBE, EBE or DBE bid amount is:							
\$ 86,254.00				3.94 %			
Consultant intends to utilize the aforementioned M/WBE, SBE, EBE or DBE for the Work/Supply described above. The percentage of the work of the total subconsultant M/WBE, SBE, EBE or DBE will perform is:							
				N/A			
If the fee amount of the work to be performed is requested, the fee amount, is:							
				\$ N/A			
Bidder/Consultant's Signature: Whitney Schulte					Date: August 30, 2018		
Title: Whitney Schulte, Contracting & Attesting Officer							
M/WBE, SBE, EBE or DBE or Self-Performing Firm's Signature: Jesse Leonard					Date: 08/29/2018		
Title: Owner							
If the above named Bidder/Consultant is not determined to be the successful Bidder/Consultant, this Letter of Intent shall be null and void.							



**DENVER**  
OFFICE OF ECONOMIC  
DEVELOPMENT

Office of Economic Development  
Division of Small Business Opportunity  
Compliance Unit  
201 West Colfax Ave., Dept. 907  
Denver, CO 80202  
Phone: 720-913-1995

**LETTER OF INTENT (LOI)**  
INSTRUCTIONS FOR COMPLETION & SUBMISSION:

- All lines must be completed or marked N/A for Not Applicable
- Certification Letter must be submitted with LOI
- Submit the attached completed checklist with this letter
- Email to [dsbo@denvergov.org](mailto:dsbo@denvergov.org).
- FOR RFPs and RFQs: LOIs should be included with Submittal

Contract No.: 201843656		Project Name: General Sanitary - Cherry Creek Improvements	
<b>A. The Following Section Is To Be Completed by the Bidder/Consultant</b> <b>This Letter of Intent Must be Signed by the Bidder/Consultant and M/WBE, SBE, EBE or DBE</b>			
Name of Bidder/Consultant: Insituform Technologies, LLC		Self-Performing: <input checked="" type="checkbox"/> Yes <input checked="" type="checkbox"/> No	Phone: 636-530-8000
Contact Person: Whitney Schulte, Contracting & Attesting Officer		Email: <a href="mailto:WSchulte@Aegion.com">WSchulte@Aegion.com</a>	Fax: 636-530-8701
Address: 17988 Edison Avenue		City: Chesterfield	State: MO Zip: 63005
<b>B. The Following Section Is To Be Completed by the M/WBE, SBE, EBE or DBE, at any Tier</b> <b>This Letter of Intent Must be Signed by the M/WBE, SBE, EBE or DBE and Bidder/Consultant</b>			
Name of Certified Firm: <i>American Industrial + Const. Supply Inc</i>		Phone: <i>303-292-5424</i>	
Contact Person: <i>Vinnie Le Doux</i>		Email: <i>Vinnie@aiicscolorado.com</i>	Fax: <i>303-292-9036</i>
Address: <i>975 E. 58th Ave #2</i>		City: <i>Denver</i>	State: <i>CO</i> Zip: <i>80216</i>
Please check the designation which applies to the certified firm.		M/WBE (✓) <input checked="" type="checkbox"/>	SBE (✓) <input checked="" type="checkbox"/>
		EBE (✓) <input checked="" type="checkbox"/>	DBE (✓) <input checked="" type="checkbox"/>
Indirect Utilization: If this M/WBE, SBE, EBE or DBE is not a direct first tier subcontractor/subconsultant, supplier or broker to the Bidder/Consultant, please indicate the name of the subcontractor/subconsultant, supplier or broker which is utilizing the participation of this firm: <i>N/A</i>			
<b>A Copy of the M/WBE, SBE, EBE or DBE Letter of Certification must be Attached</b>			
Identify the scope of the work to be performed or supply item that will be provided by the M/WBE/SBE/DBE. <u>On unit price bids only, identify which bid line items the M/WBE/SBE/EBE/DBEs scope of work or supply corresponds to.</u>			
<i>34-17.4a, 34-17.4b, 34-17.4c, 34-17.4d, 34-17.4e, 34-17.4f</i>			
<i>Resin Supplier</i>			
Subcontractor/Subconsultant (✓) <input checked="" type="checkbox"/>		Supplier (✓) <input checked="" type="checkbox"/>	Broker (✓) <input type="checkbox"/>
Bidder intends to utilize the aforementioned M/WBE, SBE, EBE or DBE for the Work/Supply described above. The cost of the work and percentage of the total subcontractor M/WBE, SBE, EBE or DBE bid amount is:			
\$ <i>100,000.00</i>		<i>4.57%</i>	
Consultant intends to utilize the aforementioned M/WBE, SBE, EBE or DBE for the Work/Supply described above. The percentage of the work of the total sub consultant M/WBE, SBE, EBE or DBE will perform is:			
		<i>N/A</i>	
If the fee amount of the work to be performed is requested, the fee amount, is:			
		\$ <i>N/A</i>	
Bidder/Consultant's Signature: <i>Whitney Schulte</i>		Date: August 30, 2018	
Title: Whitney Schulte, Contracting & Attesting Officer			
M/WBE, SBE, EBE or DBE or Self-Performing Firm's Signature: <i>[Signature]</i>		Date: <i>8/29/18</i>	
Title: <i>[Signature]</i>			
If the above named Bidder/Consultant is not determined to be the successful Bidder/Consultant, this Letter of Intent shall be null and void.			



Bid Date 8.30.18

**Letter of Intent (LOI) Checklist**

All lines must be completed or marked N/A for Not Applicable

Submit the attached completed checklist with this letter.

<b>Completed</b> ✓	Denver General Sanitary Cherry Creek Improvements Insituform Technologies, LLC # 201843656
<input checked="" type="checkbox"/>	Project Number & Project Name
<input checked="" type="checkbox"/>	Section A: Name of Bidder/Consultant, Contact Person, Address, City, State, Zip, Phone, Email
<input checked="" type="checkbox"/>	Section B: Name of Certified Firm, Contact Person, Address, City, State, Zip, Phone, Email
<input checked="" type="checkbox"/>	Designation checked for MBE/WBE, SBE, EBE or DBE
<input checked="" type="checkbox"/>	Indirect Utilization: Name of subcontractor/subconsultant, supplier or broker is indicated if using the participation of a 2 <sup>nd</sup> tier subcontractor/subconsultant, supplier or broker.
<input checked="" type="checkbox"/>	Scope of work performed or item supplied by M/WBE, SBE, EBE or DBE
<input checked="" type="checkbox"/>	Line items performed, if line-item bid.
<input checked="" type="checkbox"/>	Copy of M/WBE, SBE, EBE or DBE Letter of Certification Attached
<input type="checkbox"/>	Designation checked for Subcontractor/Subconsultant, Supplier or Broker
	<b>If project is a hard bid...</b>
<input checked="" type="checkbox"/>	Bidder has indicated dollar amount for value of work going to Subcontractor/ Subconsultant, Supplier or Broker
<input checked="" type="checkbox"/>	Bidder has indicated percentage for value of work going to Subcontractor/ Subconsultant, Supplier or Broker
	<b>If project is an RFP/RFQ...</b> N/A
<input type="checkbox"/>	Consultant has indicated percentage for value of work going to Subcontractor/ Subconsultant, Supplier or Broker Name & contact name for MWBE.
<input type="checkbox"/>	Fee amount if fee amount of work to be performed is requested.
<input checked="" type="checkbox"/>	Bidder/Consultant's Signature, Title & Date
<input type="checkbox"/>	M/WBE, SBE, EBE or DBE Firm's Signature, Title and Date

<b>Select One</b> ✓	<b>SUBMITTED VIA...</b> For Construction Hard Bids ONLY, Bidders are strongly urged to deliver the LOI via one of the methods below. (The preferred method is to scan/email completed forms to email address below. Delivery to any other point cannot be guaranteed timely delivery.)
<input type="checkbox"/>	Email to DSBO@denvergov.org

The complete and accurate information that is required for the Letter of Intent is based on the following sections of the Ordinance 85: Section 28-63 and Section 28-68. Failure to complete this information on the Letter of Intent (LOI) may automatically deem a bid or proposal non-responsive.



**DENVER**  
OFFICE OF ECONOMIC  
DEVELOPMENT

### Joint Venture Affidavit

Office of Economic Development  
Division of Small Business Opportunity  
Compliance Unit  
201 W. Colfax Ave. Dept. 907  
Denver, CO 80202  
Phone: 720-913-1999  
[DSBO@denvergov.org](mailto:DSBO@denvergov.org)

The Undersigned swears that the foregoing statements are correct and include all material information necessary to identify and explain the terms and operation of our joint venture and the intended participation by each joint venturer in the undertaking. Further, the Undersigned covenant and agree to provide the City current, complete, and accurate information regarding actual joint venture work and the payment thereof and any proposed changes in any of the joint venture arrangements and to permit the audit and examination of the books, records, and files of the joint venture, by authorized representatives of the City or Federal funding agency, if applicable. Any material misrepresentation will be grounds for terminating any contract which may be awarded and for initiating action under Federal or State laws concerning false statements.

Name of Firm: \_\_\_\_\_

Print Name: \_\_\_\_\_

Title \_\_\_\_\_

Signature: \_\_\_\_\_

Date: \_\_\_\_\_

#### Notary Public

County of \_\_\_\_\_

State of \_\_\_\_\_

My Commission Expires: \_\_\_\_\_

Subscribed and sworn before me this

\_\_\_\_\_ day of \_\_\_\_\_, 20\_\_\_\_

Notary Seal

Notary Signature: \_\_\_\_\_

Notary Commission #: \_\_\_\_\_

Address: \_\_\_\_\_

Name of Firm: \_\_\_\_\_

Print Name: \_\_\_\_\_

Title \_\_\_\_\_

Signature: \_\_\_\_\_

Date: \_\_\_\_\_

#### Notary Public

County of \_\_\_\_\_

State of \_\_\_\_\_

My Commission Expires: \_\_\_\_\_

Subscribed and sworn before me this

\_\_\_\_\_ day of \_\_\_\_\_, 20\_\_\_\_

Notary Seal

Notary Signature: \_\_\_\_\_

Notary Commission #: \_\_\_\_\_

Address: \_\_\_\_\_

 <p><b>DENVER</b> OFFICE OF ECONOMIC DEVELOPMENT</p>	<p><b>JOINT VENTURE ELIGIBILITY FORM</b></p>	<p>Office of Economic Development Division of Small Business Opportunity Compliance Unit 201 W. Colfax Ave. Dept. 907 Denver, CO 80202 Phone: 720-913-1999 <a href="mailto:DSBO@denvergov.org">DSBO@denvergov.org</a></p>
<p><b>Joint Venture means an association of two (2) or more business enterprises to constitute a single business enterprise to perform a City construction or professional design and construction services contract for which purpose they combine their property, capital, efforts, skills and knowledge, and in which each joint venturer is responsible for a distinct, clearly defined portion of the work of the contract, performs a commercially useful function, and whose share in the capital contribution, control, management responsibilities, risks and profits of the joint venture are equal to its ownership interest. Joint ventures must have an agreement in writing specifying the terms and conditions of the relationships between the joint venturers and their relationship and responsibility to the contract.</b></p> <p>The Division of Small Business Opportunity (DSBO) requires the following information be provided from participants of a prospective joint venture, to assist DSBO in evaluating the proposed joint venture. This Joint Venture Eligibility form and the Joint Venture Affidavit apply if SBEs, EBEs, MBEs, WBEs or DBEs participate in this joint venture.</p> <p>Please return this form, the Joint Venture Affidavit, and a copy of your Joint Venture Agreement to: Division of Small Business Opportunity, 201 West Colfax Avenue, Denver, CO 80202, at least ten (10) working days prior to bid opening or proposal.</p> <p>If you have questions regarding this process, please contact DSBO at 720-913-1999.</p>		
<b>Joint Venture Information</b>		
Name:		Contact Person:
Address:		
City:	State:	Zip: Phone:
<b>Joint Venture Participants</b>		
Name:		Contact Person:
Address:		
City:	State:	Zip: Phone:
% Ownership:	Certifying Entity:	Type Certification & Date: (S/E/M/W or DBE)
Type of Work for which Certification was granted:		
Name:		Contact Person:
Address:		
City:	State:	Zip: Phone:
% Ownership:	Certifying Entity:	Type Certification & Date: (S/E/M/W or DBE)
Type of Work for which Certification was granted:		
<b>General Information</b>		
SBE/EBE/MBE/WBE/DBE Initial Capital Contributions: \$		%
Future capital contributions (explain requirements) (attach additional sheets if necessary):		
Source of Funds for the SBE/EBE/MBE/WBE/DBE Capital Contributions:		
Describe the portion of the work or elements of the business controlled by the SBE/EBE/MBE/WBE or DBE: (attach additional sheets if necessary)		

Not Applicable

<b>Describe the portion of the work or elements of the business controlled by non-SBE/EBE/MBE/WBE or DBE: (attach additional sheets if necessary)</b>
<b>JOINT VENTURE ELIGIBILITY FORM</b>
<b>General information</b>
<b>Describe the SBE/EBE/MBE/WBE or DBE's involvement in the overall management of the joint venture (e.g., participation on a management committee or managing board voting rights, etc.) (attach additional sheets if necessary)</b>
<b>Describe the SBE/EBE/MBE/WBE or DBE's share in the profits of the joint venture:</b>
<b>Describe the SBE/EBE/MBE/WBE or DBE's share in the risks of the joint venture:</b>
<b>Describe the roles and responsibilities of each joint venture participant with respect to managing the joint venture (use additional sheets if necessary):</b>
<b>a. SBE/EBE/MBE/WBE or DBE joint venture participant:</b>
<b>b. Non- SBE/EBE/MBE/WBE or DBE joint venture participant:</b>
<b>Describe the roles and responsibilities of each joint venture participant with respect to operation of the joint venture (use additional sheets if necessary):</b>
<b>a. SBE/EBE/MBE/WBE or DBE joint venture participant:</b>
<b>b. Non- SBE/EBE/MBE/WBE or DBE joint venture participant:</b>

Not Applicable

Which firm will be responsible for accounting functions relative to the joint venture's business?			
Explain what authority each party will have to commit or obligate the other to insurance and bonding companies, financing institutions, suppliers, subcontractors, and/or other parties?			
Please provide information relating to the approximate <b>number</b> of management, administrative, support and non-management employees that will be required to operate the business and indicate whether they will be employees of the S/E/MWBE/DBE, non- S/E/MWBE/DBE or joint venture:			
	<b>Non- SBE/EBE/MWBE/DBE</b>	<b>SBE/EBE/MWBE/DBE</b>	<b>Joint Venture</b>
<b>Management</b>			
<b>Administrative</b>			
<b>Support</b>			
<b>Hourly Employees</b>			
<b>JOINT VENTURE ELIGIBILITY FORM</b>			
<b>General Information</b>			
Please provide the name of the person who will be responsible for hiring employees for the joint venture.			
Who will they be employed by?			
Are any of the proposed joint venture employees currently employees of any of the joint venture partners?			
	<input type="checkbox"/>	Yes (✓)	<input type="checkbox"/>
	<input type="checkbox"/>	No (✓)	
If yes, please list the number and positions and indicate which firm currently employs the individual(s). (use additional sheets if necessary)			
<b>Number of employees</b>		<b>Position</b>	<b>Employed By</b>
<b>Attach a copy of the proposed joint venture agreement, promissory note or loan agreement (if applicable), and any and all written agreements between the joint venture partners.</b>			
List all other business relationships between the joint venture participants, including other joint venture agreements in which the parties are jointly involved.			
If there are any significant changes in or pertaining to this submittal, the joint venture members must immediately notify the Division of Small Business Opportunity.			

COMP-FRM-015

**CITY AND COUNTY OF DENVER  
DEPARTMENT OF PUBLIC WORKS**

**BID BOND**

KNOW ALL MEN BY THESE PRESENTS:

THAT **Insituform Technologies, LLC, 17988 Edison Avenue, Chesterfield, MO 63005**, as Principal, and **Travelers Casualty and Surety Company of America, One Tower Square, Hartford, CT 06183** a corporation organized and existing under and by virtue of the laws of the State of **Connecticut**, and authorized to do business within the State of Colorado, as Surety, are held and firmly bound unto the City and County of Denver, Colorado, as Obligees, in full and just sum of **Five Percent of the Amount Bid** Dollars, (**\$ 5% Amt. Bid**), lawful money of the United States, for the payment of which sum, well and truly to be made, we bind ourselves, our heirs, executors, administrators, successors and assigns, jointly and severally, firmly by these presents:

WHEREAS, the said Principal is herewith submitting its bid, dated **August 30**, 20**18** for the construction of: **Contract No. 201843656, GENERAL SANITARY - CHERRY CREEK IMPROVEMENTS**, as set forth in detail in the Contract Documents for the City and County of Denver, Colorado, and said Obligees has required as a condition for receiving said bid that the Principal deposit specified bid security in the amount of not less than five percent (5%) of the amount of said bid, as it relates to work to be performed for the City, conditioned that in event of failure of the Principal to execute the Contract, for such construction and furnish required Performance and Payment Bond if the contract is offered him that said sum be paid immediately to the Obligees as liquidated damages, and not as a penalty, for the Principal's failure to perform.

The condition of this obligation is such that if the aforesaid Principal shall, within the period specified therefore, on the prescribed form presented to him for signature, enter into a written contract with the Obligees in accordance with his bid as accepted and give Performance and Payment Bond with good and sufficient surety or sureties, upon the form prescribed by the Obligees, for the faithful performance and the proper fulfillment of said Contract, or in the event of withdrawal of said bid within the time specified, or upon the payment to the Obligees of the sum determined upon herein, as liquidated damages and not as penalty, in the event the Principal fails to enter into said contract and give such Performance and Payment Bond within the time specified, then this Obligation shall be null and void, otherwise to remain in full force and effect.

Signed, sealed and delivered this 30 day of August, 2018.

ATTEST

  
Secretary **Diane Partridge**  
Contracting & Attesting Officer

**Insituform Technologies, LLC**

Principal

By

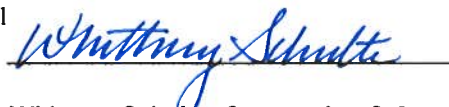

Title

**Whitney Schulte, Contracting & Attesting Officer**

Surety

By

**Travelers Casualty and Surety Company of America**  
  
**Amanda L. Williams, Attorney-in-Fact**

[SEAL]

Seal if Bidder is Corporation  
(Attach Power-of-Attorney)

State of Missouri  
County of St. Louis

On 8/30/2018, before me, a Notary Public in and for said County and State, residing therein, duly commissioned and sworn, personally appeared Amanda L. Williams known to me to be Attorney-in-Fact of

## TRAVELERS CASUALTY AND SURETY COMPANY OF AMERICA

the corporation described in and that executed the within and foregoing instrument, and known to me to be the person who executed the said instrument in behalf of said corporation, and he duly acknowledged to me that such corporation executed the same.

IN WITNESS WHEREOF, I have hereunto set my hand and affixed my official seal, the day and year stated in this certificate above.

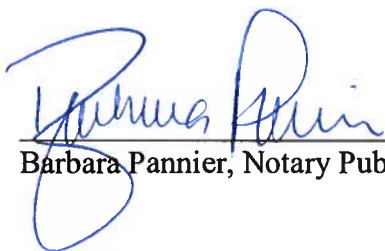
  
\_\_\_\_\_  
Barbara Pannier, Notary Public

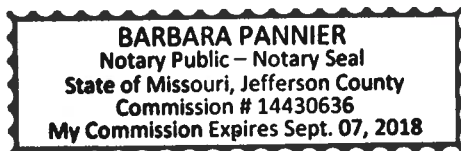

My Commission Expires: \_\_\_\_\_



**Travelers Casualty and Surety Company of America  
Travelers Casualty and Surety Company  
St. Paul Fire and Marine Insurance Company**

**POWER OF ATTORNEY**

**KNOW ALL MEN BY THESE PRESENTS:** That Travelers Casualty and Surety Company of America, Travelers Casualty and Surety Company, and St. Paul Fire and Marine Insurance Company are corporations duly organized under the laws of the State of Connecticut (herein collectively called the "Companies"), and that the Companies do hereby make, constitute and appoint **Amanda L. Williams**, of **Chesterfield, Missouri**, their true and lawful Attorney-in-Fact to sign, execute, seal and acknowledge any and all bonds, recognizances, conditional undertakings and other writings obligatory in the nature thereof on behalf of the Companies in their business of guaranteeing the fidelity of persons, guaranteeing the performance of contracts and executing or guaranteeing bonds and undertakings required or permitted in any actions or proceedings allowed by law.

**IN WITNESS WHEREOF**, the Companies have caused this instrument to be signed, and their corporate seals to be hereto affixed, this **3rd day of February, 2017**.



State of Connecticut

City of Hartford ss.

By: *Robert L. Raney*  
Robert L. Raney, Senior Vice President

On this the **3rd day of February, 2017**, before me personally appeared **Robert L. Raney**, who acknowledged himself to be the Senior Vice President of Travelers Casualty and Surety Company of America, Travelers Casualty and Surety Company, and St. Paul Fire and Marine Insurance Company, and that he, as such, being authorized so to do, executed the foregoing instrument for the purposes therein contained by signing on behalf of the corporations by himself as a duly authorized officer.

**In Witness Whereof**, I hereunto set my hand and official seal.

My Commission expires the **30th day of June, 2021**



*Marie C. Tetreault*  
Marie C. Tetreault, Notary Public

This Power of Attorney is granted under and by the authority of the following resolutions adopted by the Boards of Directors of Travelers Casualty and Surety Company of America, Travelers Casualty and Surety Company, and St. Paul Fire and Marine Insurance Company, which resolutions are now in full force and effect, reading as follows:

**RESOLVED**, that the Chairman, the President, any Vice Chairman, any Executive Vice President, any Senior Vice President, any Vice President, any Second Vice President, the Treasurer, any Assistant Treasurer, the Corporate Secretary or any Assistant Secretary may appoint Attorneys-in-Fact and Agents to act for and on behalf of the Company and may give such appointee such authority as his or her certificate of authority may prescribe to sign with the Company's name and seal with the Company's seal bonds, recognizances, contracts of indemnity, and other writings obligatory in the nature of a bond, recognizance, or conditional undertaking, and any of said officers or the Board of Directors at any time may remove any such appointee and revoke the power given him or her; and it is

**FURTHER RESOLVED**, that the Chairman, the President, any Vice Chairman, any Executive Vice President, any Senior Vice President or any Vice President may delegate all or any part of the foregoing authority to one or more officers or employees of this Company, provided that each such delegation is in writing and a copy thereof is filed in the office of the Secretary; and it is

**FURTHER RESOLVED**, that any bond, recognizance, contract of indemnity, or writing obligatory in the nature of a bond, recognizance, or conditional undertaking shall be valid and binding upon the Company when (a) signed by the President, any Vice Chairman, any Executive Vice President, any Senior Vice President or any Vice President, any Second Vice President, the Treasurer, any Assistant Treasurer, the Corporate Secretary or any Assistant Secretary and duly attested and sealed with the Company's seal by a Secretary or Assistant Secretary; or (b) duly executed (under seal, if required) by one or more Attorneys-in-Fact and Agents pursuant to the power prescribed in his or her certificate or their certificates of authority or by one or more Company officers pursuant to a written delegation of authority; and it is

**FURTHER RESOLVED**, that the signature of each of the following officers: President, any Executive Vice President, any Senior Vice President, any Vice President, any Assistant Vice President, any Secretary, any Assistant Secretary, and the seal of the Company may be affixed by facsimile to any Power of Attorney or to any certificate relating thereto appointing Resident Vice Presidents, Resident Assistant Secretaries or Attorneys-in-Fact for purposes only of executing and attesting bonds and undertakings and other writings obligatory in the nature thereof, and any such Power of Attorney or certificate bearing such facsimile signature or facsimile seal shall be valid and binding upon the Company and any such power so executed and certified by such facsimile signature and facsimile seal shall be valid and binding on the Company in the future with respect to any bond or understanding to which it is attached.

I, **Kevin E. Hughes**, the undersigned, Assistant Secretary of Travelers Casualty and Surety Company of America, Travelers Casualty and Surety Company, and St. Paul Fire and Marine Insurance Company, do hereby certify that the above and foregoing is a true and correct copy of the Power of Attorney executed by said Companies, which remains in full force and effect.

Dated this **30** day of **August**, 2018



*Kevin E. Hughes*  
Kevin E. Hughes, Assistant Secretary

**To verify the authenticity of this Power of Attorney, please call us at 1-800-421-3880.  
Please refer to the above-named Attorney-in-Fact and the details of the bond to which the power is attached.**





Office of Economic Development  
 Division of Small Business Opportunity  
 201 W. Colfax Ave, Dept. 907  
 Denver, CO 80202  
 p: 720.913.1999  
 f: 720.913.1809  
[www.denvergov.org/dsbo](http://www.denvergov.org/dsbo)

## Diversity and Inclusiveness \* in City Solicitations Information Request Form

Type in your response, print out, sign and date; or print out and complete manually. Please print legibly.

Denver Executive Order No. 101 establishes strategies between the City and private industry to use diversity and inclusiveness to promote economic development in the City and County of Denver and to encourage more businesses to compete for City contracts and procurements. The Executive Order requires, among other things, the collection of certain information regarding the practices of the City's contractors and consultants toward diversity and inclusiveness and encourages/requires City agencies to include diversity and inclusiveness policies in selection criteria where legally permitted in solicitations for City services or goods.

Answer each question below. Missing or incomplete responses will be recorded as "no", "not applicable", or "none". A proposal or response to a solicitation by a contractor/consultant that does not include this completed form shall be deemed non-responsive and rejected.

Business Email Address: WSchulte@Aegion.com

Please include the Email address of the contact person facilitating this solicitation for the City and County of Denver: WSchulte@Aegion.com

Agency Name:

- |   |  |  |
|---|--|--|
| <input type="checkbox"/> Arts and Venue               | <input type="checkbox"/> Purchasing Division     | <input type="checkbox"/> Sheriff Department  |
| <input type="checkbox"/> Auditor Office               | <input type="checkbox"/> Human Services          | <input type="checkbox"/> Technology Services |
| <input type="checkbox"/> Community Planning           | <input type="checkbox"/> Economic Development    | <input type="checkbox"/> Other               |
| <input type="checkbox"/> Denver International Airport | <input type="checkbox"/> Parks and Recreation    |  |
| <input type="checkbox"/> Environmental Health         | <input type="checkbox"/> Police Department       |  |
| <input type="checkbox"/> Fire Department              | <input checked="" type="checkbox"/> Public Works |  |

Project Name: General Sewer - Cherry Creek Improvements

BID / RFP No.: 201843656

Name of Contractor/Consultant: Insituform Technologies, LLC

What industry is your business? General Construction Contracting

Address:

17988 Edison Avenue  
Chesterfield, MO 63005

Business Phone No.: 636-530-8000

Business Facsimile No.: 636-530-8701

OED – Executive Order No. 101  
 Diversity and Inclusiveness in City Solicitations Information Request Form  
 Rev. 12/29/2015

1. How many employees does your company employ?

- 1-10                       51-100  
 11-50                       over 100

1.1. How many of your company's employees are:

Full-time 725                      Part-Time \_\_\_\_\_

2. Do you have a Diversity and Inclusiveness Program?  Yes                       No

If No, and your company size is less than 10 employees continue to question 11. Complete and sign the form.

If Yes, does it address:

- 2.1 Employment and retention?                       Yes                       No  
2.2 Procurement and supply chain activities?                       Yes                       No  
2.3 Customer service?                       Yes                       No

3. Provide a detailed narrative of your company's diversity and inclusiveness principles and programs. This may include, for example, (i) diversity and inclusiveness employee training programs, equal opportunity policies, and the budget amount spent on an annual basis for workplace diversity; or (ii) diversity and inclusiveness training and information to improve customer service.

Written EEO and Affirmative Action Policies

4. Does your company regularly communicate its diversity and inclusiveness policies to employees?

If Yes, how does your company regularly communicate its diversity and Inclusiveness policies to employees? (select all that apply)

- Employee Training  
 Pamphlets  
 Public EEO postings  
 Other  
 Not Applicable

5. If you responded that you do not have a diversity and inclusiveness program, describe any plans your company may have to adopt such a program.

N/A

6. How often do you provide training in diversity and inclusiveness principles?

- Monthly                       Annually  
 Quarterly                       Not Applicable                       Other \_\_\_\_\_

6.1 What percentage of the total number of employees generally participate?

- 0 - 25%                       51 - 75%  
 26 - 50%                       76 - 100%                       Not Applicable

7. State how you achieve diversity and inclusiveness in supply and procurement activities. This may include, for example, narratives of training programs, equal opportunity policies, diversity or inclusiveness partnership programs, mentoring and outreach programs, and the amount and description of budget spent on an annual basis for procurement and supplier diversity and inclusiveness.

Written EEO and Affirmative Action Policies

8. Do you have a diversity and inclusiveness committee?  Yes     No

8.1 If Yes, how often does it meet?

- Monthly                       Annually                       No Committee  
 Quarterly                       Other \_\_\_\_\_

8.2 If you responded that you do not have a diversity and inclusiveness committee, describe any plans your company may have to establish such a committee.

N/A

9. Do you have a budget for diversity and inclusiveness efforts?  Yes  No

10. Does your company integrate diversity and inclusion competencies into executive/manager performance evaluation plans?  Yes  No

11. Would you like information detailing how to implement a Diversity and Inclusiveness program?  
 Yes  No

If yes, please email [X0101@denvergov.org](mailto:X0101@denvergov.org).

I attest that the information represented herein is true, correct and complete, to the best of my knowledge.

  
Signature of Person Completing Form

August 30, 2018  
Date

Whittney Schulte, Contracting & Attesting Officer  
Printed Name of Person Completing Form

**NOTE: Attach additional sheets or documentation as necessary for a complete response.**

\*"Diversity and inclusiveness program" means a program that invites values, perspectives and contributions of people from diverse backgrounds, and integrates diversity into its hiring and retention policies, training opportunities, and business development methods to provide an equal opportunity for each person to participate, contribute, and succeed within the organization's workplace. "Diversity" encompasses a wide variety of human differences, including differences such as race, age, gender, gender identity, sexual orientation, ethnicity, physical disabilities, appearance, historically underutilized and disadvantaged persons, as well as social identities such as religion, marital status, socio-economic status, lifestyle, education, parental status, geographic background, language ability, and veteran status."

CITY AND COUNTY OF DENVER

STATE OF COLORADO



**DENVER**  
THE MILE HIGH CITY

DEPARTMENT OF PUBLIC WORKS

Bid Documents Package

Contract Number: 201843656



General Sanitary – Cherry Creek Improvements

August 1, 2018

**CITY AND COUNTY OF DENVER**  
**DEPARTMENT OF PUBLIC WORKS**

**TABLE OF CONTENTS FOR CONTRACT DOCUMENTS**

<b>BID FORM AND SUBMITTAL PACKAGE</b>	<b><u>PAGE</u></b>
Bid Form and Submittal Package (bound separately and attached as part of these Bid Documents)	
Table of Contents	BF-1
Bidder's Checklist	BF-2 through BF-3
Bid Form and Submittal Package Acknowledgment Form	BF-4 through BF-5
Bid Form	BF-6 through BF-8
List of Proposed Minority and Woman Business Enterprise(s)	BF-9 through BF-12
Commitment to Minority and Woman Business Enterprise Participation	BF-13
Minority and Woman Business Enterprise Letter(s) of Intent & Checklist	BF-14 through BF-15
Joint Venture Affidavit	BF-16
Joint Venture Eligibility Form	BF-17 through BF-19
Bid Bond	BF-20
Diversity and Inclusiveness in City Solicitations Form	BF-21 through BF-24
<b>BID DOCUMENTS</b>	
Table of Contents	BDP-1
Statement of Quantities	SQ-1 through SQ-2
Notice of Invitation for Bids	BDP-2 through BDP-3
Instructions to Bidders	BDP-4 through BDP-15
Equal Employment Opportunity Provisions	BDP-16 through BDP-25
Appendix A	
Appendix F	
Contract Form	BDP-26 through BDP-30
Index of the General Contract Conditions	BDP-31 through BDP-35
Special Contract Conditions	BDP-36 through BDP-44
Final/Partial Release and Certificate of Payment Forms (Samples)	BDP-39 through BDP-41
Performance and Payment Bond Form	BDP-45 through BDP-46
Performance and Payment Bond Surety Authorization letter (Sample)	BDP - 47
Notice to Apparent Low Bidder (Sample)	BDP-48 through BDP-49
Notice To Proceed (Sample)	BDP-50
Certificate of Contract Release (Sample)	BDP-51
Prevailing Wage Rate Schedule	6 pages
Technical Specifications	307 pages
Contract Drawings	32 pages



**STATEMENT OF QUANTITIES**

<u>Item No.</u>	<u>Description</u>	<u>Estimated</u>	<u>Quantity</u>
3-7a	HEALTH & SAFETY PLAN	1	LS
3-7b	MATERIAL MANAGEMENT PLAN	1	LS
34-17.1a	PRE-VIDEO INSPECTION OF 8" DIA. SEWER PIPE	64,796	LF
34-17.1b	PRE-VIDEO INSPECTION OF 10" DIA. SEWER PIPE	2,062	LF
34-17.1c	PRE-VIDEO INSPECTION OF 12" DIA. SEWER PIPE	3,105	LF
34-17.1d	PRE-VIDEO INSPECTION OF 15" DIA. SEWER PIPE	340	LF
34-17.1e	PRE-VIDEO INSPECTION OF 18" DIA. SEWER PIPE	120	LF
34-17.1f	PRE-VIDEO INSPECTION OF 21" DIA. SEWER PIPE	473	LF
34-17.3c	12" DIAMETER SANITARY SEWER BYPASS PUMPING	3,105	LF
34.17.3d	15" DIAMETER SANITARY SEWER BYPASS PUMPING	340	LF
34.17.3e	18" DIAMETER SANITARY SEWER BYPASS PUMPING	120	LF
34.17.3f	21" DIAMETER SANITARY SEWER BYPASS PUMPING	473	LF
34-17.4a	8" CURED-IN-PLACE PLASTIC LINER Includes all necessary bypass pumping	64,796	LF
34.-17.4b	10" CURED-IN-PLACE PLASTIC LINER Includes all necessary bypass pumping	2,062	LF
34-17.4c	12" CURED-IN-PLACE PLASTIC LINER	3,105	LF

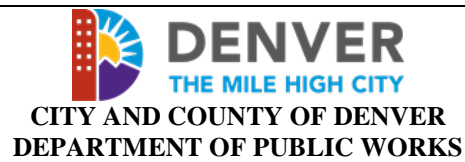

**STATEMENT OF QUANTITIES**

<u>Item No.</u>	<u>Description</u>	<u>Estimated</u>	<u>Quantity</u>
34.-17.4d	15" CURED-IN-PLACE PLASTIC LINER	340	LF
34-17.4e	18" CURED-IN-PLACE PLASTIC LINER	120	LF
34.-17.4f	21" CURED-IN-PLACE PLASTIC LINER	473	LF
34-17.5	GRINDING	3,000	LF
34-17.6a	SANITARY SEWER SERVICE REACTIVATION (CIPP). Estimated tap amount.	3,000	EA
34-17.7	EXTENDED TAP CUTTING	100	EA
41-1	TRAFFIC CONTROL	1	LS
45-1	CIPP LABORATORY TESTING	20	EA
50-1	MOBILIZATION	1	LS
01-55.26.01A	TRAFFIC CONTROL Uniform traffic control – assumed 6 days	\$6,000.00	A/A

25 ITEMS



**CITY AND COUNTY OF DENVER  
DEPARTMENT OF PUBLIC WORKS**

**NOTICE FOR INVITATION FOR BIDS  
FOR CONTRACT NO. 201843656**

**GENERAL SANITARY - CHERRY CREEK IMPROVEMENTS**

**BID SCHEDULE:  
11:00 a.m., Local Time  
August 30, 2018**

Sealed bids will be received in Room 6.G.7, 201 W. Colfax Ave., Denver, CO 80202, beginning at 10:30 a.m., no later than 11:00 a.m., on bid day. All properly delivered bids will then be publicly opened and read aloud.

Bids submitted prior to 10:30 a.m. on the specified bid opening date/time shall be presented at the Office of Contract Administration, Attention: Diane Mora - Public Works Contract Administration, 201 W. Colfax Ave., Department 614, Denver, CO 80202.

Prior to submitting a bid, the bidder shall consult the Contractor's Bulletin Board located at 201 W. Colfax Ave., 2<sup>nd</sup> Floor, Denver, CO 80202 and/or [www.work4denver.com](http://www.work4denver.com).

**GENERAL STATEMENT OF WORK:**

A neighborhood lining program to rehabilitate deteriorated clay sanitary sewer pipes throughout the neighborhood with a pipeliner. This method of rehabilitation requires no excavation which reduces costs and impacts to the community. This project location is in the Cherry Creek East neighborhood.

**ESTIMATED CONSTRUCTION COST:**

The estimated cost of construction for this project is between \$1,939,000.00 and \$2,370,000.00.

**TEXTURA CONSTRUCTION PAYMENT MANAGEMENT:**

Bidders are required, when preparing a bid, to agree that it shall use the Textura® Construction Payment Management System (CPM System) for this Project and recognizes that all fees associated with the CPM System are to be paid by the awarded Contractor for billings for work performed. Use the pricing scale provided in Instructions to Bidders to price the Textura service appropriately. For details on the company and service contact the Textura® Corporation 866-TEXTURA or [www.texturacorp.com](http://www.texturacorp.com).

**DOCUMENTS AND BID INFORMATION AVAILABLE:**

Contract Documents complete with Technical Specifications and, if applicable, construction drawings will be available on the first day of publication at: [www.work4denver.com](http://www.work4denver.com). To download digital Contract Documents at a cost of \$10.00 per download, reference eBid Document Number #5881502 Contact QuestCDN at 952-233-1632 or [info@questcdn.com](mailto:info@questcdn.com) for assistance.

**PRE-BID CONFERENCE:**

A pre-bid conference will be held for this project at 9:00 a.m. local time, on August 13, 2018. This meeting will take place at: the WEBB Building, 201 W Colfax Ave, 4<sup>th</sup> floor conference room 4.I.5., Denver, Colorado 80202.

**DEADLINE TO SUBMIT QUESTIONS:** August 17, 2018 by 2:00 p.m. local time.

**PREQUALIFICATION REQUIREMENTS:**

Each bidder must be prequalified as a 1E(6) - SEWER-REHABILITATION in the \$3,000,000.00 monetary level in accordance with the City's Rules and Regulations Governing Prequalification of Contractors. Each bidder must have submitted a prequalification application a minimum of ten (10) calendar days prior to the bid opening date. Applications must be submitted to the Department of Public Works, Prequalification Section, 201 W. Colfax Ave., Department 614, Denver, CO 80202. To view the Rules and Regulations and to obtain a prequalification application, please visit our website at [www.denvergov.org/prequalification](http://www.denvergov.org/prequalification) or call 720-865-2539 for prequalification information ONLY.

**MINORITY AND WOMAN BUSINESS ENTERPRISE PARTICIPATION:**

Construction, reconstruction and remodeling contracts made and entered into by the City and County of Denver are subject to Article III, Divisions 1 and 3 of Chapter 28 of the Denver Revised Municipal Code, (Sections 28-31 to 28-36 and 28-52 to 28-90 D.R.M.C) and all Minority and Woman Business Enterprise and Equal Employment Opportunity Rules and Regulations adopted by the Director of the Division of Small Business Opportunity.

Article III, Division 3 of Chapter 28 of the D.R.M.C. directs the Director of the Division of Small Business Opportunity to establish a project goal for expenditures on construction, reconstruction, and remodeling work contracted by the City and County of Denver. The specific goal for this project is:

**8% Minority and Woman Business Enterprise (M/WBE) Participation**

Project goals must be met with certified participants as set forth in Section 28-60, D.R.M.C. or through the demonstration of a sufficient good faith effort under Section 28-62 D.R.M.C. For compliance with good faith requirements under Section 28-62(b), **the M/WBE percentage solicitation level required for this project is 100%.**

The Director of the Division of Small Business Opportunity urges all participants in City construction, reconstruction and remodeling projects to assist in achieving these goals.

**MISCELLANEOUS:**

Contracts for construction, reconstruction, and remodeling are subject to the City prevailing wage rate requirements established pursuant to Section 20-76, D.R.M.C.

As its best interest may appear, the City and County of Denver reserves the right to reject any or all bids and to waive informalities in bids.

A modified version of this Notice of Invitation for Bids and the project's Statement of Quantities is available on the City and County of Denver's website at: [www.work4denver.com](http://www.work4denver.com).

Publication Dates: August 1, 2, 3, 2018

Published In: The Daily Journal

**CITY AND COUNTY OF DENVER**  
**DEPARTMENT OF PUBLIC WORKS**

**INSTRUCTIONS TO BIDDERS**

**IB-1 INSTRUCTION TO BIDDERS**

These Instructions to Bidders are a part of the Contract Documents and are intended to serve as a guide to bidders. They are general in nature and may be amended or supplemented as needed to support any one specific invitation to bid. Each bidder shall prepare its bid in strict compliance with all requirements of the Contract Documents and by careful application of these instructions.

**IB-2 BIDDING**

The copy of the Contract Documents contains the Bid Form and Submittal Package for this Project, which must be used to submit a bid hereunder. The bidder must fully complete, execute and submit this Bid Form and Submittal Package, along with any other specified components of the Contract Documents, as its bid for the referenced Project.

A bidder is not required to submit as part of its bid the entire set of Contract Documents distributed by the City pursuant to the Notice of Invitation for Bids, if the bidder executes and submits the Bidder Acknowledgment Form included with the Bid Form and Submittal Package as part of its bid. However, each bidder, by submitting its bid, shall be conclusively presumed to have received and reviewed all of the information contained in the Contract Documents as this term is further defined herein.

Each bid must be enclosed in a sealed envelope, must be addressed to the Manager and must show on the face of the envelope the full name of the bidder, the City Project number, and descriptive title of the Project for which the bid is made.

The advertisement for Notice of Invitation for Bids will identify where and when the bid must be delivered.

**IB-3 CONTRACT DOCUMENTS AS PUBLISHED BY CITY**

Each bidder shall be responsible for, and shall be deemed to have received, all the information contained in the Contract Documents as distributed by the City pursuant to the Notice of Invitation for Bids, including addenda, whether or not such bidder has reviewed all or part of the Contract Documents in either its hard copy form or in any other format. If organizations or companies other than the City or its design professional distribute the City's Contract Documents for review by prospective bidders, whether in hard copy or via electronic or other media, neither the City nor its design professional shall be responsible for the content, completeness or accuracy of any information distributed or transmitted by any such organization or company.

**IB-4 COMPLETING AND SIGNING THE BID FORMS**

The bidder must complete the Bid Form by legibly writing or printing in ink, in words and figures as required, all the bidder's prices offered for the Work to be performed. All blank spaces, which require a response of the bidder, must be properly completed in full. If in the process of evaluating a bid, words and figures, as written on the Bid Form by the bidder, do not agree, the written words will govern.

For Bid Forms requiring unit price bids, the bidder shall write in the Bid Form spaces provided a unit price for each item for which a quantity is given and shall also write the product of each unit price and the quantity specified in the "Amount" or "Total" space provided.

Each bidder must sign the Bid Form and give the bidder's current business address. If an individual, the signature must be of the individual offering the bid; if a partnership, the signature must be that of a general partner; and if a corporation, both the president and the secretary must sign and the seal of the corporation must be affixed. Signatures of other persons may be acceptable if the bid contains sufficient evidence, satisfactory to the City in its sole discretion, to indicate that the other persons are authorized to bind the bidder.

**IB-5 UNACCEPTABLE BIDS**

The City will not accept bids from Bidders not prequalified with the Department of Public Works (if prequalification is required for this project), in arrears to the City upon debt or contract, or which are defaulters (as surety or otherwise) upon any obligation to the City.

**IB-6 INFORMAL AND UNBALANCED BIDS**

Any alteration, interlineations, erasure, omission, deletion or addition by the bidder to the Bid Form and Submittal Package or other parts of the Contract Documents submitted with the Bid Form and Submittal Package, as originally issued to the bidder, shall render the accompanying bid informal and may constitute cause for rejection.

Any unauthorized addition, conditional or alternate bids, failure to provide a unit price, lump sum amount or authorized alternate item specified or other irregularities of any kind which tend to render the bid incomplete, indefinite or ambiguous shall render the bid informal and may constitute cause for rejection.

Bids that are unbalanced so that each item does not reasonably carry its own proportion of cost or that contain inadequate or unreasonable prices for any item may be rejected. Bids, which have not acknowledged all addenda to the Contract Documents issued for this bid, may also be rejected.

The right is reserved by the City to reject any or all bids and to waive any informalities where it is deemed by the City to be in the best interests of the City to do so.

**IB-7 ONLY ONE BID ACCEPTED**

The City will accept only one bid for the same work from any one bidder. This includes bids that may be submitted under different names by one business enterprise.

**IB-8 BID GUARANTEE**

As a guarantee of good faith on the part of the bidder, each bid must be accompanied by a bid guarantee, consisting of either a certified or cashier's check made payable without condition to the order of the City and County of Denver or a bid bond written by an approved corporate surety in favor of the City and County of Denver. If the bid of a bidder is acceptable and the bidder is notified by the Manager that it is considered to be the Apparent Low Bidder and said bidder fails to execute a contract in the form prescribed or to furnish a performance and payment bond with a legally responsible and approved surety or to furnish the required evidence of insurance or satisfy all conditions precedent to contract execution within five (5) days after such notice is made by the City, said bid guarantee shall be forfeited to the City as liquidated damages and not as a penalty.

The bid guarantee shall be in the amount of five percent (5%) of the total bid unless otherwise specified in the Notice of Invitation for Bids and on the form appearing in the Contract Documents in the Bid Form and Submittal Package. Failure to submit a properly executed bid guarantee, on the form provided herein may, in the City's sole discretion, constitute cause for rejection.

Following award and execution of the Contract by the Apparent Low Bidder, or earlier in the sole discretion of the City, bid guarantees of all but the Apparent Low Bidder will be returned. When the Apparent Low Bidder executes the Contract and delivers to the City satisfactory performance and payment bonds, required insurance documentation, and has satisfied all conditions precedent to contract execution by the City, and after approval, if any, by the Council of the City of the proposed Contract with the Apparent Low Bidder, the bid guarantee of the Apparent Low Bidder shall be returned. Such return shall be made within one hundred twenty (120) days from date bids are opened unless otherwise specified in the Special Contract Conditions.

**IB-9 SITE INSPECTION AND INVESTIGATIONS**

Prior to submitting a bid, the bidder is invited to inspect the work site and its surroundings. Although the bidder is not required to make such an inspection before bidding, for purposes of the Contract it shall be conclusively presumed that by failing to make such an inspection, the bidder has waived the right to later claim additional compensation or time extensions for conditions which would have been evident had the site been inspected.

Drawings and Technical Specifications, defining the Work to be done, were prepared on the basis of interpretation by the design professionals of information derived from investigations of the work site. Such information and data are subject to sampling errors, and the interpretation of the information and data depends to a degree on the judgment of the design professional. In view of this, the bidder is invited to make such additional investigations as the bidder's judgment dictates the need for such investigations. Information about the degree of difficulty of the Work to be done cannot totally be derived from either the Drawings or Technical Specifications or from the Manager or his representatives.

Since the bid information cannot be guaranteed, the Contractor shall have assumed the risks attendant to successful performance of the Work and shall never make claim for additional compensation or time extensions on the grounds that the nature or amount of work to be done was not understood by the bidder at the time of the bidding.

**IB-10 INCONSISTENCIES**

Any seeming inconsistencies or ambiguities between different provisions of the Contract Documents or any point which the bidder believes requires a decision or interpretation by the City must be inquired into by the bidder by addressing a formal written communication to the Manager of Public Works and sending or delivering it to the offices of the Division of Public Works advertising this Project for bid at least forty-eight (48) hours, excluding Saturdays, Sundays, and holidays, before the time set for the opening of bids

Information about the decision or interpretation made in response to any inquiry will be posted on the Contractor's Bulletin Board (refer to IB-12 CONTRACTOR'S BULLETIN BOARD, for the location of the Contractor's Bulletin Board). If the matter raised requires, in the sole discretion of the Manager, that an addendum to the bid documents be issued, such addendum will be published and each bidder shall be required to acknowledge the addendum by signing and identifying it in the Bid Form when submitting the bid.

After bids are opened, all bidders must abide by the formal response of the Manager, as to any interpretation. The City shall not be bound and the bidder shall not rely on any oral communication, interpretation clarification or determination of the Contract Documents prior to bid opening.

**IB-11 WITHDRAWAL OF BID**

A bidder may withdraw its bid at any time prior to the time for receipt of bids set forth in the Notice of Invitation for Bids by making written request upon the Manager of Public Works. After such time, no bid may be withdrawn or modified.

Such request must be signed by the persons authorized to bind the bidder as defined in IB-3, COMPLETING AND SIGNING BID FORMS.

**IB-12 CONTRACTOR'S BULLETIN BOARD**

It shall be conclusively presumed that the bidder has, before submitting any bid, read and shall take full responsibility for all addenda, posted decisions, and other information relevant to the bid posted by the City on the Contractor's Bulletin Board. The Contractor's Bulletin Board is located at 201 W. Colfax, 2<sup>nd</sup> Floor, Denver, CO 80202, in the Wellington E. Webb Municipal Office Building.

**IB-13 PRE-BID MEETING**

Bidders are urged to attend the pre-bid meeting(s) scheduled for this Project. Attendance is not mandatory; however, bidders will be held responsible for all information presented at such meeting(s).

**IB-14 ADDENDA**

As its best interests may require, the City may issue addenda to the Contract Documents. Such addenda shall be posted on the Contractor's Bulletin Board and made available to all persons having purchased a set of Contract Documents as set forth in the Notice of Invitation for Bids contained herein. All bidders must acknowledge receipt of all addenda on the Bid Form at the time of submission of the bid.

**IB-15 BID OPENING**

Bidders are invited to be present at the bid opening. Unless otherwise suspended, delayed or canceled by posted notice from the Manager, bid opening will occur at the time and place designated in the Notice of Invitation for Bid.

**IB-16 EVALUATION OF BIDS AND BASIS OF BID SELECTION**

Bids will be evaluated after being read in open meeting at the place designated for such bid opening. All low bidders' bids will be reviewed for responsiveness to the requirements of the Contract Documents and whether or not the bids contain irregularities which could give any bidder an unfair advantage.

Selection will be made on the basis of the lowest, total, responsive, qualified bid, which bid shall include the total base bid set forth on the Bid Form, plus the total of any alternates set forth on the Bid Form and selected by the City during evaluation. Alternates, if any are included in the bid, will be selected in the priority shown on the Bid Form, subject to the limits of available funds. Bid selection will be subject to all requirements and special bidder qualifications contained herein and subject to approval of such resulting Contract in accordance with the Charter and Revised Municipal Code of the City and County of Denver. In addition to all other specified requirements, the City will correct arithmetical errors in all bids and corrected totals only will be considered as the basis of selection.

Upon concluding that the bid is, in fact, the lowest, total, responsive bid to the bidding conditions and that of a responsible, qualified bidder, the City will notify the Apparent Low Bidder.

As its best interests may appear, the City and County of Denver reserves the right to waive informalities in bids, to reject any and all bids and to rebid the Project.

**IB-17 NOTICE TO APPARENT LOW BIDDER**

The Notice to Apparent Low Bidder, a form of which is included in the Contract Special Conditions Section of the Contract Documents, is issued by the City directly to the selected bidder and informs the bidder that the Manager intends to seek approval of the execution of the Contract by the City in accordance with the Charter and Revised Municipal Code of the City and County of Denver. Specifically, it informs the bidder of its obligations with respect to execution of the Contract and instructs the bidder on how to proceed toward execution of the Contract. The City reserves the right to notify the Apparent Low Bidder, at any time within one hundred twenty (120) days from the date of the opening of the bids, that approval to contract with the Apparent Low Bidder shall be sought in accordance with the Charter and Revised Municipal Code of the City and County of Denver.

In accordance with the terms and conditions contained in the Bid Form and Submittal Package and any additional requirements set forth in the Notice to Apparent Low Bidder or elsewhere in the Contract Documents, the Apparent Low Bidder shall execute the Contract Form contained in the Contract Documents made available by the City for execution in the appropriate number of counterparts. The Apparent Low Bidder shall return the fully executed Contract Document sets, along with any supplemental documents required herein, to the City and shall comply with all other conditions precedent to Contract execution within five (5) days of the date of issuance of the Notice to Apparent Low Bidder by the City. Failure to comply with each of these requirements within five (5) days of the date of issuance of the Notice to Apparent Low Bidder by the City shall render the bid nonresponsive and may constitute cause for rejection.

Issuance of such Notice shall not, however, constitute a commitment on the part of the City or create any rights in the Apparent Low Bidder to any contract with the City.

**IB-18 EXECUTION OF CONTRACT**

The process of executing a contract requires action by both the apparent low bidder and the City. After it notifies the Apparent Low Bidder, the City will prepare the Contract Documents by incorporating all of the documents submitted by the Apparent Low Bidder into one or more executable copies. Upon notification that contracts documents are ready for execution the Apparent Low Bidder shall execute the contract documents. At this time, the successful bidder shall also provide certain supplemental documents for incorporation into the Contract Documents. These supplemental documents shall include: the properly executed Certificate of Insurance Forms evidencing the apparent low bidder's satisfactory compliance with

the insurance requirements set forth in the Contract Documents; a properly executed Payment and Performance Bond Form and appropriate Power of Attorney evidencing the Apparent Low Bidder's satisfactory compliance with the bonding requirements set forth in the Contract Documents; and documentation of compliance with any other conditions precedent to execution of the Contract by the City set forth in the Contract Documents. The insurance and bond forms contained in the Contract Special Conditions Section of the Contract Documents must be used in satisfying these supplemental document requirements.

These documents are then delivered to the City within the prescribed time period for examination of the documents to determine whether or not the Contractor has correctly executed the Contract and has correctly provided the required supplemental documents and that these documents are satisfactorily and properly completed. From here, all of the documents are forwarded to the City Attorney who will, if the insurance and bonding offered is acceptable and if all other elements of the Contract Documents are in order, recommend that the Manager and the Mayor approve the documents and, when required by the City Charter, prepare an ordinance for submittal to City Council authorizing the execution of the Contract. The City Attorney shall in all applicable instances submit the proposed contract and ordinance to City Council. After City Council approval, the Contract shall be reviewed by the City Attorney and routed for execution by the Mayor, the Clerk for attestation and the Auditor for countersignature and registration. When the total process of contract execution is complete, a Notice to Proceed will be issued and a single executed copy of the Contract will be delivered to the Contractor. Any work performed or a material purchased prior to the issuance of Notice to Proceed is at the Contractor's risk.

**IB-19 BONDING REQUIREMENTS**

In accordance with the provisions of General Contract Conditions, Title 15, PERFORMANCE AND PAYMENT BONDS, the minimum bonding requirements for this Contract are set forth in the form **CITY AND COUNTY OF DENVER PERFORMANCE AND PAYMENT BOND** contained in the Special Conditions Section of the Contract Documents. Upon receipt of Notice to Apparent Low Bidder, the apparent low bidder must cause this form bond to be purchased, executed and furnished, along with appropriate Powers of Attorney and a surety authorization letter (in form similar to the one attached), to the City in accordance with the instructions contained herein.

**IB-20 INSURANCE REQUIREMENTS**

The minimum insurance requirements for this Contract are set forth in the Special Conditions Section of the Contract Documents. Bidders are urged to consider, in preparing a bid hereunder, that each condition, requirement or specification set forth in the form certificate must be complied with by the Contractor and all subcontractors performing Work on the Project, unless such requirements are specifically accepted in writing by the City's Risk Management Office. The Contractor must either include all subcontractors performing work hereunder as insureds under each required policy or furnish a separate certificate for each subcontractor. In either case, the Contractor shall insure that each subcontractor complies with all of the coverage requirements.

**IB-21 PERMITS AND LICENSES**

All permits, licenses and approvals required in the prosecution of the work shall be obtained and paid for by the Contractor.

**IB-22 PREVAILING WAGE REQUIREMENTS**

Contractor shall comply with, and agrees to be bound by, all requirements, conditions and City determinations regarding the Payment of Prevailing Wages Ordinance, Sections 20-76 through 20-79, D.R.M.C. including, but not limited to, the requirement that every covered worker working on a City owned or leased building or on City-owned land shall be paid no less than the prevailing wages and fringe benefits in effect on the date the bid or request for proposal was advertised. In the event a request for bids, or a request for proposal, was not advertised, Contractor shall pay every covered worker no less than the prevailing wages and fringe benefits in effect on the date funds for the contract were encumbered.

Date bid or request for qualifications/proposals was advertised: August 1, 2018.

Prevailing wage and fringe rates will adjust on, and only on, the anniversary of the date the Contract was fully executed. Unless expressly provided for in this Agreement, Contractor will receive no additional compensation for increases in prevailing wages or fringe benefits.

Contractor shall provide the Auditor with a list of all subcontractors providing any services under the contract.

Contractor shall provide the Auditor with electronically-certified payroll records for all covered workers employed under the contract.

Contractor shall prominently post at the work site the current prevailing wage and fringe benefit rates. The posting must inform workers that any complaints regarding the payment of prevailing wages or fringe benefits may be submitted to the Denver Auditor by calling 720-913-5000 or emailing [auditor@denvergov.org](mailto:auditor@denvergov.org).

If Contractor fails to pay workers as required by the Prevailing Wage Ordinance, Contractor will not be paid until documentation of payment satisfactory to the Auditor has been provided. The City may, by written notice, suspend or terminate work if Contractor fails to pay required wages and fringe benefits.

### **IB-23 TAX REQUIREMENTS**

General. Bidders are referred to the General Contract Condition 323, TAXES, as to taxes to which they may be subject in performing the Work under this Contract, including but not limited to sales and use taxes and the Denver Occupational Privilege Tax. The following instructions are to be considered along with the General Contract Conditions and not in lieu of them.

Sales and Use Tax. Construction and building materials sold to contractors and subcontractors for use on structures, roads, streets, highways, and other public works owned by the City and County of Denver are exempt from state, RTD, and Cultural Facilities District sales and use taxes. However, such materials will be subject to sales and use taxes imposed by the City and County of Denver.

It is the responsibility of the Contractor and its subcontractors to apply to the Colorado Department of Revenue (“CDOR”) for a certificate, or certificates, of exemption indicating that their purchase of construction or building materials is for a public project, and to deliver to the City copies of such applications as soon as possible after approval by the CDOR. Bidders shall not include in their bid amounts the exempt state, RTD, and Cultural Facilities District Sales and Use Taxes.

Denver Occupational Privilege Tax. Any employee working for a contractor, or a subcontractor, who earns over \$500 working in Denver during a calendar month, is subject to the payment of the Employee Occupational Privilege Tax. The Contractor and any subcontractor must pay the Business Occupational Privilege Tax for each of its employees who are subject to such tax.

### **IB-24 DIVERSITY AND INCLUSIVENESS IN CITY SOLICITATIONS**

Each bidder shall, as a condition of responsiveness to this solicitation, complete and return the “Diversity and Inclusiveness in City Solicitations Information Request Form” with their Bid.

Using the “Diversity and Inclusiveness in City Solicitations Information Request Form” provided, please state whether you have a diversity and inclusiveness program for employment and retention, procurement and supply chain activities, or customer service and provide the additional information requested on the form. The information provided on the “Diversity and Inclusiveness in City Solicitations Information Request Form” will provide an opportunity for City contractors to describe their own diversity and inclusiveness practices. Contractors are not expected to conduct intrusive examinations of its employees, managers, or business partners in order to describe diversity and inclusiveness measures. Rather, the City simply seeks a description of the contractor’s current practices, if any.

Diversity and Inclusiveness information provided by City contractors in response to City solicitations for services or goods will be collated, analyzed, and made available in reports consistent with City Executive Order No. 101. However, no personally identifiable provided by or obtained from contractor’s will be in such reports.



## **IB-25 MINORITY AND WOMAN BUSINESS ENTERPRISE (M/WBE) REQUIREMENTS**

Article III, Divisions 1 and 3 of Chapter 28, Denver Revised Municipal Code (D.R.M.C.), designated as Sections 28-31 – 28-36 and 28-52 – 28-90 D.R.M.C. and referred to in these Bid Documents as the “M/WBE Ordinance” and any Rules or Regulations promulgated pursuant thereto apply to this Project and are incorporated into these Bid Documents by reference. Generally, the M/WBE Ordinance provides for the adoption of a good faith goals program, to be administered by the Division of Small Business Opportunity (DSBO), devised to provide increased bidding opportunities for Minority and Woman Business Enterprises (M/WBEs). As such, each bidder must comply with the terms and conditions of the M/WBE Ordinance in making its bid and, if awarded the Contract, in performing all Work thereunder. A bidder’s failure to comply with the M/WBE Ordinance, any Rules or Regulations promulgated pursuant thereto, or any additional requirement contained herein shall render the bid non-responsive and shall constitute cause for rejection. Failure by the contractor awarded the contract to comply with M/WBE Ordinance requirements during the performance of the contract is a material breach of the contract, which may result in the imposition of sanctions on the Contractor, as deemed appropriate by DSBO. Copies of the M/WBE Ordinance and its accompanying Rules and Regulations are available for the use and review of bidders from DSBO. In order to comply with the bid requirements of the M/WBE Ordinance, a bidder shall either meet the established project goal or, in the alternative, demonstrate that the bidder has made sufficient good faith efforts to meet the goal in accordance with the M/WBE Ordinance.

### **Meeting Established Goal**

In preparing a bid to meet the established Project goal, bidders should consider the following instructions relating to compliance with the M/WBE Ordinance:

1. Under the M/WBE Ordinance, the Director of DSBO (“Director”) is directed to establish project goals for expenditures on construction, reconstruction, and remodeling work performed for the City and County of Denver. The specific goal for this project is stated in the Notice of Invitation for Bids bound herein.
2. In preparing its bid, each bidder shall list on the Bid Form pages entitled "List of Proposed MWBE Bidders, Subcontractors, Suppliers, Manufacturers, Manufacturers' Representatives or Brokers" the name, address, work description/supply, committed level of participation and other required information for each M/WBE of any tier which the bidder intends to use in performing the work on this Project. **Only the M/WBEs identified and the precise levels of participation listed for each on the Bid Form page, at the time of bid opening, will be considered in determining whether the bidder has met the designated participation goal. Additional, revised or corrected participation submitted after bid opening will not be considered.** M/WBE bidders may count self-performance or joint venture activity in meeting the M/WBE project goal, but only for the scope of work performed as a commercially useful function and at a percentage level the M/WBE will be performing itself.
3. Any agreement between a bidder or proposer and an MBE or WBE in which the bidder or proposer requires that the MBE or WBE not provide subcontracting quotations to other bidders or proposers is prohibited and shall render a bidder's bid or proposer's proposal nonresponsive. D.R.M.C. 28-63(f)
4. If a bidder/proposer is participating in a joint venture with a certified M/WBE firm, complete the Joint Venture Eligibility Form and Joint Venture Affidavit contained in this bid document/RFP. Submit the aforementioned forms with the firm’s Joint Venture Agreement, to the DSBO Director, **at least 10 working days prior to the proposal submittal.** The Joint Venture must be approved prior to the bid opening or proposal submittal by the DSBO Director. Approval by the DSBO Director includes determining the amount the Joint Venture will count towards meeting the project goal.
5. All M/WBEs listed on the Bid Form must be properly certified by the City on or before the date bids are opened in order to count towards meeting the designated goal. DSBO maintains an M/WBE Directory (“Directory”), which is a current listing of M/WBEs that have been certified by the City. A copy of the DSBO Directory is located at DSBO web site at <https://www.denvergov.org/dsbo>.

Bidders are encouraged to use the Directory to assist in locating M/WBEs for the work and supplies required on the Project. Bidders are reminded that changes may be made to the Directory at anytime in accordance with the City's M/WBE Ordinance and procedures established to administer this program and a current copy of the Directory must always be used in preparing a bid. M/WBE certification or listing in the Directory is not a representation or warranty by the City as to the qualifications of any listed M/WBE.

6. In accordance with the provisions of the M/WBE Ordinance, DSBO will evaluate each bid to determine the responsiveness of the bid to the requirements of the M/WBE Ordinance. In determining whether a bidder's committed level of participation meets or exceeds the stated M/WBE goal, DSBO shall base its calculation of applicable amounts and percentages on the total base bid amount, not including any listed alternates, of each bid as follows:
  - a. The bid information provided by the agency will be used to determine the total base bid amount of each bid. Each bidder's total base bid amount will be multiplied by the M/WBE percentage established for the project to determine the exact dollar amount of required M/WBE participation for the Project. This amount will then be compared against the exact dollar amounts for the M/WBE committed for participation by the bidder. If the total dollar amount of participation listed meets or exceeds the established M/WBE dollar amount goal listed, then DSBO will determine that the goal has been met.
  - b. In addition, DSBO will determine the exact commitment percentage for each listed M/WBE by dividing the dollar amount listed for each M/WBE by the total base bid dollar amount submitted by the bidder. These individual percentages, when totaled for all listed M/WBE, will establish the total committed percentage level of M/WBE participation that the bidder must comply with during the life of the contract. In all cases, the committed percentage level of M/WBE participation must equal or exceed the assigned M/WBE goal for the Project.
  - c. In providing the exact dollar amount of participation for each listed M/WBE, a bidder should take care never to round up in determining whether or not the total of these amounts meets or exceeds the established percentage goal. The goal must be met or exceeded by dollar amounts and percentages in order for DSBO to determine that the bidder has met or exceeded the applicable M/WBE goal.
  - d. As previously mentioned, compliance with the M/WBE goal will be determined on the base bid alone. If a bid contains alternates, participation contained in any alternate will not count towards satisfaction of the Project goal. However, should any designated alternate be selected by the City for inclusion in the contract ultimately awarded, the M/WBE goal percentage level submitted at bid time, on the base bid, will also apply to the selected alternates and must be maintained for the life of the contract on the total contract amount, including any alternate work. Thus, even though such participation will not be considered in evaluating bids, bidders are urged to consider participation in preparing bids for designated alternates.
  - e. On projects where force account or allowance bid items have been included, bidders must meet the M/WBE goal percentage based upon the total base bid, including all such items that are submitted to the City. However, when a force account or allowance is designated by the City to be either performed or purchased from a specific company, the bidder may back out the dollar amount of the force account or allowance from the total base bid and meet the M/WBE goal on the remaining reduced amount.
  - f. On bids which, at the time of bid opening, are equal to or exceed Five Million Dollars (\$5,000,000.00), including any alternates which may be selected, only sixty percent (60%) of the value of the commercially useful function performed by M/WBE suppliers shall count toward satisfaction of the Project goal. On Projects under Five Million (\$5,000,000.00) the value of the commercially useful function of M/WBE supplier(s) will

count at a one hundred percent (100%) level. Manufacturer's representatives and packagers shall be counted in the same manner as brokers.

- g. In utilizing the M/WBE participation of a Broker only the bona fide commissions earned by such Broker for its performance of a commercially useful function will count toward meeting the Project goals. The bidder must separate the bona fide brokerage commissions from the actual cost of the supplies or materials provided to determine the actual dollar amount of participation that can be counted towards meeting the goal.
7. On or before the third (3<sup>rd</sup>) working day after bid opening, all of the Bidders are required to submit an executed "Letter of Intent" for each M/WBE listed on the Bid Form as a joint venture member, subcontractor, supplier, manufacturer, manufacturers' representative or broker of any tier. **An MBE or WBE Prime Bidder needs to submit a Letter of Intent for itself for self performed work**, and must identify their level of participation on the designated M/WBE participation page bound herein. A Letter of Intent shall be submitted only for the M/WBEs listed at the time of bid opening, since this is the only participation that will be counted toward satisfaction of the project goal. A form for the M/WBE Letter of Intent is included with the Bid Form. The M/WBE Letter of Intent is a written communication from the Bidder to the City evidencing an understanding that the Bidder has or will enter into a contractual relationship with the M/WBE or that its subcontractor(s) and supplier(s), manufacturer(s), manufacturers' representative(s) and broker(s) will do so. Each M/WBE Letter of Intent shall be accompanied by a copy of the City and County of Denver's M/WBE certification letter for each proposed M/WBE identified at bid time. Bidders are urged to carefully review these Letters before submission to the City to ensure that they are properly completed and executed by the appropriate parties.

#### **Good Faith Effort.**

In preparing a bid to demonstrate a good faith effort, bidders should consider the following instructions relating to compliance with the M/WBE Ordinance:

1. If the bidder or proposer has not fully met the project goal as provided in section 28-60, then it shall demonstrate that it has made good faith efforts to meet such goal. The bidder or proposer shall furnish to the director, within three (3) working days after bid opening by the City or on or before the time of the final project-specific proposal submitted to and authorized by the City pursuant to a competitive selection process, or bid selection by a private owner, a detailed statement of its good faith efforts to meet the project goal set by the director. This statement shall address each of the items in subsection (b) and any additional criteria that the director may establish by rule or regulation consistent with the purposes of this division 3. Good faith efforts must be demonstrated to be meaningful and not merely for formalistic compliance with this Division 3. The scope and intensity of the efforts will be considered in determining whether the bidder or proposer has achieved a good faith effort.
2. The statement of good faith efforts shall include a specific response and verification with respect to each of the following good faith effort categories, which may be further defined by rule or regulation. A bidder or proposer may include any additional information it believes may be relevant. Failure of a bidder or proposer to show good faith efforts as to any one (1) of the following categories shall render its overall good faith effort showing insufficient and its bid or proposal non-responsive:
  - a. If prebid or preselection meetings are scheduled by the City at which MBEs and WBEs may be informed of subcontracting or joint venture opportunities under a proposed contract to be bid, or procured pursuant to the competitive selection process, attendance at such prebid or preselection meetings is not mandatory; however, bidders and proposers are responsible for the information provided at these meetings.
  - b. The bidder or proposer must solicit through all reasonable and available means, the interest of all MBEs and WBEs certified in the scopes of work of the contract. The bidder or proposer must solicit the interest of such MBEs and WBEs within sufficient time, prior to the bid opening or date of final project-specific proposal in the case of a competitive selection process, to allow such MBEs and WBEs to respond to the solicitation. The bidder or proposer must determine with certainty

- if the MBEs and WBEs are interested by demonstrating appropriate steps to follow up initial solicitations.
- c. The bidder or proposer must select portions of the work of the contract to be performed by MBEs and WBEs in order to increase the likelihood that the project goal will be achieved. This includes, where appropriate, breaking out contract work items into economically feasible units to facilitate MBE and WBE participation as subcontractors or joint venturers, and for bidder or proposer self-performed work, as suppliers, manufacturers, manufacturer's representatives and brokers, all reasonably consistent with industry practice, even when the bidder or proposer would otherwise prefer to perform these work items with its own forces. The bidder or proposer must identify what portions of the contract will be self-performed and what portions of the contract will be opened to solicitation of bids, proposals and quotes from MBE and WBEs. All portions of the contract not self-performed must be solicited for MBE and WBE participation. The ability or desire of a bidder or proposer to perform the work of a contract with its own forces does not relieve the bidder or proposer of the responsibility to meet the project goal or demonstrate good faith efforts to do so.
  - d. The bidder or proposer, consistent with industry practice, must provide MBEs and WBEs at a clearly stated location with timely, adequate access to and information about the plans, specifications, and requirements of the contract, including bonding and insurance requirements, if any, to assist them in responding to a solicitation.
  - e. The bidder or proposer must negotiate in good faith with interested MBEs and WBEs and provide written documentation of such negotiation with each such MBE or WBE.
  - f. For each MBE or WBE which contacted the bidder or proposer or which the bidder or proposer contacted or attempted to subcontract or joint venture with, consistent with industry practice, the bidder or proposer must supply a statement giving the reasons why the bidder or proposer and the MBE or WBE did not succeed in negotiating a subcontracting, supplier, manufacturer, manufacturer's representative, broker or joint venture agreement, as applicable.
3. The bidder or proposer must provide verification that it rejected each non-utilized MBE and WBE because the MBE or WBE did not submit the lowest bid or it was not qualified. Such verification shall include a verified statement of the amounts of all bids received from potential or utilized subcontractors, suppliers, manufacturers, manufacturer's representatives, brokers or joint venturers on the contract, whether or not they are MBEs or WBEs. In making such a determination of not being qualified, the bidder or proposer shall be guided by the definition of qualified in section 28-54(42), but evidence of lack of qualification must be based on factors other than solely the amount of the MBE's or WBE's bid. For each MBE or WBE found not to be qualified by the bidder or proposer, the verification shall include a statement giving the bidder's or proposer's reasons for its conclusion. A bidder's or proposer's industry standing or group memberships may not be the cause of rejection of an MBE or WBE. A bidder or proposer may not reject an MBE or WBE as being unqualified without sound reasons based on a reasonably thorough investigation and assessment of the MBE's or WBE's capabilities and expertise.
  4. If requested by a solicited MBE or WBE, the bidder or proposer must make reasonable efforts to assist interested MBEs and WBEs in obtaining bonding, lines of credit, or insurance as required by the City or by the bidder or proposer, provided that the bidder or proposer need not provide financial assistance toward this effort.
  5. If requested by a solicited MBE or WBE, the bidder or proposer must make reasonable efforts to assist interested MBEs and WBEs in obtaining necessary and competitively priced equipment, supplies, materials, or related assistance or services for performance under the contract, provided that the bidder or proposer need not provide financial assistance toward this effort.

6. The bidder or proposer must use the DSBO MBE/WBE directories to identify, recruit, and place MBEs and WBEs.
7. In determining whether a bidder or proposer has satisfied good faith efforts as to a project goal, the success or failure of other bidders or proposers on the contract in meeting such project goal may be considered.

### **Continuing Commitments.**

In accordance with the provisions of the M/WBE Ordinance, the bidder agrees that it is committed to meeting either the M/WBE participation goal or the M/WBE participation set forth in its statement of good faith. This commitment must be expressly indicated on the "Commitment to MWBE SBE Participation" form included with the Bid Form. This commitment includes the following understandings:

1. The bidder understands it must maintain M/WBE goals throughout the performance of the Contract pursuant to the requirements set out in D.R.M.C. 28-72.
2. The bidder understands that it must establish and maintain records and submit regular reports, as required, which will allow the City to assess progress in achieving the M/WBE participation goal.
3. The bidder understands that if change orders or any other contract modifications are issued under the contract, the bidder shall have a continuing obligation to immediately inform DSBO in writing of any agreed upon increase or decrease in the scope of work of such contract, upon any of the bases discussed in Section 28-73 of the M/WBE Ordinance, regardless of whether such increase or decrease in scope of work has been reduced to writing at the time of notification.
4. The bidder understands that if change orders or other contract modifications are issued under the contract, that include an increase in scope of work of a contract for construction, reconstruction, or remodeling, whether by amendment, change order, force account or otherwise which increases the dollar value of the contract, whether or not such change is within the scope of work designated for performance by an M/WBE at the time of contract award, such change orders or contract modification shall be immediately submitted to DSBO for notification purposes. Those amendments, change orders, force accounts or other contract modifications that involve a changed scope of work that cannot be performed by existing project subcontractors or by the contractor shall be subject to a goal for M/WBEs equal to the original goal on the contract which was included in the bid. The contractor shall satisfy such goal with respect to such changed scope of work by soliciting new M/WBEs in accordance with Section 28-73 of the M/WBE Ordinance as applicable, or the contractor must show each element of modified good faith set out in Section 28-75(c) of the M/WBE Ordinance. The contractor shall supply to the director the documentation described in Section 28-75(c) of the M/WBE Ordinance with respect to the increased dollar value of the contract.

All bidders are charged with knowledge of and are solely responsible for complying with each and every provision of the M/WBE Ordinance in making a bid and, if awarded, in performing the work described in the Contract Documents. Failure to comply with these provisions could constitute cause for rejection of a bid or subject the selected contractor to sanctions set forth in the M/WBE Ordinance. These instructions are intended only to generally assist the bidder in preparing and submitting a compliant bid. Should any questions arise regarding specific circumstances, bidders must consult the M/WBE Ordinance or contact the Project's designated DSBO representative at (720) 913-1999.

### **IB- 26 DISCLOSURE OF INFORMATION**

All submissions and other materials provided or produced pursuant to this Invitation for Bids may be subject to the Colorado Open Records Law, C.R.S. 24-72-201, et seq. As such, bidders are urged to review these disclosure requirements and any exceptions to disclosure of information furnished by another party and, prior to submission of a bid to the City, appropriately identify materials that are not subject to disclosure. In the event of a request to the City for disclosure of such information, the City shall advise the bidder of such request to give the bidder an opportunity to object to the disclosure of designated confidential materials furnished to the City. In the event of the filing of a lawsuit to compel such disclosure, the City will tender all such material to the court for judicial determination of the issue of disclosure and each bidder agrees to intervene in such lawsuit to protect and assert its claims of privilege against disclosure of such material. Each

bidder further agrees to defend, indemnify and save and hold harmless the City, its officers, agents and employees, from any claim, damages, expense, loss or costs arising out of the bidder's intervention to protect and assert its claims of privilege against disclosure under the Open Records Law including, but not limited to, prompt reimbursement to the City of all reasonable attorney fees, costs and damages that the City may incur directly or may be ordered to pay by such court.

**IB-27 GENERAL BIDDING INFORMATION**

Bidders are instructed to contact the Contract Administrator designated below for this Project for pre-bid, post-bid and general City bidding information. Bidders can also visit [www.work4denver.com](http://www.work4denver.com) for information, both general and project specific. The Contract Administrator assigned to this project is Diane Mora who can be reached via email at [diane.mora@denvergov.org](mailto:diane.mora@denvergov.org).

**IB-28 PAYMENT PROCEDURE REQUIREMENTS**

Contractor recognizes and agrees that it shall be required to use the Textura® Construction Payment Management System (CPM System) for this Project. All fees associated with the CPM System are to be paid by the Contractor for billings for work performed. Bidders are required, when preparing a bid, to enter the price of the CPM service on the line provided for the service. The fee is all inclusive of all subcontractor, project and subscription fees associated with the CPM system. The bidder will calculate the fee based on a percentage of their total bid, and then should include it on the line item provided in the bid form labeled **“Textura® Construction Payment Management System Fee”**. This expense becomes part of the contract and billable to the City. Textura will invoice the awarded contractor directly. All costs including but not limited to costs associated with training, entering data or utilizing Textura other than the Textura Construction Payment Management System Fee are overhead and shall not be reimbursed by the City. Contractor is responsible for tax on Textura fee. As with other taxes, the City will not reimburse Contractor for this cost and therefore this cost should be included in Contractor's bid. Textura will invoice the awarded contractor directly.

Project Value	Project Fee (GC + Sub Usage)
\$500,000 - \$999,999.99	\$3,250
\$1,000,000 - \$2,999,999.99	\$5,850
\$3,000,000 - \$4,999,999.99	\$9,100
\$5,000,000 - \$9,999,999.99	\$12,220
\$10,000,000 - \$19,999,999.99	\$20,345
\$20,000,000 - \$49,999,999.99	\$32,500
\$50,000,000 - \$99,999,999.99	\$48,750
\$100,000,000 - \$199,999,999.99	\$69,095
\$200,000,000 - \$299,999,999.99	\$85,345
\$300,000,000 - \$399,999,999.99	\$109,720
\$400,000,000 - \$499,999,999.99	\$142,220
\$500,000,000 - \$999,999,999.99	\$162,500
\$1,000,000,000 - \$1,999,999,999.99	\$345,345
\$2,000,000,000 - \$4,999,999,999.99	\$650,000
\$5,000,000,000 - \$9,999,999,999.99	\$1,015,625
\$10,000,000,000 or greater	\$1,503,125

**RULES AND REGULATIONS  
REGARDING  
EQUAL EMPLOYMENT OPPORTUNITY**

Promulgated and adopted by the Manager of Public Works pursuant to and by authority of Article III, Division 2, Chapter 28 of the Revised Municipal Code of the City and County of Denver, and for the purpose of insuring that contractors, subcontractors and suppliers soliciting and receiving compensation for contract work from or through the City and County of Denver provide equal opportunity in employment without regard to race, color, creed, sex, national origin, age, religion, marital status, political opinion or affiliation or mental or physical handicap and meet certain requirements for the hiring, training, promotion, and treatment during employment of members of ethnic groups subject to differential treatment, including persons of African descent (Black), Spanish-surnamed (Hispanic), Asian-American and American Indian Groups.

**RULE I - DEFINITIONS**

- A. "City" means the City and County of Denver.
- B. "Manager" shall mean the Manager of Public Works for the City and County of Denver.
- C. "Contract" means a contract entered into with the City and County of Denver, financed in whole or in part by local resources or funds of the City and County of Denver, for the construction of any public building or prosecution or completion of any public work.
- D. "Contractor" means the original party to a contract with the City and County of Denver, also referred to as the "general" or "prime" contractor.
- E. "Director" means the Director of the Division of Small Business Opportunity.
- F. "Subcontractor" means any person, company, association, partnership, corporation, or other entity, which assumes by subordinate agreement some or all of the obligations of the general or prime contractor.
- G. The phrase "Bidding Specifications" as used in Article III, Division 2 of Chapter 28 of the Revised Municipal Code shall include BID CONDITION, INVITATION TO BID, and NOTICE OF PROPOSAL.
- H. "Affirmative Action Program" means a set of specific and result-oriented procedures or steps to which a contractor commits himself to apply every good faith effort to employ members of ethnic minority groups, to include persons of African descent (Black), Spanish surnamed (Hispanic), Asian-American, American Indians, and persons with mental or physical handicap.
- I. "Division of Small Business Opportunity" means the City agency established pursuant to Article III, Division 1 of Chapter 28 of the Denver Revised Municipal Code.

**RULE II - NOTICE OF HEARING**

When results of conciliation efforts are unsatisfactory to the Manager and he is informed in accordance with Article III, Division 2 of Chapter 28 of the Revised Municipal code that a contractor or subcontractor has apparently failed to meet affirmative action and equal employment opportunity requirements after a reasonable period of notice to correct deficiencies, the Manager will, prior to imposition of any sanctions, afford the general contractor a hearing in order to determine whether the contractor or his subcontractors have failed to comply with the affirmative action and equal employment opportunity requirements of Article III, Division 2 of Chapter 28 of the Revised Municipal Code or of the contract. Written notice of such hearing shall be delivered personally or sent by certified mail, return receipt requested, to the contractor and to any subcontractor involved, at least ten (10) days prior to the date scheduled for the hearing.

### **RULE III - HEARING**

- A. Contractors will appear at hearings and may be represented by counsel, and may present testimony orally and other evidence.
- B. Hearings shall be conducted by one or more hearing examiners designated as such by the Manager.
- C. The Director of the Division of Small Business Opportunity may participate in hearings as a witness.
- D. Hearings shall be held at the place specified in the notice of hearing.
- E. All oral testimony shall be given under oath or affirmation and a record of such proceedings shall be made.
- F. All hearings shall be open to the public.
- G. The hearing officer shall make recommendations to the Manager who shall make a final decision.

### **REGULATIONS**

#### **REGULATION NO. 1 - ORDINANCE:**

The Rules and Regulations of the Manager shall be inserted in the bidding specifications for every contract for which bidding is required.

#### **REGULATION NO. 2 - EXEMPTIONS:**

Each contract and subcontract, regardless of the dollar amount, shall be subject to affirmative action requirements unless specifically exempted in writing individually by the Manager. Exemptions apply only to "affirmative action" in equal employment opportunity, and are not to be construed as condonation in any manner of "discrimination" or "discriminatory practices" in employment because of race, color, creed, sex, age, national origin, religion, marital status, political opinion or mental or physical handicap.

#### **REGULATION NO. 3 - DIRECTOR OF CONTRACT COMPLIANCE:**

The Director of the Division of Small Business Opportunity shall perform the duties assigned to such official by Article III, Division 2 Chapter 28 of the Revised Municipal Code and by the Manager. (1) The Director of the Division of Small Business Opportunity or designated representatives shall inform bidders and contractors of affirmative action procedures, programs, and goals in accordance with the Ordinance at pre-bid and pre-construction conference; (2) make regular on-site inspections; (3) supply contractors and subcontractors with report forms to be completed by them when requested, and furnished to the Director of the Division of Small Business Opportunity; and (4) review payroll records, employment records and practices of general contractors and their subcontractors and suppliers during the performance of any contract. The Director of the Division of Small Business Opportunity shall promptly report apparent affirmative action deficiencies to the Manager.

#### **REGULATION NO. 4 - GOALS AND TIMETABLES:**

In general, goals and timetables should take into account anticipated vacancies and the availability of skills in the market place from which employees should be drawn. In addition, where discrimination in employment by a general contractor or any of his subcontractors is indicated, a corrective action program will take into account the need by the general contractor and his subcontractors to correct past discriminatory practices and reach goals of minority manpower utilization on a timely basis through such recruiting and advertising efforts as are necessary and appropriate.

#### **REGULATION NO. 5 - AWARD OF CONTRACTS:**

It shall be the responsibility of the Director of the Division of Small Business Opportunity to determine the affirmative action capability of bidders, contractors and subcontractors and to recommend to the Manager the award of contracts to those bidders, contractors and subcontractors and suppliers who demonstrate the ability and willingness to comply with the terms of their contract.



**REGULATION NO. 6 - PUBLICATION AND DUPLICATION:**

Copies of these Rules and Regulations as amended by the Manager from time to time, shall as soon as practicable and after Notice being published will be made a part of all City Contracts.

**REGULATION NO. 7 - NOTICE TO PROCEED:**

Prior to issuance of the Notice to Proceed, a sign-off will be required of the Director of the Division of Small Business Opportunity or his designee.

**REGULATION NO. 8 - CONTRACTS WITH SUBCONTRACTORS:**

To the greatest extent possible, the contractor shall make a good faith effort to contract with minority contractors, subcontractors and suppliers for services and supplies by taking affirmative actions, which include but are not limited to the following:

1. Advertise invitations for subcontractor bids in minority community news media.
2. Contact minority contractor organizations for referral of prospective subcontractors.
3. Purchase materials and supplies from minority material suppliers.

**REGULATION NO. 9 - AGENCY REFERRALS:**

It shall be no excuse that the union with which the contractor or subcontractor has an agreement providing for referral, exclusive or otherwise, failed to refer minority employees.

**REGULATION NO. 10 - CLAUSES:**

The Manager shall include the appropriate clauses in every contract and the contractor shall cause to be inserted in every subcontract the appropriate clauses:

1. APPENDIX A: City and County of Denver Equal Opportunity Clause - ALL CONTRACTS funded only with City and County of Denver monies.
2. APPENDIX B: Equal Opportunity Clause (11246) - ALL FEDERAL ASSISTED.
3. APPENDIX C: Section 3 - Assurance of Compliance - HUD ASSISTED PROJECTS.
4. APPENDIX D: Section 3 - Clause - HUD ASSISTED PROJECTS.

All amendments to the appendices shall be included by reference.

**REGULATION NO. 11 - SHOW CAUSE NOTICES:**

When the Manager has reasonable cause to believe that a contractor has violated Article III, Division 2 of Chapter 28 of the Denver Revised Municipal Code, he may issue a notice requiring the contractor to show cause, within fifteen (15) days why enforcement procedures, or other appropriate action to insure compliance, should not be instituted.

**REGULATION NO. 12 - BID CONDITIONS - AFFIRMATIVE ACTION REQUIREMENTS - EQUAL EMPLOYMENT OPPORTUNITY:**

1. APPENDIX E: The Bid Conditions - Affirmative Action Requirements - Equal Employment Opportunity as amended and published by the U.S. Department of Labor Employment Standards Administration, Office of Federal Contract Compliance, shall be inserted verbatim for bidding specification for every non-exempt contract involving the use of Federal funds.
2. APPENDIX F: The Bid Conditions - Affirmative Action Requirements - Equal Employment Opportunity as published by the Department of Public Works, City and County of Denver, shall be inserted verbatim as bidding specifications for every non-exempt contract using City funds.

**CITY AND COUNTY OF DENVER  
DEPARTMENT OF PUBLIC WORKS**

**APPENDIX A**

**CITY AND COUNTY OF DENVER EQUAL OPPORTUNITY CLAUSE -  
ALL CONTRACTS**

1. The Contractor will not discriminate against any employee or applicant for employment because of race, creed, color, sex, age, national origin, religion, marital status, political opinion or affiliation, or mental or physical handicap. The Contractor will take affirmative action to ensure that applicants are employed, and that employees are treated during employment without regard to their race, creed, color, sex, age, national origin, religion, marital status, political opinion or affiliation, or mental or physical handicap. Such action shall include, but not be limited to the following: employment, upgrading, demotion, or transfer; recruitment or recruitment advertising; layoff or termination; rates of pay or other forms of compensation; and selection for training, including apprenticeship. The Contractor agrees to post in conspicuous places, available to employees and applicants for employment, notices to be provided setting forth the provisions of this nondiscrimination clause.
2. The Contractor will, in all solicitations or advertisements for employees placed by or on behalf of the contractor, state that all qualified applicants will receive consideration for employment without regard to race, creed, color, sex, age, national origin, religion, marital status, political opinion or affiliation, or mental or physical handicap.
3. The Contractor will send to each labor union or representative of workers with which he has a collective bargaining agreement or other contract or understanding, a notice to be provided, advising the said labor union or workers' representatives of the contractor's commitments under this section, and shall post copies of the notice in conspicuous places available to employees and applicants for employment.
4. Each Contractor will comply with all provisions of Article III, Division 2 of Chapter 28 of the Revised Municipal Code, and the rules, regulations, and relevant orders of the Manager and the Director.
5. The Contractor will furnish all information and reports required by Article III, Division 2 of Chapter 28 of the Revised Municipal Code, and by rules, regulations and orders of the Manager and Director or pursuant thereto, and will permit access to his books, records, and accounts by the Manager, Director, or their designee for purposes of investigation to ascertain compliance with such rules, regulations, and orders.
6. In the event of the Contractor's noncompliance with the nondiscrimination clauses of this contract or with any of the said rules, regulations or orders, this contract may be canceled, terminated, or suspended in whole or in part and the Contractor may be declared ineligible for further City contracts in accordance with procedures authorized in Article III, Division 2, Chapter 28 of the Revised Municipal Code, or by rules, regulations, or order of the Manager.
7. The Contractor will include Regulation 12, Paragraph 2 and the provisions of paragraphs (1) through (6) in every subcontract of purchase order unless exempted by rules, regulations, or orders of the Manager issued pursuant to Article III, Division 2, Chapter 28 of the Revised Municipal Code, so that such provisions will be binding on each subcontractor or supplier. The Contractor will take such action with respect to any subcontract or purchase order as the administering agency may direct as a means of enforcing such provisions, including sanctions for noncompliance.

The applicant further agrees to be bound by the above equal opportunity clauses with respect to its own employment practices when it participates in City contracts. The Contractor agrees to assist and cooperate actively with the Manager and the Director in obtaining compliance of subcontractors and suppliers with the equal opportunity clause and the rules, regulations and relevant orders of the Manager, and will furnish the Manager and the Director such information as they may require for the supervision of compliance, and will otherwise assist the Manager and Director in the discharge of the City's primary responsibility for securing compliance. The Contractor further agrees to refrain from entering into any contract or contract modification

subject to Article III, Division 2 of Chapter 28 of the Revised Municipal Code with a contractor debarred from, or who has not demonstrated eligibility for, City contracts.

The Contractor will carry out such sanctions and penalties for violation of the equal opportunity clause as may be imposed upon contractors and subcontractors by the Manager and Director. In addition, the Contractor agrees that failure or refusal to comply with these undertakings the Manager may take any or all of the following actions:

- A. Cancellation, termination, or suspension in whole or in part of this contract.
- B. Refrain from extending any further assistance to the applicant under the program with respect to which the failure occurred until satisfactory assurance of future compliance has been received from such applicant.
- C. Refer the case to the City Attorney for appropriate legal proceedings.

**SUBCONTRACTS:** Each prime Contractor or Subcontractor shall include the equal opportunity clause in each of its subcontracts.

**CITY AND COUNTY OF DENVER  
DEPARTMENT OF PUBLIC WORKS**

**APPENDIX F**

**AFFIRMATIVE ACTION REQUIREMENTS**

**EQUAL EMPLOYMENT OPPORTUNITY**

For All Non-Exempt Construction Contracts to Be Awarded by the  
City and County of Denver, Department of Public Works.

**NOTICE**

EACH BIDDER, CONTRACTOR OR SUBCONTRACTOR (HEREINAFTER THE CONTRACTOR) MUST FULLY COMPLY WITH THE REQUIREMENTS OF THESE BID CONDITIONS AS TO EACH CONSTRUCTION TRADE IT INTENDS TO USE ON THIS CONSTRUCTION CONTRACT, AND ALL OTHER CONSTRUCTION WORK (BOTH CITY AND NON-CITY) IN THE DENVER AREA DURING THE PERFORMANCE OF THIS CONTRACT OR SUBCONTRACT. THE CONTRACTOR COMMITS ITSELF TO THE GOALS FOR MINORITY MANPOWER UTILIZATION, AS APPLICABLE, AND ALL OTHER REQUIREMENTS, TERMS AND CONDITION OF THESE BID CONDITIONS BY SUBMITTING A PROPERLY SIGNED BID.

THE CONTRACTOR SHALL APPOINT A COMPANY EXECUTIVE TO ASSUME THE RESPONSIBILITY FOR THE IMPLEMENTATION OF THE REQUIREMENTS, TERMS AND CONDITIONS OF THESE BID CONDITIONS.

*/s/* \_\_\_\_\_

Executive Director of Public Works  
City and County of Denver

**A. REQUIREMENTS - AN AFFIRMATIVE ACTION PLAN:**

Contractors shall be subject to the provisions and requirements of these bid conditions including the goals and timetables for minority\* and female utilization, and specific affirmative action steps set forth by the Division of Small Business Opportunity (DSBO). The contractor's commitment to the goals for minority, and female utilization as required constitutes a commitment that it will make every good faith effort to meet such goals.

**1. GOALS AND TIMETABLES:**

The goals and timetables for minority and female participation, expressed in percentage terms for the contractor's aggregate workforce in each trade are as follows:

GOALS FOR MINORITY PARTICIPATION FOR EACH TRADE	GOALS FOR FEMALE PARTICIPATION FOR EACH TRADE
From January 1, 1982 to Until Further Notice	From January 1, 1982 to Until Further Notice
<b>21.7% - 23.5%</b>	<b>6.9%</b>

The goals for minority and female utilization above are expressed in terms of hours of training and employment as a proportion of the total number of hours to be worked by the contractor's aggregate workforce, which includes all supervisory personnel, in each trade, on all projects for the City and County of Denver during the performance of its contract (i.e., The period beginning with the first day of work on the City and County of Denver funded construction contract and ending with the last day of work).

The hours of minority and female employment and training must be substantially uniform throughout the length of the contract in each trade and minorities and females must be employed evenly on each of a contractor's projects. Therefore, the transfer of minority or female employees from contractor to contractor or from project to project for the purpose of meeting the contractor's goals shall be a violation of these Bid Conditions.

If the Contractor counts the nonworking hours of apprentices they must be employed by the Contractor during the training period; the Contractor must have made a commitment to employ apprentices at the completion of their training subject to the availability of employment opportunities; and the apprentices must be trained pursuant to training programs approved by the Bureau of Apprenticeship and Training.

\* "Minority" is defined as including, Blacks, Spanish Surname Americans, Asian Americans, and American Indians, and includes both men and minority women.

**2. SPECIFIC AFFIRMATIVE ACTION STEPS:**

No contractor shall be found to be in noncompliance solely on account of its failure to meet its goals, but will be given an opportunity to demonstrate that the contractor has instituted all the specific affirmative action steps specified and has made every good faith effort to make these steps work toward the attainment of its goals within the timetables, all to the purpose of expanding minority and female utilization in its aggregate workforce. A contractor, who fails to comply with its obligation under the Equal Opportunity Clause of its contract and fails to achieve its commitments to the goals for minority and female utilization has the burden of proving that it has engaged in an Affirmative Action Program directed at increasing minority and female utilization and that such efforts were at least as extensive and as specific as the following:

- a. The Contractor should have notified minority and female organizations when employment opportunities were available and should have maintained records of the organization's response.

- b. The Contractor should have maintained a file of the names and addresses of each minority and female referred to it by any individual or organization and what action was taken with respect to each such referred individual, and if the individual was not employed by the Contractor, the reasons. If such individual was sent to the union hiring hall for referral and not referred back by the union or if referred, not employed by the Contractor, the file should have documented this and their reasons.
- c. The Contractor should have promptly notified the Department of Public Works, and the Division of Small Business Opportunity when the union or unions with which the Contractor has collective bargaining agreements did not refer to the contractor a minority or female sent by the contractor, or when the Contractor has other information that the union referral process has impeded efforts to meet its goals.
- d. The Contractor should have disseminated its EEO policy within its organization by including it in any employee handbook or policy manual; by publicizing it in company newspapers and annual reports and by advertising such policy at reasonable intervals in union publications. The EEO policy should be further disseminated by conducting staff meetings to explain and discuss the policy; by posting of the policy; and by review of the policy with minority and female employees.
- e. The Contractor should have disseminated its EEO policy externally by informing and discussing it with all recruitment sources; by advertising in news media, specifically including minority and female news media; and by notifying and discussing it with all subcontractors.
- f. The Contractor should have made both specific and reasonably recurrent written and oral recruitment efforts. Such efforts should have been directed at minority and female organizations, schools with substantial minority and female enrollment, and minority and female recruitment and training organizations within the Contractor's recruitment area.
- g. The Contractor should have evidence available for inspection that all tests and other selection techniques used to select from among candidates for hire, transfer, promotion, training, or retention are being used in a manner that does not violate the OFCCP Testing Guidelines in 41 CFR Part 60-3.
- h. The Contractor should have made sure that seniority practices and job classifications do not have a discriminatory effect.
- i. The Contractor should have made certain that all facilities are not segregated by race.
- j. The Contractor should have continually monitored all personnel activities to ensure that its EEO policy was being carried out including the evaluation of minority and female employees for promotional opportunities on a quarterly basis and the encouragement of such employees to seek those opportunities.
- k. The Contractor should have solicited bids for subcontracts from available minority and female subcontractors engaged in the trades covered by these Bid Conditions, including circulation of minority and female contractor associations.

NOTE: The Director and the Division of Small Business Opportunity will provide technical assistance on questions pertaining to minority and female recruitment sources, minority and female community organizations, and minority and female news media upon receipt of a request for assistance from a contractor.

**3. NON - DISCRIMINATION:**

In no event may a contractor utilize the goals and affirmative action steps required in such a manner as to cause or result in discrimination against any person on account of race, color, religion, sex, marital status, national origin, age, mental or physical handicap, political opinion or affiliation.

**4. COMPLIANCE AND ENFORCEMENT:**

In all cases, the compliance of a contractor will be determined in accordance with its obligations under the terms of these Bid Conditions. All contractors performing or to perform work on projects subject to these Bid Conditions hereby agree to inform their subcontractors in writing of their respective obligations under the terms and requirements of these Bid Conditions, including the provisions relating to goals of minority and female employment and training.

**B. CONTRACTORS SUBJECT TO THESE BID CONDITIONS:**

In regard to these Bid Conditions, if the Contractor meets the goals set forth therein or can demonstrate that it has made every good faith effort to meet these goals, the Contractor shall be presumed to be in compliance with Article III, Division 2 of Chapter 28 of the Revised Municipal Code, the implementing regulations and its obligations under these Bid Conditions. In the event, no formal sanctions or proceedings leading toward sanctions shall be instituted unless the contracting or administering agency otherwise determines that the contractor is violating the Equal Opportunity Clause.

1. Where the Office of Contract Compliance finds that a contractor failed to comply with the requirements of Article III, Division 2 of Chapter 28 of the Revised Municipal Code or the implementing regulations and the obligations under these Bid Conditions, and so informs the Manager, the Manager shall take such action and impose such sanctions, which include suspension, termination, cancellation, and debarment, as may be appropriate under the Ordinance and its regulations. When the Manager proceeds with such formal action it has the burden of proving that the Contractor has not met the goals contained in these Bid Conditions. The Contractor's failure to meet its goals shall shift to it the requirement to come forward with evidence to show that it has met the good faith requirements of these Bid Conditions.
2. The pendency of such proceedings shall be taken into consideration by the Department of Public Works in determining whether such contractor can comply with the requirements of Article III, Division 2 of Chapter 28 of the Revised Municipal Code, and is therefore a "responsible prospective contractor".
3. The Division of Small Business Opportunity shall review the Contractor's employment practices during the performance of the contract. If the Division of Small Business Opportunity determines that the Contractor's Affirmative Action Plan is no longer an acceptable program, the Director shall notify the Manager.

**C. OBLIGATIONS APPLICABLE TO CONTRACTORS:**

It shall be no excuse that the union with which the Contractor has a collective bargaining agreement providing for exclusive referral failed to refer minority or female employees. Discrimination in referral for employment, even if pursuant to provisions of a collective bargaining agreement, is prohibited by the National Labor Relations Act, as amended, Title VI of the Civil Rights Act of 1964, as amended, and Article III, Division 2 of Chapter 28 of the Revised Municipal Code. It is the policy of the Department of Public Works that contractors have a responsibility to provide equal employment opportunity, if they wish to participate in City and County of Denver contracts. To the extent they have delegated the responsibility for some of their employment practices to a labor organization and, as a result, are prevented from meeting their obligations pursuant to Article III, Division 2, Chapter 28 of the Revised Municipal Code, such Contractors cannot be considered to be in compliance with Article III, Division 2, Chapter 28 of the Revised Municipal Code, or its implementing rules and regulations.

**D. GENERAL REQUIREMENTS:**

Contractors are responsible for informing their subcontractors in writing regardless of tier, as to their respective obligations. Whenever a Contractor subcontracts a portion of work in any trade covered by these Bid Conditions, **it shall include these Bid Conditions in such subcontracts and each subcontractor shall**

**be bound by these Bid Conditions to the full extent as if it were the prime contractor.** The Contractor shall not, however, be held accountable for the failure of its subcontractors to fulfill their obligations under these Bid Conditions. However, the prime contractor shall give notice to the Director of any refusal or failure of any subcontractor to fulfill the obligations under these Bid Conditions. A subcontractor's failure to comply will be treated in the same manner as such failure by a prime contractor.

1. Contractors hereby agree to refrain from entering into any contract or contract modification subject to Article III, Division 2, Chapter 28 of the Revised Municipal Code with a contractor debarred from, or who is determined not to be a "responsive" bidder for the City and County of Denver contracts pursuant to the Ordinance.
2. The Contractor shall carry out such sanctions and penalties for violation of these Bid Conditions and the Equal Opportunity Clause including suspension, termination and cancellation of existing subcontracts and debarment from future contracts as may be ordered by the Manager pursuant to Article III, Division 2, Chapter 28 of the Revised Municipal Code and its implementing regulations.
3. Nothing herein is intended to relieve any contractor during the term of its contract from compliance with Article III, Division 2, Chapter 28 of the Revised Municipal Code, and the Equal Opportunity Clause of its contract with respect to matters not covered in these Bid Conditions.
4. Contractors must keep such records and file such reports relating to the provisions of these Bid Conditions as shall be required by the Office of Contract Compliance.
5. Requests for exemptions from these Bid Conditions must be made in writing, with justification, to the Manager of Public Works, 201 W. Colfax, Dept. 608, Denver, Colorado 80202, and shall be forwarded through and with the endorsement of the Director.



**CITY AND COUNTY OF DENVER  
DEPARTMENT OF PUBLIC WORKS**

**CONTRACT NO. 201843656**

**GENERAL SANITARY - CHERRY CREEK IMPROVEMENTS**

**CONTRACT**

**THIS CONTRACT AND AGREEMENT**, made and entered into by and between the City and County of Denver, a municipal corporation of the State of Colorado, hereinafter referred to as the "City," party of the first part, and

**Insituform Technologies, LLC  
17988 Edison Avenue  
Chesterfield, MO 63005**

, hereinafter referred to as the "Contractor," party of the second part,

**WITNESSETH**, commencing on **August 1, 2018**, and for at least three (3) days the City advertised that sealed bids would be received for furnishing all labor, tools, supplies, equipment, materials, and everything necessary and required for the following:

<p><b>CONTRACT NO. 201843656</b></p> <p><b>GENERAL SANITARY - CHERRY CREEK IMPROVEMENTS</b></p>
---

**WHEREAS**, bids pursuant to said advertisement have been received by the Manager of Public Works, who has recommended that a Contract for said work be made and entered into with the above named Contractor who was the lowest, responsive, qualified bidder therefore, and

**WHEREAS**, said Contractor is now willing and able to perform all of said work in accordance with said advertisement and its bid.

**NOW THEREFORE**, in consideration of the compensation to be paid the Contractor, the mutual agreements hereinafter contained, and subject to the terms hereinafter stated, it is mutually agreed as follows:

**1. CONTRACT DOCUMENTS**

It is agreed by the parties hereto that the following list of documents, instruments, technical specifications, plans, drawings and other materials which are attached hereto and bound herewith, incorporated herein by reference or otherwise referenced in these documents constitute and shall be referred to either as the "Contract Documents" or the "Contract," and all of said documents, instruments, technical specifications, Plans, Drawings and other materials taken together as a whole constitute the Contract between the parties hereto, and they are as fully a part of this agreement as if they were set out verbatim and in full herein:

*Advertisement of Notice of Invitation for Bids  
Instructions to Bidders  
Commitment to M/WBE Participation  
Article III, Divisions 1, 2, and 3 of Chapter 28, D.R.M.C.  
Bid Bond  
Addenda (as applicable)*

*Equal Employment Opportunity Provisions (Appendix A and Appendix F)*  
*Bid Form*  
*Contract Form*  
*General Contract Conditions*  
*Special Contract Conditions*  
*Performance and Payment Bond*  
*Notice to Apparent Low Bidder*  
*Notice to Proceed*  
*Contractor's Certification of Payment Form*  
*Final/Partial Lien Release Form*  
*Certificate of Contract Release*  
*Change Orders (as applicable)*  
*Federal Requirements (as applicable)*  
*Prevailing Wage Rate Schedule(s)*  
*Technical Specifications*  
*Contract Drawings*  
*Accepted Shop Drawings*

**2. SCOPE OF WORK**

The Contractor agrees to and shall furnish all labor, tools, supplies, equipment, materials and everything necessary for and required to do, perform and complete all of the Work described, drawn, set forth, shown and included in said Contract Documents.

**3. TERMS OF PERFORMANCE**

The Contractor agrees to undertake the performance of the Work under this Contract within ten (10) days after being notified to commence work by issuance of a Notice to Proceed in substantially the form contained herein from the Manager and agrees to fully complete said Work within **210** (Two Hundred Ten Calendar Days) consecutive calendar days from the effective date of said Notice, plus such extension or extensions of time as may be granted in accordance with the provisions of the General Contract Conditions and any applicable Special Contract Conditions.

**4. TERMS OF PAYMENT**

The City agrees to pay the Contractor for the performance of all of the Work required under this Contract, and the Contractor agrees to accept as the Contractor's full and only compensation therefore, such sum or sums of money as may be proper in accordance with the price or prices set forth in the Contractor's Bid Form hereto attached and made a part hereof for **bid item numbers 3-7a through 50-1 (Twenty-Five [25] total bid items)**, the total estimated cost thereof being **Two Million One Hundred Ninety-Five Thousand Seven Hundred Sixty-Nine Dollars and Fifty Cents (\$2,195,769.50)**. Adjustments to said Contract Amount and payment of amounts due hereunder shall be made in accordance with the provisions of the General Contract Conditions and any applicable Special Contract Conditions.

**5. NO DISCRIMINATION IN EMPLOYMENT**

In connection with the performance of work under this contract, the Contractor may not refuse to hire, discharge, promote or demote, or discriminate in matters of compensation against any person otherwise qualified, solely because of race, color, religion, national origin, gender, age, military status, sexual orientation, gender identity or gender expression, marital status, or physical or mental disability. The Contractor shall insert the foregoing provision in all subcontracts.

**6. COMPLIANCE WITH M/WBE REQUIREMENT**

This Contract is subject to all applicable provisions of Divisions 1 and 3 of Article III, of Chapter 28, Denver Revised Municipal Code (D.R.M.C.), designated as Sections 28-31 – 28-36 and 28-52 – 28-90 D.R.M.C. and referred to in this Contract as the "M/WBE Ordinance". Without limiting the general applicability of the foregoing, the Contractor acknowledges its continuing duty, pursuant to Sections 28-72, 28-73 and 28-75 of the D.R.M.C., to maintain throughout the duration of this Contract, compliance with the level of minority and Woman business enterprise participation, upon which the City approved the award of this Contract to the Contractor and the Contractor further acknowledges that failure to maintain such participation

commitments or otherwise comply with the requirements of the M/WBE Ordinance shall subject the Contractor to sanctions in accordance with Section 28-77 of the D.R.M.C. Nothing contained in this provision or in the M/WBE Ordinance shall negate the City's right to prior approval of subcontractors, or substitutes therefore, under this Contract

**7. WAGE RATE REQUIREMENTS**

In performance of all Work hereunder, the Contractor agrees to comply with and be bound by all requirements and conditions of the City's Payment of Prevailing Wages Ordinance, Sections 20-76 through 20-79, D.R.M.C. and any determinations made by the City pursuant thereto.

**8. APPLICABILITY OF LAWS**

The Agreement between the Contractor and the City shall be deemed to have been made in the City and County of Denver, State of Colorado and shall be subject to, governed by, and interpreted and construed by or in accordance with the laws of the State of Colorado and the Charter, Revised Municipal Code, Rules, Regulations, Executive Orders and fiscal rules of the City. As such, the Contractor shall at all times comply with the provisions of the Charter, Revised Municipal Code, Rules, Regulations, Executive Orders and fiscal rules of the City, and those State of Colorado and Federal Laws, Rules and Regulations, which in any manner limit, control or apply to the actions or operations of the Contractor, any subcontractors, employees, agents or servants of the Contractor engaged in the Work or affecting the materials and equipment used in the performance of the Work, as the same may be, from time to time, promulgated, revised or amended. The Charter and Revised Municipal Code of the City and County of Denver, as the same may be amended from time to time, are hereby expressly incorporated into this Agreement as if fully set out herein by this reference.

**9. APPROPRIATION**

The amount of money, which has been appropriated and encumbered for the purpose of this contract, to date, is equal to or in excess of the Contract Amount. The Manager, upon reasonable written request, will advise the Contractor in writing of the total amount of appropriated and encumbered funds, which remain available for payment for all Work under the Contract.

The issuance of any change order or other form or order or directive by the City which would cause the aggregate payable under the contract to exceed the amount appropriated for the contract is expressly prohibited. In no event shall the issuance of any change order or other form of order or directive by the City be considered valid or binding if it requires additional compensable work to be performed, which work will cause the aggregate amount available under the Contract to exceed the amount appropriated and encumbered for this Contract, unless and until such time as the Contractor has been advised in writing by the Manager that a lawful appropriation, sufficient to cover the entire cost of such additional work, has been made.

It shall be the responsibility of the Contractor to verify that the amounts already appropriated for this Contract are sufficient to cover the entire cost of such work, and any work undertaken or performed in excess of the amount appropriated is undertaken or performed in violation of the terms of this contract, without the proper authorization for such work, and at the Contractor's own risk.

**10. APPROVALS**

In the event this Contract calls for the payment by the City of five hundred thousand dollars (\$500,000.00) or more, approval by the Board of Councilmen of the City and County of Denver, acting by ordinance, in accordance with Section 3.2.6 of the Charter of the City and County of Denver, is and shall be an express condition precedent to the lawful and binding execution and effect and performance of this contract.

**11. ASSIGNMENT**

The Contractor shall not assign any of its rights, benefits, obligations or duties under this Contract except upon the prior written consent and approval of the Manager to such assignment.

**12. DISPUTES RESOLUTION PROCESS**

It is the express intention of the parties to this Contract that all disputes of any nature whatsoever regarding the Contract including, but not limited to, any claims for compensation or damages arising out of breach or default under this Contract, shall be resolved by administrative hearing pursuant to the provisions of Section 56-106, D.R.M.C., or, as applicable, Section 28-33 D.R.M.C. for Minority and Woman Business Enterprise

disputes. The Contractor expressly agrees that this dispute resolution process is the only dispute resolution mechanism that will be recognized by the parties for any claims put forward by the Contractor, notwithstanding any other claimed theory of entitlement on the part of the Contractor or its subcontractors or suppliers.

**13. CONTRACT BINDING**

It is agreed that this Contract shall be binding on and inure to the benefit of the parties hereto, their heirs, executors, administrators, assigns and successors.

**14. PARAGRAPH HEADINGS**

The captions and headings set forth herein are for convenience of reference only and shall not be construed so as to define or limit the terms and provisions hereof.

**15. SEVERABILITY**

It is understood and agreed by the parties hereto that, if any part, term, or provision of this Contract, except for the provisions of this Contract requiring prior appropriation and limiting the total amount to be paid by the City, is by the courts held to be illegal or in conflict with any law of the State of Colorado, the validity of the remaining portions or provisions shall not be affected, and the rights and obligations of the parties shall be construed and enforced as if the Contract did not contain the particular part, term or provision held to be invalid.

**16. ELECTRONIC SIGNATURES AND ELECTRONIC RECORDS:**

Contractor consents to the use of electronic signatures by the City. The Agreement, and any other documents requiring a signature hereunder, may be signed electronically by the City in the manner specified by the City. The Parties agree not to deny the legal effect or enforceability of the Agreement solely because it is in electronic form or because an electronic record was used in its formation. The Parties agree not to object to the admissibility of the Agreement in the form of an electronic record, or a paper copy of an electronic document, or a paper copy of a document bearing an electronic signature, on the ground that it is an electronic record or electronic signature or that it is not in its original form or is not an original.

**Contract Control Number:**

IN WITNESS WHEREOF, the parties have set their hands and affixed their seals at Denver, Colorado as of

SEAL

**CITY AND COUNTY OF DENVER**

ATTEST:

By \_\_\_\_\_

\_\_\_\_\_

APPROVED AS TO FORM:

REGISTERED AND COUNTERSIGNED:

By \_\_\_\_\_

By \_\_\_\_\_

By \_\_\_\_\_



IN WITNESS WHEREOF, the parties have executed this agreement and affixed their seals at Denver, Colorado as of the day first above written.

**Contract Control Number: 201843656**

**Vendor Name: Insituform Technologies, LLC**

By: Whitney Schulte

Name: Whitney Schulte  
Contracting & Attesting Officer  
(please print)

Title: \_\_\_\_\_  
(please print)

**ATTEST: [if required]**

By: Christanda Adkins

Name: Christanda Adkins  
Contracting & Attesting Officer  
(please print)

Title: \_\_\_\_\_  
(please print)



**CITY AND COUNTY OF DENVER  
DEPARTMENT OF PUBLIC WORKS**

**General Contract Conditions**

**INDEX**

<b>TITLE 1</b>		
<b>DEFINITIONS</b>	.....	<b>1</b>
101	CITY .....	1
102	CONTRACT .....	1
103	CONTRACT AMOUNT .....	1
104	CONTRACT DOCUMENTS .....	1
105	CONTRACT TIME .....	1
106	CONTRACTOR .....	2
107	CONTRACTOR PERSONNEL .....	2
108	DAYS .....	2
109	DEPUTY MANAGER .....	2
110	DESIGNER .....	2
111	FINAL COMPLETION .....	2
112	MANAGER .....	3
113	PRODUCT DATA .....	3
114	PROJECT .....	3
115	PROJECT MANAGER .....	3
116	SAMPLES .....	3
117	SHOP DRAWINGS .....	3
118	SUBCONTRACTOR .....	3
119	SUBSTANTIAL COMPLETION .....	3
120	SUPPLIER .....	4
121	WORK .....	4
 <b>TITLE 2</b>		
<b>CITY ADMINISTRATIVE ORGANIZATIONS; LINE OF AUTHORITY</b>	.....	<b>5</b>
201	DEPARTMENT OF AVIATION .....	5
202	MANAGER OF AVIATION .....	5
203	DEPARTMENT OF PUBLIC WORKS .....	5
204	MANAGER OF PUBLIC WORKS .....	5
205	BUILDING INSPECTION .....	5
206	ZONING .....	5
207	DIVISION OF SMALL BUSINESS OPPORTUNITY .....	6
208	CITY AUDITOR .....	6
209	MANAGER OF FINANCE .....	6
210	CITY ATTORNEY .....	6
211	OFFICE OF RISK MANAGEMENT .....	6
212	CITY'S CONTRACT ADMINISTRATION LINE OF AUTHORITY .....	6
213	CITY'S COMMUNICATION WITH THE CONTRACTOR .....	7

<b>TITLE 3</b>		
<b>CONTRACTOR PERFORMANCE AND SERVICES.....</b>		<b>8</b>
301 CONSIDERATION		
(CONTRACTOR'S PROMISE OF PERFORMANCE).....		8
302 NOTICE TO PROCEED AND COMPLETION OF THE WORK .....		8
303 EXACT CONTRACTOR PERFORMANCE .....		8
304 SUBSTITUTED PERFORMANCE.....		8
305 WORK PERFORMED UNDER ADVERSE		
WEATHER CONDITIONS.....		9
306 WORKING HOURS AND SCHEDULE .....		9
307 CONTRACTOR'S SUPERINTENDENT .....		10
308 COMMUNICATIONS .....		10
309 CONTRACTOR SUBMITTALS		
AND OTHER WRITTEN COMMUNICATIONS TO THE CITY.....		10
310 COMPETENCE OF CONTRACTOR'S WORK FORCE .....		11
311 NO EMPLOYMENT OF ILLEGAL ALIENS		
TO PERFORM WORK UNDER THE CONTRACT .....		11
312 CONDUCT OF CONTRACTOR'S PERSONNEL .....		12
313 SUGGESTIONS TO CONTRACTOR.....		12
314 WORK FORCE .....		12
315 CONSTRUCTION MACHINES AND STANDBY EQUIPMENT .....		13
316 CUTTING AND PATCHING THE WORK .....		13
317 PERMITS AND LICENSES .....		13
318 CONSTRUCTION SURVEYS .....		14
319 PRESERVATION OF PERMANENT		
LAND SURVEY CONTROL MARKERS .....		14
320 TRADEMARKS, COPYRIGHTS AND PATENTED DEVICES,		
MATERIALS, AND PROCESSES .....		15
321 PROJECT SIGNS.....		15
322 PUBLICITY AND ADVERTISING.....		16
323 TAXES .....		16
324 DOCUMENTS AND SAMPLES AT THE SITE .....		17
325 CLEANUP DURING CONSTRUCTION.....		17
326 SANITARY FACILITIES.....		18
327 POWER, LIGHTING, HEATING, VENTILATING,		
AIR CONDITIONING AND WATER SERVICES .....		18
<b>TITLE 4</b>		
<b>CONTRACT DOCUMENTS (DRAWINGS AND TECHNICAL SPECIFICATIONS).....</b>		<b>19</b>
401 CONTRACT DOCUMENTS - REVIEW AND INTERPRETATION.....		19
402 OWNERSHIP OF CONTRACT DRAWINGS		
AND TECHNICAL SPECIFICATIONS.....		20
403 CONTRACT DRAWINGS AND TECHNICAL SPECIFICATIONS		
ISSUED TO THE CONTRACTOR .....		20
404 REQUESTS FOR INFORMATION OR CLARIFICATION .....		21
405 SHOP DRAWINGS, PRODUCT DATA AND SAMPLES .....		21
406 SUBSTITUTION OF MATERIALS AND EQUIPMENT .....		22
<b>TITLE 5</b>		
<b>SUBCONTRACTS .....</b>		<b>24</b>
501 SUBCONTRACTS.....		24
502 SUBCONTRACTOR ACCEPTANCE .....		24
<b>TITLE 6</b>		
<b>TIME OF COMMENCEMENT AND COMPLETION .....</b>		<b>27</b>
601 BEGINNING, PROGRESS AND TIME OF COMPLETION .....		27
602 LIQUIDATED DAMAGES; ADMINISTRATIVE COSTS;		



ACTUAL DAMAGES.....	27
603 DELAY DAMAGES.....	28
<b>TITLE 7</b>	
<b>COOPERATION, COORDINATION AND RATE OF PROGRESS .....</b>	<b>29</b>
701 COOPERATION WITH OTHER WORK FORCES .....	29
702 COORDINATION OF THE WORK.....	30
703 COORDINATION OF PUBLIC CONTACT.....	30
704 RATE OF PROGRESS .....	30
<b>TITLE 8</b>	
<b>PROTECTION OF PERSONS AND PROPERTY .....</b>	<b>32</b>
801 SAFETY OF PERSONS .....	32
802 PROTECTIVE DEVICES AND SAFETY PRECAUTIONS .....	33
803 PROTECTION OF PROPERTY AND WORK IN PROGRESS .....	33
804 PROTECTION OF MUNICIPAL, PUBLIC SERVICE OR PUBLIC UTILITY SYSTEMS .....	34
805 PROTECTION OF STREET AND ROAD SYSTEM .....	35
806 PROTECTION OF DRAINAGE WAYS.....	36
807 PROTECTION OF THE ENVIRONMENT .....	36
808 HAZARDOUS AND EXPLOSIVE MATERIALS OR SUBSTANCES.....	37
809 ARCHAEOLOGICAL AND HISTORICAL DISCOVERIES .....	37
<b>TITLE 9</b>	
<b>COMPENSATION .....</b>	<b>38</b>
901 CONSIDERATION (CITY'S PROMISE TO PAY).....	38
902 PAYMENT PROCEDURE .....	38
903 SCHEDULE OF VALUES IN LUMP SUM CONTRACTS .....	39
904 UNIT PRICE CONTRACTS.....	39
905 PROGRESS PERIOD.....	39
906 APPLICATIONS FOR PAYMENT.....	40
907 RELEASES AND CONTRACTORS CERTIFICATIONS OF PAYMENT .....	41
908 RETAINAGE .....	41
909 ADDITIONAL WITHHOLDING OF PROGRESS PAYMENTS .....	42
910 FINAL ESTIMATE AND PAYMENT.....	43
911 ACCOUNTING OF COSTS AND AUDIT .....	43
<b>TITLE 10</b>	
<b>WAGE .....</b>	<b>45</b>
1001 PREVAILING WAGE ORDINANCE.....	45
1002 POSTING OF THE APPLICABLE WAGE RATES.....	45
1003 RATE AND FREQUENCY OF WAGES PAID.....	45
1004 REPORTING WAGES PAID .....	45
1005 FAILURE TO PAY PREVAILING WAGES .....	46
<b>TITLE 11</b>	
<b>CHANGES IN THE WORK, CONTRACT PRICE OR CONTRACT TIME .....</b>	<b>47</b>
1101 CHANGE ORDER.....	47
1102 CITY INITIATED CHANGES .....	47
1103 CONTRACTOR CHANGE REQUEST.....	48
1104 ADJUSTMENT TO CONTRACT AMOUNT .....	51
1105 TIME EXTENSIONS.....	54
<b>TITLE 12</b>	
<b>CONTRACTOR CLAIMS FOR ADJUSTMENT AND DISPUTES.....</b>	<b>56</b>
1201 NOTICE OF INTENT TO CLAIM.....	56

1202	SUBMITTAL OF CLAIMS .....	56
1203	WAIVER OF CLAIMS .....	58
<b>TITLE 13</b>		
<b>DISPUTES .....</b>		<b>59</b>
1301	DISPUTES .....	59
<b>TITLE 14</b>		
<b>SITE CONDITIONS .....</b>		<b>60</b>
1401	DIFFERING SITE CONDITIONS.....	60
1402	SITE INSPECTIONS AND INVESTIGATIONS.....	60
<b>TITLE 15</b>		
<b>PERFORMANCE AND PAYMENT BONDS .....</b>		<b>62</b>
1501	SURETY BONDS .....	62
1502	PERFORMANCE BOND .....	62
1503	PAYMENT BOND.....	62
<b>TITLE 16</b>		
<b>INSURANCE AND INDEMNIFICATION .....</b>		<b>63</b>
1601	INSURANCE .....	63
1602	DEFENSE AND INDEMNIFICATION .....	63
<b>TITLE 17</b>		
<b>INSPECTION AND DEFECTS .....</b>		<b>64</b>
1701	CONSTRUCTION INSPECTION BY THE CITY .....	64
1702	AUTHORITY OF INSPECTORS .....	64
1703	OBSERVABLE DEFECTS.....	64
1704	DEFECTS - UNCOVERING WORK .....	64
1705	LATENT DEFECTS .....	65
1706	REMOVAL OF DEFECTIVE MATERIALS AND WORK .....	65
<b>TITLE 18</b>		
<b>WARRANTIES, GUARANTEES AND CORRECTIVE WORK.....</b>		<b>66</b>
1801	CONTRACTOR'S WARRANTIES, GUARANTEES AND CORRECTION OF WORK .....	66
1802	PERFORMANCE DURING WARRANTY PERIOD .....	67
<b>TITLE 19</b>		
<b>SUBSTANTIAL COMPLETION OF THE WORK.....</b>		<b>69</b>
1901	CONTRACTOR'S NOTICE OF SUBSTANTIAL COMPLETION .....	69
1902	INSPECTION AND PUNCH LIST .....	69
1903	CERTIFICATE OF SUBSTANTIAL COMPLETION .....	69
1904	RIGHT OF EARLY OCCUPANCY OR USE .....	69
<b>TITLE 20</b>		
<b>FINAL COMPLETION AND ACCEPTANCE OF THE WORK.....</b>		<b>71</b>
2001	CLEAN-UP UPON COMPLETION.....	71
2002	FINAL COMPLETION AND ACCEPTANCE OF THE WORK .....	71
2003	FINAL SETTLEMENT.....	71
<b>TITLE 21</b>		
<b>SUSPENSION OF WORK.....</b>		<b>74</b>
2101	SUSPENSION OF WORK.....	74
2102	SUSPENSION OF THE WORK FOR THE CITY'S CONVENIENCE .....	74
2103	SUSPENSION BECAUSE OF ORDER OF CITY, STATE	

OR FEDERAL COURT OR AGENCY .....	75
2104 SUSPENSION RESULTING FROM CONTRACTOR'S FAILURE TO PERFORM.....	75
<b>TITLE 22</b>	
<b>CITY'S RIGHT TO TERMINATE THE CONTRACT .....</b>	<b>76</b>
2201 TERMINATION OF CONTRACT FOR CAUSE .....	76
2202 TERMINATION OF CONTRACT FOR CONVENIENCE OF THE CITY .....	77
<b>TITLE 23</b>	
<b>MISCELLANEOUS PROVISIONS .....</b>	<b>80</b>
2301 PARTIES TO THE CONTRACT.....	80
2302 FEDERAL AID PROVISIONS.....	80
2303 NO WAIVER OF RIGHTS .....	80
2304 NO THIRD PARTY BENEFICIARY .....	80
2305 GOVERNING LAW; VENUE.....	81
2306 ABBREVIATIONS .....	81
2307 STATUTE OF LIMITATIONS IN C.R.S. § 13-80-102(1)(h) .....	81

**CITY AND COUNTY OF DENVER**  
**DEPARTMENT OF PUBLIC WORKS**  
**SPECIAL CONTRACT CONDITIONS**

**SC-1 CONSTRUCTION SPECIFICATIONS**

Except as amended herein or in the attached Technical Specifications, all Work performed under the terms of this Contract shall be governed by the applicable provisions of the following latest editions:

City and County of Denver:

*Standard Specifications for Construction, GENERAL CONTRACT CONDITIONS,*  
2011 Edition.

*Transportation Standards and Details for the Engineering Division*

*City and County of Denver Traffic Standard Drawings*

Wastewater Management Division

– *Standard Detail Drawings*

– *Public Works Wastewater Capital Projects Management Standard Construction Specifications*

Colorado Department of Transportation:

*Standard Specifications for Road and Bridge Construction*  
(Sections 200 through 700 of the 2011 Edition)

Federal Highway Administration:

*Manual on Uniform Traffic Control Devices for Streets & Highways* (MUTCD)

Building & Fire Codes:

*Building Code of the City and County of Denver*

(International Building Code 2015 Series, City and County of Denver Amendments 2016)

*National Fire Protection Association Standards*

(As referenced in the Building Code of the City and County of Denver)

The aforementioned City and County of Denver documents are available for review at the Capital Projects Management Office, 201 W. Colfax Ave., Dept. 506, (5<sup>th</sup> floor), Denver, CO 80202. The *Standard Specifications for Construction, GENERAL CONTRACT CONDITIONS* is available at: <https://www.denvergov.org/content/denvergov/en/contract-administration/contractor-resources.html>. *Transportation Standards and Details for the Engineering Division* and the Wastewater Management Division – *Standard Detail Drawings*, are available at <http://www.denvergov.org>.

The “*Colorado Department of Transportation Standard Specifications for Road and Bridge Construction*” is available for review on CDOT’s website at <http://www.coloradodot.info/> and can be purchased from the Colorado Department of Transportation.

The *Manual on Uniform Traffic Control Devices for Streets & Highways* is available for review at the Federal Highway Administration Website at: [www.fhwa.dot.gov](http://www.fhwa.dot.gov), The FHWA website also contains purchasing information.

**SC-2 DEPUTY MANAGER / CITY ENGINEER**

General condition 109 DEPUTY MANAGER is hereby deleted in its entirety and replaced with the following:

The “Deputy Manager” means the official who reports directly to the Manager and exercises supervisory responsibility in the City agency defined in Title 2 herein that is responsible for the Project. The Manager hereby designates the City Engineer as the Deputy Manager for purposes of this Contract. The City Engineer shall have responsibility for this Project and shall undertake all duties, responsibilities, rights and authority, including specific actions and decisions, delegated to the Deputy Manager under the various terms and conditions of this Contract.

**SC-3 ENGINEERING DIVISION / CITY ENGINEER**

The Engineering Division is a unit of the Department of Public Works and is supervised by the City Engineer, who is subordinate to the Manager of Public Works. This Division is responsible for the planning, design, construction, operation and maintenance of all of the City's transportation facilities and the planning, design and construction of all of the City’s wastewater facilities, except for the City's Municipal Airport System. All other references to the Transportation Division or the Deputy Manager of Public Works for Transportation are deleted and replaced with references to the Engineering Division and City Engineer, respectively.

**SC-4 WASTEWATER MANAGEMENT DIVISION**

The Wastewater Management Division is a unit of the Department of Public Works and is supervised by the Deputy Manager of Public Works for Wastewater Management, who is subordinate to the Manager of Public Works. This Division is responsible for the operation and maintenance of the City's wastewater facilities.

**SC-5 CITY DELEGATION OF AUTHORITY**

With reference to General Contract Condition 109, DEPUTY MANAGER and General Contract Condition 212, CITY’S CONTRACT ADMINISTRATION LINE OF AUTHORITY, the Manager hereby designates the City Engineer as the City official responsible for those certain actions and decisions designated as the responsibility of the Deputy Manager under the General Conditions and delegates to the City Engineer the authority necessary to undertake those responsibilities under this Contract. The Director shall have supervisory responsibility over the Project Manager. Additionally, Contractor questions concerning the Plans and Technical Specifications shall be directed to:

**Denver Department of Public Works / Engineering Division,**

City Project Manager

Telephone

Jim Cokeley

(303) 446-3593

**SC-6 LIQUIDATED DAMAGES**

Should the Contractor fail to complete all Work within the Contract Time allocated under the Contract Form at Paragraph 3, TERMS OF PERFORMANCE, the Contractor shall become liable to the City and County of Denver for liquidated damages, and not as a penalty, at the rate of \$500 for each day that the Contractor exceeds the time limits herein specified, all in accordance with provisions of General Contract Condition 602, LIQUIDATED DAMAGES; ADMINISTRATIVE COSTS; ACTUAL DAMAGES.

Representative hourly rates for the City administrative costs described in General Contract Condition 602.2 shall be as follows for this Project:

Project Manager	\$69 per hour
Project Engineer	\$63 per hour
Inspector	\$49 per hour
Surveying, if necessary	\$100 per hour

**SC-7 SUBCONTRACTS**

In accordance with General Contract Condition 501, SUBCONTRACTS, no limit shall apply to that percentage of the Work, which may be sublet providing that the subcontractors receive prior approval in accordance with General Contract Condition 502, SUBCONTRACTOR ACCEPTANCE.

**SC-8 RESERVED**

**SC-9 PAYMENTS TO CONTRACTORS**

The application for payment shall be submitted through Textura® Corporations Construction Management Website. Contractor recognizes and agrees that it shall be required to use the Textura Construction Payment Management System for this Project. Contractor further agrees that, to the fullest extent possible within the CPM System, the City shall be entitled to all non-Confidential records, reports, data and other information related to the project that are available to Contractor through the CPM System, including, but not limited to, information related to Contractor and subcontractor billings. To that end, Contractor agrees that it will activate any available settings within the CPM System that are necessary to grant the City access to such non-Confidential information related to the contract and the project. Applications for payment shall be based on the Contract Unit Prices or the approved Schedule of Values described in GC 903.1

In accordance with General Contract Condition 902, PAYMENT PROCEDURE, the party(ies) responsible for review of all Pay Applications shall be:

<u>Agency/Firm</u>	<u>Name</u>	<u>Telephone</u>
Public Works/Engineering Division	Paul Bountry	(303) 446-3719

In accordance with General Contract Condition 906, APPLICATIONS FOR PAYMENT, each Application submitted shall include the following:

1. The estimate of Work completed shall be based on the approved schedule of values or unit prices, as applicable, and the percent of the Work complete.
2. Each Application for Payment shall include each and every independent subcontractor's payroll information including pay dates and pay amounts.
3. The Contractor shall also submit to the Auditor and other appropriate officials of the City in a timely fashion, information required by General Contract Condition 1004, REPORTING WAGES PAID.
4. Applications for Payment must be accompanied by completed Partial or Final Claim Release Form, as appropriate, from EACH subcontractor and supplier, **AND** the Contractors' Certification of Payment Form (CCP), unless an exception is approved pursuant to General contract condition 907.

The forms, Final/Partial Release and Certificate of Payment (Subcontractor/Supplier) and the Contractor's Certification of Payment (CCP), both of which must be used are attached below. If subcontractor or supplier payments are disbursed via Textura® CPM, those systems generated Release and CCP forms are acceptable.

DEPARTMENT OF PUBLIC WORKS

FINAL/PARTIAL RELEASE AND CERTIFICATE OF PAYMENT
(SUBCONTRACTOR/SUPPLIER)

(PROJECT NO. and NAME)

Date: \_\_\_\_\_, 20\_\_.

(NAME OF CONTRACTOR)

Subcontract #: \_\_\_\_\_.

(NAME OF SUBCONTRACTOR/SUPPLIER)

Subcontract Value: \$\_\_\_\_\_.

Last Progress Payment: \$\_\_\_\_\_.

Date: \_\_\_\_\_.

Check Applicable Box:

[ ] MBE [ ] WBE

Total Paid to Date: \$\_\_\_\_\_.

Date of Last Work: \_\_\_\_\_.

The Undersigned hereby certifies that all costs, charges or expenses incurred by the undersigned or on behalf of the undersigned for any work, labor or services performed and for any materials, supplies or equipment provided on the above referenced Project or used in connection with the above referenced Subcontract (the "Work Effort") have been duly paid in full.

The Undersigned further certifies that each of the undersigned's subcontractors and suppliers that incurred or caused to be incurred, on their behalf, costs, charges or expenses in connection with the undersigned's Work Effort on the above referenced Project have been duly paid in full.

In consideration of \$\_\_\_\_\_ representing the Last Progress Payment referenced above and in further consideration of the Total Paid to Date, also referenced above, and other good and valuable consideration received and accepted by the undersigned this \_\_\_\_ day of \_\_\_\_\_, 20\_\_, the Undersigned hereby releases and discharges the City and County of Denver (the "City"), the above referenced City Project, the City's premises and property and the above referenced Contractor from all claims, liens, rights, liabilities, demands and obligations, whether known or unknown, of every nature arising out of or in connection with the performance of the work effort.

As additional consideration for the payments referenced above, the undersigned agrees to defend, indemnify and save and hold harmless the City, its officers, employees, agents and assigns and the above-referenced Contractor from and against all costs, losses, damages, causes of action, judgments under the subcontract and expenses arising out of or in connection with any claim or claims against the City or the Contractor which arise out of the Undersigned's performance of the Work Effort and which may be asserted by the Undersigned or any of its suppliers or subcontractors of any tier or any of their representatives, officers, agents, or employees.

It is acknowledged that this release is for the benefit of and may be relied upon by the City and the referenced Contractor.

The foregoing shall not relieve the undersigned of any obligation under the provisions of the Undersigned's subcontract, as the subcontract may have been amended, which by their nature survive completion of the Undersigned's work effort including, without limitation, warranties, guarantees, insurance requirements and indemnities.

STATE OF COLORADO ) ss.
CITY OF \_\_\_\_\_)

(Name of Subcontractor)

Signed and sworn before me this
day of \_\_\_\_\_, 20\_\_.

By: \_\_\_\_\_

Notary Public/Commissioner of Oaths
My Commission Expires

Title: \_\_\_\_\_







## Instructions for Completing the Contractor/Consultant Certification of Payment Form

Office of Economic Development  
Division of Small Business Opportunity  
Compliance Unit  
201 W. Colfax Ave. Dept. 907  
Denver, CO 80202  
Phone: 720-913-1999  
[DSBO@denvergov.org](mailto:DSBO@denvergov.org)

**Note:** The attached Contractor/Consultant Certification of Payment form must be completed by the Contractor/ Subconsultant and all subcontractors/subconsultant or suppliers used on the project at **any tier** and submitted with each pay application. The Contractor/Consultant is responsible for the accuracy of all information provided and is required to have each subcontractor/subconsultant or supplier fill out the appropriate forms. Please be sure to complete all information requested at the top of the form, including the name of the person who prepared this form.

If you reproduce this form, you must continue to list each of the originally listed firms, as well as any additional firms used during the performance period of the contract. Please complete an additional CCP if there is second tier-ing involved.

If you have any questions, please call the Compliance Unit of DSBO at 720.913.1999.

### Instructions for Completing the Contractor/Consultant Certification of Payment Form, per Column

**Contractor/Subcontractor or Subconsultant/Supplier Name:** In the space provided, list all subcontractors/ subconsultants and suppliers used on the project. For all M/W/S/E/DBEs use the exact name listed in the DSBO Directory.

**M/W/S/E/DBE/NON:** For each name listed, indicate whether the entity is a certified M/W/S/E/DBE.

**Column A:** Provide the contract amount, as listed at bid time, for the Contractor/Consultant and each subcontractor/subconsultant or supplier.

**Column B:** Provide the percentage portion of each listed subcontractor/subconsultant or supplier contract amount (Column A) compared to the total original contract amount in (I).

**Column C:** Provide the original contract amount (Column A) for each subcontractor/subconsultant or supplier plus any awarded alternate and/or change order amounts applicable. If an alternate/change order does not apply to the listed firm, re-enter the original contract amount (Column A).

**Column D:** Provide the percent portion of each listed subcontractor/subconsultant or supplier contract amount (Column C) compare to the current total contract amount in (II).

**Column E:** Provide the amount requested for work performed or materials supplied by each listed subcontractor/subconsultant or supplier for this pay application. The sum of the items in this column should equal the estimated amount requested for this pay application.

**Column F:** Provide the amount paid to each subcontractor/subconsultant or supplier on the previous pay application. Enter the previous pay application number in the column heading. The sum of the items listed in this column should equal the warrant amount paid to the Contractor/Consultant on the previous pay application. The amounts paid to the subcontractor/subconsultant or suppliers should be the actual amount of each check issued.

**Column G:** Provide the net paid to date for the Contractor/Subconsultant and each listed subcontractor/subconsultant or supplier.

**Column H:** Provide the percent portion of the net paid to date (Column G) for the Contractor/Subconsultant and each listed subcontractor/subconsultant or supplier of the current total contract amount in (II).

Rev: 031816

## **SC-10 CONTRACT FORMS**

In accordance with the terms and conditions of the Contract Documents, the City requires the use of certain form documents in complying with or satisfying various obligations, notifications and conditions in contracting with the City or performing Work hereunder. These form documents are referenced by title throughout the Contract Documents for mandatory use as directed. The following are the forms that shall be detached and utilized in accordance with the Contract Documents:

1. Performance and Payment Bond
2. Performance and Payment Bond Surety Authorization Letter (Sample)
3. Final/Partial Lien Release.

The following are forms that will be issued by the City during construction:

1. Notice to Apparent Low Bidder (Sample)
2. Notice to Proceed (Sample)
3. Certificate of Contract Release (Sample)

## **SC-11 CONSTRUCTION INSPECTION BY THE CITY**

General Condition 1701, CONSTRUCTION INSPECTION BY THE CITY, is modified as follows:

.1 Persons who are employees of the City or who are under contract to the City or the City as lessee will be assigned to inspect and test the Work. These persons may perform any tests and observe the Work to determine whether or not designs, materials used, manufacturing and construction processes and methods applied, and equipment installed satisfy the requirements of the drawings and specifications, accepted Shop Drawings, Product Data and Samples, and the General Contractor's warranties and guarantees. The General Contractor shall permit these inspectors unlimited access to the Work and provide means of safe access to the Work, which cost shall be included as a Cost of the Work without any increase to the Guaranteed Maximum Price. In addition, General Contractor shall provide whatever access and means of access are needed to off-site facilities used to store or manufacture materials and equipment to be incorporated into the Work and shall respond to any other reasonable request to further the inspector's ability to observe or complete any tests. Such inspections shall not relieve the General Contractor of any of its quality control responsibilities or any other obligations under the Contract. All inspections and all tests conducted by the City are for the convenience and benefit of the City. These inspections and tests do not constitute acceptance of the materials or Work tested or inspected, and the City may reject or accept any Work or materials at any time prior to the inspections pursuant to G.C. 2002, whether or not previous inspections or tests were conducted by the inspector or a City representative.

.2 Building Inspection will perform building code compliance inspections for structures designed for human occupancy. It is the General Contractor's responsibility to schedule and obtain these inspections. If a code compliance inspection results in identification of a condition which will be at variance to the Contract Documents, the General Contractor shall immediately notify the Project Manager and confirm such notification with formal correspondence no later than forty-eight (48) hours after the occurrence.

.3 When any unit of government or political subdivision, utility or Railroad Corporation is to pay a portion of the cost of the Work, its respective representatives shall have the right to inspect the Work. This inspection shall not make any unit of government or political subdivision, utility or Railroad Corporation a party to the Contract, and shall not interfere with the rights of either party.

## **SC-12 DISPOSAL OF NON-HAZARDOUS WASTE AT DADS**

In accordance with the Landfill Agreement made between the City and Waste Management of Colorado, Inc., bidders will be required to haul dedicated loads (non-hazardous entire loads of waste) to the Denver-Arapahoe Disposal Site ("DADS") for disposal. DADS is located at Highway 30 and Hampden Avenue in Arapahoe County, Colorado. The City will pay all fees associated with such disposal but the bidder shall be responsible for the costs of transporting the loads. Non-hazardous waste is defined as those substances and materials not defined or classified as hazardous by the Colorado Hazardous Waste Commission pursuant to C.R.S. §25-15-101(6), as amended from time to time, and includes construction debris, soil and asbestos. Bidders shall not use Gun Club Road between I-70 and Mississippi Avenue as a means of access to DADS.

**SC-13 PROHIBITION ON USE OF CCA-TREATED WOOD PRODUCTS**

The use of any wood products pressure-treated with chromated copper arsenate (CCA) is prohibited. Examples of CCA-treated wood products include wood used in play structures, decks, picnic tables, landscaping timbers, fencing, patios, walkways and boardwalks.

**SC-14 WAIVER OF: PART 8 OF ARTICLE 20 OF TITLE 13, COLORADO REVISED STATUTES.**

The Contractor specifically waives all the provisions of Part 8 of Article 20 of Title 13, Colorado Revised Statutes regarding defects in the Work under this Construction Contract.

**SC-15 ATTORNEY'S FEES**

Colorado Revised Statute 38-26-107 requires that in the event any person or company files a verified statement of amounts due and unpaid in connection with a claim for labor and materials supplied on this project, the City shall withhold from payments to the Contractor sufficient funds to insure the payment of any such claims. Should the City and County of Denver be made a party to any lawsuit to enforce such unpaid claims or any lawsuit arising out of or relating to such withheld funds, the Contractor agrees to pay to the City its costs and a reasonable attorney's fee which cost shall be included as a Cost of the Work.

Because the City Attorney Staff does not bill the City for legal services on an hourly basis, the Contractor agrees a reasonable fee shall be computed at the rate of one hundred dollars per hour of City Attorney time.

**SC-16 INSURANCE**

General Condition 1601 is hereby deleted in its entirety and replaced with the following:

(1) **General Conditions:** Contractor agrees to secure, at or before the time of execution of this Agreement, the following insurance covering all operations, goods or services provided pursuant to this Agreement. Contractor shall keep the required insurance coverage in force at all times during the term of the Agreement, or any extension thereof, during any warranty period, and for eight (8) years after termination of the Agreement. The required insurance shall be underwritten by an insurer licensed or authorized to do business in Colorado and rated by A.M. Best Company as "A-"VIII or better. Each policy shall contain a valid provision or endorsement requiring notification to the City in the event any of the required policies be canceled or non-renewed before the expiration date thereof. Such written notice shall be sent to the parties identified in the Notices section of this Agreement. Such notice shall reference the City contract number listed on the signature page of this Agreement. Said notice shall be sent thirty (30) days prior to such cancellation or non-renewal unless due to non-payment of premiums for which notice shall be sent ten (10) days prior. If such written notice is unavailable from the insurer, contractor shall provide written notice of cancellation, non-renewal and any reduction in coverage to the parties identified in the Notices section by certified mail, return receipt requested within three (3) business days of such notice by its insurer(s) and referencing the City's contract number. If any policy is in excess of a deductible or self-insured retention, the City must be notified by the Contractor. Contractor shall be responsible for the payment of any deductible or self-insured retention. The insurance coverages specified in this Agreement are the minimum requirements, and these requirements do not lessen or limit the liability of the Contractor. The Contractor shall maintain, at its own expense, any additional kinds or amounts of insurance that it may deem necessary to cover its obligations and liabilities under this Agreement.

(2) **Proof of Insurance:** Contractor shall provide a copy of this Agreement to its insurance agent or broker. Contractor may not commence services or work relating to the Agreement prior to placement of coverage. Contractor certifies that the certificate of insurance attached as part of the Contract Documents, preferably an ACORD certificate, complies with all insurance requirements of this Agreement. The City requests that the City's contract number be referenced on the Certificate. The City's acceptance of a certificate of insurance or other proof of insurance that does not comply with all insurance requirements set forth in this Agreement shall not act as a waiver of Contractor's breach of this Agreement or of any of the City's rights or remedies under this Agreement. The City's Risk Management Office may require additional proof of insurance, including but not limited to policies and endorsements.

(3) **Additional Insureds:** For Commercial General Liability and Auto Liability, Contractor and subcontractor's insurer(s) shall name the City and County of Denver, its elected and appointed officials, employees and volunteers as additional insured.

(4) **Waiver of Subrogation:** For all coverages, Contractor's insurer shall waive subrogation rights against the City.

(5) **Subcontractors and Subconsultants:** All subcontractors and subconsultants (including independent contractors, suppliers or other entities providing goods or services required by this Agreement) shall be subject to all of the requirements herein and shall procure and maintain the same coverages required of the Contractor. Contractor shall include all such subcontractors as additional insured under its policies (with the exception of

Workers' Compensation) or shall ensure that all such subcontractors and subconsultants maintain the required coverages. Contractor agrees to provide proof of insurance for all such subcontractors and subconsultants upon request by the City.

**(6) Workers' Compensation/Employer's Liability Insurance:** Contractor shall maintain the coverage as required by statute for each work location and shall maintain Employer's Liability insurance with limits of \$100,000 per occurrence for each bodily injury claim, \$100,000 per occurrence for each bodily injury caused by disease claim, and \$500,000 aggregate for all bodily injuries caused by disease claims. Contractor expressly represents to the City, as a material representation upon which the City is relying in entering into this Agreement, that none of the Contractor's officers or employees who may be eligible under any statute or law to reject Workers' Compensation Insurance shall effect such rejection during any part of the term of this Agreement, and that any such rejections previously effected, have been revoked as of the date Contractor executes this Agreement.

**(7) Commercial General Liability:** Contractor shall maintain a Commercial General Liability insurance policy with limits of \$1,000,000 for each occurrence, \$1,000,000 for each personal and advertising injury claim, \$2,000,000 products and completed operations aggregate, and \$2,000,000 policy aggregate.

**(8) Business Automobile Liability:** Contractor shall maintain Business Automobile Liability with limits of \$1,000,000 combined single limit applicable to all owned, hired and non-owned vehicles used in performing services under this Agreement

**(9) Additional Provisions:**

- (a) For Commercial General Liability, the policies must provide the following:
  - (i) That this Agreement is an Insured Contract under the policy;
  - (ii) Defense costs in excess of policy limits;
  - (iii) A severability of interests or separation of insureds provision (no insured vs. insured exclusion); and
  - (iv) A provision that coverage is primary and non-contributory with other coverage or self-insurance maintained by the City.
- (b) For claims-made coverage:
  - (i) The retroactive date must be on or before the contract date or the first date when any goods or services were provided to the City, whichever is earlier
- (c) Contractor shall advise the City in the event any general aggregate or other aggregate limits are reduced below the required per occurrence limits. At their own expense, and where such general aggregate or other aggregate limits have been reduced below the required per occurrence limit, the Contractor will procure such per occurrence limits and furnish a new certificate of insurance showing such coverage is in force.

**SC-17 GREENPRINT DENVER REQUIREMENTS**

In accordance with the City and County of Denver Executive Order 123: Greenprint Denver Office and Sustainability Policy, as amended, Contractor shall adhere to sections of Executive Order 123 pertinent to the construction of the built environment. This includes but is not limited to: all construction and renovation of buildings shall follow instructions and memorandum for high performance buildings; horizontal projects shall include the use of fly ash concrete and recycled aggregate where possible; and, all projects shall recycle construction and demolition waste, and install materials that contain recycled content whenever possible using the U.S. Green Building Council Leadership in Energy and Environmental Design (LEED) as guidance. Non-hazardous solid waste that is eligible for reuse or recycling is not subject to the DADS disposal requirement defined in SC-12.

A completed "Greenprint Denver Closeout Form for Construction Projects" shall be delivered to the Project Manager as a submittal requirement of Final Acceptance.

<http://www.denvergov.org/constructioncontracts/Home/ContractorResources/tabid/443154/Default.aspx>

**CITY AND COUNTY OF DENVER  
DEPARTMENT OF PUBLIC WORKS**

**PERFORMANCE AND PAYMENT BOND**

KNOW ALL MEN BY THESE PRESENTS, that we, the undersigned Insituform Technologies, LLC, 17988 Edison Avenue, Chesterfield, MO 63005, a corporation organized and existing under and by virtue of the laws of the State of Delaware, hereafter referred to as the "Contractor", and Travelers Casualty and Surety Company of America \*, a corporation organized and existing under and by virtue of the laws of the State of Connecticut and authorized to transact business in the State of Colorado, as Surety, are held and firmly bound unto the CITY AND COUNTY OF DENVER, a municipal corporation of the State of Colorado, hereinafter referred to as the "City", in the penal sum of Two Million One Hundred Ninety Five Thousand Seven Hundred Sixty Nine Dollars & 50/100's Dollars (\$ 2,195,769.50), lawful money of the United States of America, for the payment of which sum, well and truly to be made, we bind ourselves and our heirs, executors, administrators, successors and assigns, jointly and severally, firmly by these presents;

THE CONDITION OF THE FOREGOING OBLIGATION IS SUCH THAT: \* One Tower Square  
Hartford, CT 06183

WHEREAS, the above bounden Contractor has entered into a written contract with the aforesaid City for furnishing all labor and tools, supplies, equipment, superintendence, materials and everything necessary for and required to do, perform and complete the construction of **CONTRACT NO. 201843656 GENERAL SANITARY - CHERRY CREEK IMPROVEMENTS**, Denver, Colorado, and has bound itself to complete the project within the time or times specified or pay liquidated damages, all as designated, defined and described in the said Contract and Conditions thereof, and in accordance with the Plans and Technical Specifications therefore, a copy of said Contract being made a part hereof;

NOW, THEREFORE, if the said Contractor shall and will, in all particulars well and truly and faithfully observe, perform and abide by each and every Covenant, Condition and part of said Contract, and the Conditions, Technical Specifications, Plans, and other Contract Documents thereto attached, or by reference made a part thereof and any alterations in and additions thereto, according to the true intent and meaning in such case, then this obligation shall be and become null and void; otherwise, it shall remain in full force and effect;

PROVIDED FURTHER, that if the said Contractor shall satisfy all claims and demands incurred by the Contractor in the performance of said Contract, and shall fully indemnify and save harmless the City from all damages, claims, demands, expense and charge of every kind (including claims of patent infringement) arising from any act, omission, or neglect of said Contractor, its agents, or employees with relation to said work; and shall fully reimburse and repay to the City all costs, damages, and expenses which it may incur in making good any default based upon the failure of the Contractor to fulfill its obligation to furnish maintenance, repairs or replacements for the full guarantee period provided in the Contract Documents, then this obligation shall be null and void; otherwise it shall remain in full force and effect;

PROVIDED FURTHER, that if said Contractor shall at all times promptly make payments of all amounts lawfully due to all persons supplying or furnishing it or its subcontractors with labor and materials, rental machinery, tools or equipment used or performed in the prosecution of work provided for in the above Contract and that if the Contractor will indemnify and save harmless the City for the extent of any and all payments in connection with the carrying out of such Contract, then this obligation shall be null and void; otherwise it shall remain in full force and effect;

PROVIDED FURTHER, that if the said Contractor fails to duly pay for any labor, materials, team hire, sustenance, provisions, provender, gasoline, lubricating oils, fuel oils, grease, coal, or any other supplies or materials used or consumed by said Contractor or its subcontractors in performance of the work contracted to be done, or fails to pay any person who supplies rental machinery, tools or equipment, all amounts due as the result of the use of such machinery, tools or equipment in the prosecution of the work, the Surety will pay the same in any amount not exceeding the amount of this obligation, together with interest as provided by law;

PROVIDED FURTHER, that the said Surety, for value received, hereby stipulates and agrees that no change, extension of time, alteration or addition to the terms of the Contract, or to contracts with others in connection with this project, or the work to be performed thereunder, or the Technical Specifications and Plans accompanying the same, shall in any way affect its obligation on this bond and it does hereby waive notice of any change, extension of time, alteration or addition to the terms of the Contract, or contracts, or to the work, or to the Technical Specifications and Plans.

IN WITNESS WHEREOF, said Contractor and said Surety have executed these presents as of this

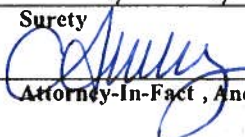

21st day of September, 2018.

Attest:   
Secretary  
**Laura M. Andreski**  
Contracting & Attesting Officer

**Insituform Technologies, LLC**  
Contractor  
By:   
President Whitney Schulte,  
Contracting & Attesting Officer  
**Travelers Casualty and Surety Company of America**  
Surety  
By:   
Attorney-In-Fact, Andrea McCarthy

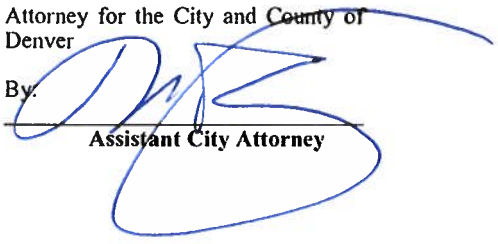
(Accompany this bond with Attorney-in-Fact's authority from the Surety to execute bond, certified to include the date of the bond).

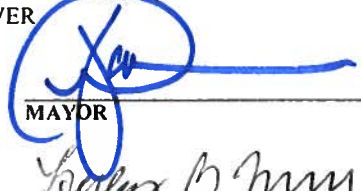
APPROVED AS TO FORM:  
Attorney for the City and County of  
Denver  
By:   
Assistant City Attorney

APPROVED FOR THE CITY AND COUNTY OF  
DENVER  
By:   
MAYOR  
By:   
EXECUTIVE DIRECTOR OF PUBLIC WORKS  
9

State of Missouri  
County of St. Louis

On 9/12/2018, before me, a Notary Public in and for said County and State, residing therein, duly commissioned and sworn, personally appeared Andrea McCarthy known to me to be Attorney-in-Fact of

## TRAVELERS CASUALTY AND SURETY COMPANY OF AMERICA

the corporation described in and that executed the within and foregoing instrument, and known to me to be the person who executed the said instrument in behalf of said corporation, and he duly acknowledged to me that such corporation executed the same.

IN WITNESS WHEREOF, I have hereunto set my hand and affixed my official seal, the day and year stated in this certificate above.



\_\_\_\_\_  
Ashley Miller, Notary Public



My Commission Expires: \_\_\_\_\_



**Travelers Casualty and Surety Company of America  
Travelers Casualty and Surety Company  
St. Paul Fire and Marine Insurance Company**

**POWER OF ATTORNEY**

**KNOW ALL MEN BY THESE PRESENTS:** That Travelers Casualty and Surety Company of America, Travelers Casualty and Surety Company, and St. Paul Fire and Marine Insurance Company are corporations duly organized under the laws of the State of Connecticut (herein collectively called the "Companies"), and that the Companies do hereby make, constitute and appoint **Andrea McCarthy**, of Chesterfield, Missouri, their true and lawful Attorney-in-Fact to sign, execute, seal and acknowledge any and all bonds, recognizances, conditional undertakings and other writings obligatory in the nature thereof on behalf of the Companies in their business of guaranteeing the fidelity of persons, guaranteeing the performance of contracts and executing or guaranteeing bonds and undertakings required or permitted in any actions or proceedings allowed by law.

**IN WITNESS WHEREOF**, the Companies have caused this instrument to be signed, and their corporate seals to be hereto affixed, this 3rd day of February, 2017.



State of Connecticut

City of Hartford ss.

By:   
Robert L. Raney, Senior Vice President

On this the 3rd day of February, 2017, before me personally appeared Robert L. Raney, who acknowledged himself to be the Senior Vice President of Travelers Casualty and Surety Company of America, Travelers Casualty and Surety Company, and St. Paul Fire and Marine Insurance Company, and that he, as such, being authorized so to do, executed the foregoing instrument for the purposes therein contained by signing on behalf of the corporations by himself as a duly authorized officer.

In Witness Whereof, I hereunto set my hand and official seal.

My Commission expires the 30th day of June, 2021



  
Marie C. Tetreault, Notary Public

This Power of Attorney is granted under and by the authority of the following resolutions adopted by the Boards of Directors of Travelers Casualty and Surety Company of America, Travelers Casualty and Surety Company, and St. Paul Fire and Marine Insurance Company, which resolutions are now in full force and effect, reading as follows:

**RESOLVED**, that the Chairman, the President, any Vice Chairman, any Executive Vice President, any Senior Vice President, any Vice President, any Second Vice President, the Treasurer, any Assistant Treasurer, the Corporate Secretary or any Assistant Secretary may appoint Attorneys-in-Fact and Agents to act for and on behalf of the Company and may give such appointee such authority as his or her certificate of authority may prescribe to sign with the Company's name and seal with the Company's seal bonds, recognizances, contracts of indemnity, and other writings obligatory in the nature of a bond, recognizance, or conditional undertaking, and any of said officers or the Board of Directors at any time may remove any such appointee and revoke the power given him or her; and it is

**FURTHER RESOLVED**, that the Chairman, the President, any Vice Chairman, any Executive Vice President, any Senior Vice President or any Vice President may delegate all or any part of the foregoing authority to one or more officers or employees of this Company, provided that each such delegation is in writing and a copy thereof is filed in the office of the Secretary; and it is

**FURTHER RESOLVED**, that any bond, recognizance, contract of indemnity, or writing obligatory in the nature of a bond, recognizance, or conditional undertaking shall be valid and binding upon the Company when (a) signed by the President, any Vice Chairman, any Executive Vice President, any Senior Vice President or any Vice President, any Second Vice President, the Treasurer, any Assistant Treasurer, the Corporate Secretary or any Assistant Secretary and duly attested and sealed with the Company's seal by a Secretary or Assistant Secretary; or (b) duly executed (under seal, if required) by one or more Attorneys-in-Fact and Agents pursuant to the power prescribed in his or her certificate or their certificates of authority or by one or more Company officers pursuant to a written delegation of authority; and it is

**FURTHER RESOLVED**, that the signature of each of the following officers: President, any Executive Vice President, any Senior Vice President, any Vice President, any Assistant Vice President, any Secretary, any Assistant Secretary, and the seal of the Company may be affixed by facsimile to any Power of Attorney or to any certificate relating thereto appointing Resident Vice Presidents, Resident Assistant Secretaries or Attorneys-in-Fact for purposes only of executing and attesting bonds and undertakings and other writings obligatory in the nature thereof, and any such Power of Attorney or certificate bearing such facsimile signature or facsimile seal shall be valid and binding upon the Company and any such power so executed and certified by such facsimile signature and facsimile seal shall be valid and binding on the Company in the future with respect to any bond or understanding to which it is attached.

I, **Kevin E. Hughes**, the undersigned, Assistant Secretary of Travelers Casualty and Surety Company of America, Travelers Casualty and Surety Company, and St. Paul Fire and Marine Insurance Company, do hereby certify that the above and foregoing is a true and correct copy of the Power of Attorney executed by said Companies, which remains in full force and effect.

Dated this 12 day of September, 2018



  
Kevin E. Hughes, Assistant Secretary

**To verify the authenticity of this Power of Attorney, please call us at 1-800-421-3880.  
Please refer to the above-named Attorney-in-Fact and the details of the bond to which the power is attached.**



# J.W.TERRILL

a Marsh & McLennan Agency LLC company

## Insurance, Benefits & Risk Management

Suite 200  
825 Maryville Centre Drive  
St. Louis, MO 63017

314-594-2700

[www.jwterrill.com](http://www.jwterrill.com)

September 12, 2018

Assistant City Attorney  
City and County of Denver  
Department of Public Works  
201 W. Colfax Avenue, Dept. 1207  
Denver, CO 80202

**Re: Insituform Technologies, LLC**  
**Bond No. 106962718**  
**Project: Contract 201843656, General Sanitary- Cherry Creek Improvements**  
**Contract Amount: \$2,195,769.50**

To Whom It May Concern:

The Performance & Payment bond covering the above captioned project were executed by this agency through Travelers Casualty and Surety Company of America insurance company on September 12, 2018.

We hereby authorize City and County of Denver, Department of Public Works to date the Performance & Payment bond, power of attorney and Jurat.

If you should have any questions or concerns, please call me at (314) 594-2700.

Sincerely,  
J. W. Terrill, a Marsh & McLennan Agency, LLC company

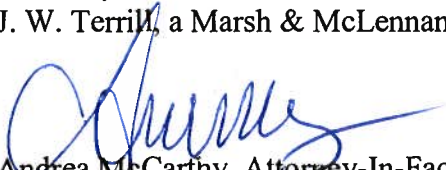

Andrea McCarthy, Attorney-In-Fact  
Travelers Casualty and Surety Company of America



# CERTIFICATE OF LIABILITY INSURANCE

7/1/2019

DATE (MM/DD/YYYY)

9/12/2018

THIS CERTIFICATE IS ISSUED AS A MATTER OF INFORMATION ONLY AND CONFERS NO RIGHTS UPON THE CERTIFICATE HOLDER. THIS CERTIFICATE DOES NOT AFFIRMATIVELY OR NEGATIVELY AMEND, EXTEND OR ALTER THE COVERAGE AFFORDED BY THE POLICIES BELOW. THIS CERTIFICATE OF INSURANCE DOES NOT CONSTITUTE A CONTRACT BETWEEN THE ISSUING INSURER(S), AUTHORIZED REPRESENTATIVE OR PRODUCER, AND THE CERTIFICATE HOLDER.

**IMPORTANT:** If the certificate holder is an ADDITIONAL INSURED, the policy(ies) must have ADDITIONAL INSURED provisions or be endorsed. If SUBROGATION IS WAIVED, subject to the terms and conditions of the policy, certain policies may require an endorsement. A statement on this certificate does not confer rights to the certificate holder in lieu of such endorsement(s).

<b>PRODUCER</b> Lockton Companies Three City Place Drive, Suite 900 St. Louis MO 63141-7081 (314) 432-0500	<b>CONTACT NAME:</b> _____ <b>PHONE (A/C, No, Ext):</b> _____ <b>FAX (A/C, No):</b> _____ <b>E-MAIL ADDRESS:</b> _____	
	<b>INSURER(S) AFFORDING COVERAGE</b>	
<b>INSURED</b> 1347989 Insituform Technologies, LLC 17988 Edison Avenue Chesterfield MO 63005	<b>INSURER A:</b> XL Insurance America, Inc.	<b>NAIC #</b> 24554
	<b>INSURER B:</b> ACE American Insurance Company	22667
	<b>INSURER c:</b> Indemnity Insurance Co of North America	43575
	<b>INSURER D:</b>	
	<b>INSURER E:</b>	
<b>INSURER F:</b>		

**COVERAGES** INSTE02 **CERTIFICATE NUMBER:** 15604267 **REVISION NUMBER:** XXXXXXXX

THIS IS TO CERTIFY THAT THE POLICIES OF INSURANCE LISTED BELOW HAVE BEEN ISSUED TO THE INSURED NAMED ABOVE FOR THE POLICY PERIOD INDICATED. NOTWITHSTANDING ANY REQUIREMENT, TERM OR CONDITION OF ANY CONTRACT OR OTHER DOCUMENT WITH RESPECT TO WHICH THIS CERTIFICATE MAY BE ISSUED OR MAY PERTAIN, THE INSURANCE AFFORDED BY THE POLICIES DESCRIBED HEREIN IS SUBJECT TO ALL THE TERMS, EXCLUSIONS AND CONDITIONS OF SUCH POLICIES. LIMITS SHOWN MAY HAVE BEEN REDUCED BY PAID CLAIMS.

INSR LTR	TYPE OF INSURANCE	ADDL INSD	SUBR WVD	POLICY NUMBER	POLICY EFF (MM/DD/YYYY)	POLICY EXP (MM/DD/YYYY)	LIMITS
A	<input checked="" type="checkbox"/> COMMERCIAL GENERAL LIABILITY <input type="checkbox"/> CLAIMS-MADE <input checked="" type="checkbox"/> OCCUR <input checked="" type="checkbox"/> Independt Contractor <input checked="" type="checkbox"/> XCU GEN'L AGGREGATE LIMIT APPLIES PER: <input type="checkbox"/> POLICY <input checked="" type="checkbox"/> PROJECT <input checked="" type="checkbox"/> LOC OTHER: _____	Y	Y	CGD300084903  BROAD FORM PD/CONTRACTUAL	7/1/2018	7/1/2019	EACH OCCURRENCE \$ 2,000,000 DAMAGE TO RENTED PREMISES (Ea occurrence) \$ 1,000,000 MED EXP (Any one person) \$ 10,000 PERSONAL & ADV INJURY \$ 2,000,000 GENERAL AGGREGATE \$ 4,000,000 PRODUCTS - COMP/OP AGG \$ 4,000,000
B	<input checked="" type="checkbox"/> AUTOMOBILE LIABILITY <input checked="" type="checkbox"/> ANY AUTO <input type="checkbox"/> OWNED AUTOS ONLY <input type="checkbox"/> SCHEDULED AUTOS <input type="checkbox"/> HIRED AUTOS ONLY <input type="checkbox"/> NON-OWNED AUTOS ONLY <input type="checkbox"/> AUTOS ONLY	Y	Y	ISA H25158945	7/1/2018	7/1/2019	COMBINED SINGLE LIMIT (Ea accident) \$ 5,000,000 BODILY INJURY (Per person) \$ XXXXXXXX BODILY INJURY (Per accident) \$ XXXXXXXX PROPERTY DAMAGE (Per accident) \$ XXXXXXXX \$ XXXXXXXX EACH OCCURRENCE \$ XXXXXXXX AGGREGATE \$ XXXXXXXX \$ XXXXXXXX
	<input type="checkbox"/> UMBRELLA LIAB <input type="checkbox"/> OCCUR <input type="checkbox"/> EXCESS LIAB <input type="checkbox"/> CLAIMS-MADE DED _____ RETENTION \$ _____			NOT APPLICABLE			EACH OCCURRENCE \$ XXXXXXXX AGGREGATE \$ XXXXXXXX \$ XXXXXXXX
B C	<input checked="" type="checkbox"/> WORKERS COMPENSATION AND EMPLOYERS' LIABILITY ANY PROPRIETOR/PARTNER/EXECUTIVE OFFICER/MEMBER EXCLUDED? (Mandatory in NH) If yes, describe under DESCRIPTION OF OPERATIONS below	Y/N N	N/A	WLRC65224987 (CA/MA) WLRC6522494A (AOS)	7/1/2018 7/1/2018	7/1/2019 7/1/2019	<input checked="" type="checkbox"/> PER STATUTE <input type="checkbox"/> OTH-ER E.L. EACH ACCIDENT \$ 1,000,000 E.L. DISEASE - EA EMPLOYEE \$ 1,000,000 E.L. DISEASE - POLICY LIMIT \$ 1,000,000

DESCRIPTION OF OPERATIONS / LOCATIONS / VEHICLES (ACORD 101, Additional Remarks Schedule, may be attached if more space is required)  
 PROJECT: INSITUFORM JOB NO. 170955; CONTRACT NO. 201843656 GENERAL SANITARY - CHERRY CREEK IMPROVEMENTS. CITY AND COUNTY OF DENVER, ITS ELECTED AND APPOINTED OFFICIALS, EMPLOYEES AND VOLUNTEERS ARE ADDITIONAL INSURED ON A PRIMARY AND NON-CONTRIBUTORY BASIS UNDER GENERAL LIABILITY AND AUTOMOBILE LIABILITY AS REQUIRED BY WRITTEN CONTRACT. WAIVER OF SUBROGATION APPLIES UNDER GENERAL LIABILITY, AUTOMOBILE LIABILITY, AND WORKERS' COMPENSATION WHERE PERMISSIBLE BY LAW AS REQUIRED BY WRITTEN CONTRACT.

**CERTIFICATE HOLDER**

15604267  
 CITY AND COUNTY OF DENVER  
 201 COLFAX AVENUE  
 DENVER CO 80202

**CANCELLATION** See Attachments

SHOULD ANY OF THE ABOVE DESCRIBED POLICIES BE CANCELLED BEFORE THE EXPIRATION DATE THEREOF, NOTICE WILL BE DELIVERED IN ACCORDANCE WITH THE POLICY PROVISIONS.

AUTHORIZED REPRESENTATIVE



**PERFORMANCE AND PAYMENT BOND  
SURETY AUTHORIZATION  
(SAMPLE)**

FAX NUMBER: 720-913-3183  
TELEPHONE NUMBER: 720-913-3267

Assistant City Attorney  
201 W. Colfax Ave. Dept 1207  
Denver, Colorado 80202

RE: (Company name)

Contract No: 201843656  
Project Name: GENERAL SANITARY - CHERRY CREEK IMPROVEMENTS  
Contract Amount:  
Performance and Payment Bond No.:

Dear Assistant City Attorney,

The Performance and Payment Bonds covering the above captioned project were executed by this agency, through \_\_\_\_\_ insurance company, on \_\_\_\_\_, 20\_\_.

We hereby authorize the City and County of Denver, Department of Public Works, to date all bonds and powers of attorney to coincide with the date of the contract.

If you should have any additional questions or concerns, please don't hesitate to give me a call at \_\_\_\_\_.

Thank you.

Sincerely,

Denver Public Works/Office of the Executive Director  
201 West Colfax Avenue, Dept 608 | Denver, CO 80202  
[www.denvergov.org/dpw](http://www.denvergov.org/dpw)  
p. 720.865.8630 | f. 720.865.8795

**311 | POCKETGOV.COM | DENVERGOV.ORG | DENVER 8 TV**



**NOTICE OF APPARENT LOW BIDDER**  
**(SAMPLE)**

Current Date

To:     TBD  
          TBD  
          TBD

Gentlemen:

The EXECUTIVE DIRECTOR OF PUBLIC WORKS has considered the Bids submitted on August 30, 2018 for work to be done and materials to be furnished in and for:

**PROJECT No. 201843656 GENERAL SANITARY - CHERRY CREEK IMPROVEMENTS**

as set forth in detail in the Contract Documents for the City and County of Denver, Colorado. It appears that your Bid is fair, equitable, and to the best interest of the City and County; therefore, said Bid is hereby accepted at the bid price contained herein, subject to execution of the Contract Documents and your furnishing the items specified below, the total cost thereof (Contract Amount Written), (Contract Amount Numeric).

It will be necessary for you to appear forthwith at the office of the Department of Public Works, Finance and Administration, 201 W. Colfax Ave. Dept 614, Denver, Colorado 80202, to receive the said Contract Documents, execute the same and return them to the Department of Public Works, Finance and Administration, within the time limit set forth in the Bid Proposal.

In accordance with the requirements set forth in the Contract Documents, you are required to furnish the following documents:

- a.     Insurance Certificates: General Liability and Automotive Liability, Workman's Compensation and Employer Liability; or any other coverage required by the contract; and
- b.     One original plus four copies of the Power of Attorney relative to Performance and/or Payment Bond;

All construction Contracts made and entered into by the City and County of Denver are subject to Affirmative Action and Equal Opportunity Rules and Regulations, as adopted by the Manager of Public Works, and each contract requiring payment by the City of one-half million dollars (\$500,000.00) or more shall first be approved by the City Council acting by ordinance and in accordance with Section 3.2.6 of the Charter of the City and County of Denver.

Prior to issuance of Notice to Proceed, all Equal Opportunity requirements must be completed. Additional information may be obtained by contacting the Director of Contract Compliance at (720-913-1700).

**NOTICE OF APPARENT LOW BIDDER  
(SAMPLE)**

PROJECT NO. 201843656

Page 2

The Bid Security submitted with your Bid, will be returned upon execution of the Contract and furnishing of the Performance Bond. In the event you should fail to execute the Contract and to furnish the performance Bond within the time limit specified, said Bid Security will be retained by the City and County of Denver as liquidated damages, and not as a penalty for the delay and extra work caused thereby.

Dated at Denver, Colorado this \_\_\_\_\_ day of \_\_\_\_\_ 20\_\_\_\_.

CITY AND COUNTY OF DENVER

By \_\_\_\_\_  
Executive Director of Public Works

Denver Public Works/Office of the Executive Director  
201 West Colfax Avenue, Dept 608 | Denver, CO 80202  
[www.denvergov.org/dpw](http://www.denvergov.org/dpw)  
p. 720.865.8630 | f. 720.865.8795

**311 | POCKETGOV.COM | DENVERGOV.ORG | DENVER 8 TV**



Current Date

**NOTICE TO PROCEED  
(SAMPLE)**

Name  
Company  
Street  
City/State/Zip

**CONTRACT NO. 201843656, GENERAL SANITARY - CHERRY CREEK IMPROVEMENTS**

In accordance with General Contract Condition 302 of the Standard Specifications for Construction, General Contract Conditions, 2011 Edition, you are hereby authorized and directed to proceed on \_\_\_\_\_ with the work of constructing contract number 201843656, as set forth in detail in the contract documents for the City and County of Denver.

With a contract time of \_\_\_\_\_ calendar days, the project must be complete on or before \_\_\_\_\_.

If you have not already done so, you must submit your construction schedule, in accordance with General Contract Condition 306.2.B, to the Project Manager within 10 days. Additionally, you must submit your tax exempt certificate, and copies of your subcontractors' certificates, in accordance with General Contract Condition 323.5, to the Project Manager as soon as possible. Failure to submit these certificates will delay processing of payment applications.

Sincerely,

Lesley B. Thomas  
City Engineer

cc:

Denver Public Works/Office of the Executive Director  
201 West Colfax Avenue, Dept 608 | Denver, CO 80202  
[www.denvergov.org/dpw](http://www.denvergov.org/dpw)  
p. 720.865.8630 | f. 720.865.8795

**311 | POCKETGOV.COM | DENVERGOV.ORG | DENVER 8 TV**



Certificate of Contract Release  
(SAMPLE)

Date

Name

Company

Street

City/State/Zip

RE: Certificate of Contract Release for  
**201843656, GENERAL SANITARY - CHERRY CREEK IMPROVEMENTS**

Received this date of the City and County of Denver, as full and final payment of the cost of the improvements provided for in the foregoing contract, \_\_\_\_\_ dollars and \_\_\_\_\_ cents (\$\_\_\_\_\_), in cash, being the remainder of the full amount accruing to the undersigned by virtue of said contract; said cash also covering and including full payment for the cost of all extra work and material furnished by the undersigned in the construction of said improvements, and all incidentals thereto, and the undersigned hereby releases said City and County of Denver from any and all claims or demands whatsoever, regardless of how denominated, growing out of said contract.

And these presents are to certify that all persons performing work upon or furnishing materials for said improvements under the foregoing contract have been paid in full and this payment to be made is the last or final payment.

\_\_\_\_\_  
Contractor's Signature

\_\_\_\_\_  
Date Signed

If there are any questions, please contact me by telephone at (720) 913-XXXX. Please return this document via facsimile at (720) 913-1805 and mail to original to the above address.

Denver Public Works/Office of the Executive Director  
201 West Colfax Avenue, Dept 608 | Denver, CO 80202  
[www.denvergov.org/dpw](http://www.denvergov.org/dpw)  
p. 720.865.8630 | f. 720.865.8795

**311 | POCKETGOV.COM | DENVERGOV.ORG | DENVER 8 TV**

CITY AND COUNTY OF DENVER

STATE OF COLORADO



**DENVER**  
THE MILE HIGH CITY

DEPARTMENT OF PUBLIC WORKS

Addenda

Contract Number: 201843656



General Sanitary – Cherry Creek Improvements

August 1, 2018



**CITY AND COUNTY OF DENVER  
DEPARTMENT OF PUBLIC WORKS**

<b>CONTRACT NO: 201843656</b> <b>PROJECT NAME: General Sanitary – Cherry Creek East Improvements</b>
---

**ADDENDUM NO. 1 TO CONTRACT DOCUMENTS**

Bidders are hereby instructed that the drawings, specifications, and other contract documents are modified, corrected, supplemented and/or superseded for the above-mentioned project as hereinafter described in the following attachments:

This **ADDENDUM** shall be attached to, become a part of, and be returned with the Bid Proposal.

**QUESTIONS AND ANSWERS:**

- Q1.** Map Page 14: Please verify 439LF of 21" at Bayaud & Steele – MH23002 and MH22996? It looks more like 62LF in the parking ramp for Cherry Creek mall on google earth.
- A1.** *Pipe information is taken from the City's GIS data, which is a combination of as-built, design, and field data entry. We are aware that errors exist in this data set, but labeling utilizes the GIS data for consistency purposes. The physical length is 62 LF in GIS, but the plan set and cost estimate reflect 439 LF. Pay will be based on the field measurement. A table of GIS labels and associated main's physical length in GIS (CCE\_SAN\_IMPROVEMENTS-LABEL\_VS\_GIS\_LENGTH.PDF) are provided for your information.*
- Q2.** Map page #14: 1st & Steele intersection; could CCD provide a better satellite map location for MH22336 & MH43522?
- A2.** *A sketch of the aerial (Cherry Creek East Sanitary Lining – Steele Street Aerial.PDF) was provided at the Pre-bid and is appended to this Addendum.*
- Q3.** Are Cable Curing Temperature Sensors (i.e. thermal tape) required for the project?
- A3.** *Thermal Tape is required for mains that are 12" diameter and larger (4,038 LF based on the project's Summary of Quantities). Include this cost in cost for the CIPP Liner.*
- Q4.** Is UV-cured lining per ASTM F2019 allowed?
- A4.** *UV-cured lining is allowed for this project. A revised Specification for Section 10.7 is provided (SCS\_10\_07\_w\_UV.doc.pdf). Revisions and additional language from the Bid Set's Specifications are highlighted in yellow.*
- Q5.** Are hydrophilic seals required?
- A5.** *Hydrophilic seals are required at both ends of all lined mains at the manhole. Include this cost in cost for the CIPP Liner.*

**SPECIAL INSTRUCTIONS FOR BID:**

1 - The cost estimate includes an allowance account for Uniform Traffic Control for \$6,000, which is to be used for security purposes. 2 - Grinding is to be paid based on the lineal feet of physical grinding performed on the main, as measured in the field (not length of pipe or length up to and including grinding efforts). 3 - Coordinate with hotels and in-progress construction/developments to determine the best time to perform lining that minimizes impacts to their daily operations. Night and weekend work, as well as bypass pumping from the cleanout, may be necessary. 4 - Include by-pass pumping in the bid. Claims, as a result of not bypassing, are borne by the contractor.

*Lesley B Thomas*

Lesley B. Thomas  
City Engineer

*8.20.18*

Date

The undersigned bidder acknowledges receipt of this Addendum. The Proposal submitted herewith is in accordance with the stipulations set forth herein.

\_\_\_\_\_  
Contractor

ADDENDUM NO.   1  

\_\_\_\_\_  
Date

## CHERRY CREEK EAST SANITARY IMPROVEMENTS - PIPE LABEL VS. GIS LENGTH

FACILITYID	PIPEINFO	SHAPE LENGTH
20047SAGM	215' - 8" - VCP - 0.4%	217.1
20065SAGM	159.2' - 8" - VCP - 2.38%	159.0
20066SAGM	330' - 8" - VCP - 2.8%	329.9
20067SAGM	300' - 8" - VCP - 0.8%	300.3
20068SAGM	300' - 8" - VCP - 3.4%	299.3
20069SAGM	325.14' - 8" - VCP - 2%	325.8
20070SAGM	325' - 8" - VCP - 1.24%	325.0
20097SAGM	325' - 8" - VCP - 3.2%	323.9
20103SAGM	321.95' - 8" - VCP - 2.2%	323.4
20110SAGM	259.88' - 8" - VCP - 0.4%	258.4
20114SAGM	262.66' - 8" - VCP - 1%	263.0
20120SAGM	162.8' - 8" - VCP - 0.44%	161.8
20121SAGM	202.5' - 8" - VCP - 0.4%	202.9
20122SAGM	166.4' - 8" - VCP - 0.3%	165.4
20126SAGM	134' - 8" - VCP - 0.4%	134.1
20138SAGM	161.92' - 8" - VCP - 0.8%	158.8
20139SAGM	262.34' - 8" - VCP - 0.4%	257.4
20140SAGM	330' - 8" - VCP - 0.8%	328.2
20145SAGM	260' - 8" - VCP - 1%	260.9
20163SAGM	285.2' - 8" - VCP - 0.4%	284.8
20166SAGM	39.6' - 8" - VCP - 2.24%	45.3
20167SAGM	125' - 8" - VCP - 2.55%	125.7
20171SAGM	275' - 8" - VCP - 2.2%	274.6
20174SAGM	250' - 8" - VCP - 3.25%	249.4
20175SAGM	293' - 8" - VCP - 2.65%	292.7
20180SAGM	279.8' - 8" - VCP - 3.1%	280.4
20182SAGM	289.6' - 8" - VCP - 2.4%	286.5
20184SAGM	69' - 8" - VCP - 3.12%	65.1
20190SAGM	39.6' - 8" - RCP - 2.24%	45.5
20191SAGM	240' - 8" - VCP - 2.24%	244.0
20192SAGM	280' - 8" - VCP - 3.1%	280.6
20193SAGM	290' - 8" - VCP - 2.6%	293.3
20196SAGM	40' - 8" - VCP - 0.63%	39.0
20197SAGM	78' - 8" - VCP - 0.41%	76.9
20198SAGM	77.5' - 8" - VCP - 0.4%	70.7
20199SAGM	77.85' - 8" - VCP - 0.4%	77.2
20201SAGM	62.2' - 8" - VCP - 0.4%	62.5
20202SAGM	210.25' - 8" - VCP - 4.71%	204.5
20204SAGM	310' - 8" - VCP - 2.3%	311.8
20205SAGM	380' - 8" - VCP - 4.05%	381.2
20206SAGM	380' - 8" - VCP - 3.7%	379.1
20208SAGM	290' - 8" - VCP - 2.4%	281.5
20210SAGM	205' - 8" - VCP - 4.79%	208.3
20216SAGM	246.61' - 8" - VCP - 0.8%	246.6

## CHERRY CREEK EAST SANITARY IMPROVEMENTS - PIPE LABEL VS. GIS LENGTH

FACILITYID	PIPEINFO	SHAPE LENGTH
20220SAGM	155.5' - 8" - VCP - 0.4%	153.4
20221SAGM	174.5' - 8" - VCP - 0.4%	179.3
20226SAGM	305' - 8" - VCP - 2.48%	303.5
20230SAGM	313' - 8" - VCP - 0.4%	310.2
20231SAGM	313' - 8" - VCP - 0.4%	313.4
20232SAGM	330.6' - 8" - VCP - 0.4%	331.1
20233SAGM	313' - 8" - VCP - 2.55%	313.3
20234SAGM	313' - 8" - VCP - 2.75%	313.2
20235SAGM	312.8' - 8" - VCP - 2.6%	312.5
20238SAGM	185.86' - 8" - VCP - 2.16%	185.4
20239SAGM	182.6' - 8" - VCP - 1.98%	182.6
20241SAGM	155' - 8" - VCP - 0.4%	157.7
20242SAGM	310' - 8" - VCP - 0.5%	306.8
20275SAGM	265' - 8" - VCP - 2.4%	267.7
20281SAGM	265' - 8" - VCP - 2.4%	267.4
20289SAGM	264.7' - 8" - VCP - 2%	260.8
20323SAGM	298' - 8" - VCP - 3.5%	296.8
21616SAGM	14' - 8" - VCP - 0.14%	14.1
21617SAGM	132.2' - 8" - VCP - 0.6%	133.6
21618SAGM	51.9' - 8" - VCP - 4.51%	48.5
21619SAGM	339.88' - 8" - VCP - 4.5%	338.8
21620SAGM	321' - 8" - VCP - 6.83%	324.4
21621SAGM	300' - 8" - VCP - 2%	301.4
21622SAGM	325' - 8" - VCP - 4.2%	324.2
21623SAGM	300' - 8" - VCP - 0.4%	298.1
21624SAGM	325' - 8" - VCP - 0.4%	324.7
21625SAGM	315' - 8" - VCP - 0.4%	311.7
21626SAGM	323' - 8" - VCP - 0.4%	325.2
21627SAGM	347.87' - 8" - VCP - 0.4%	349.8
21628SAGM	310' - 8" - VCP - 0.4%	306.9
21629SAGM	180' - 8" - VCP - 0.4%	177.6
21630SAGM	225' - 8" - VCP - 5.52%	223.7
21631SAGM	220.92' - 8" - VCP - 5.51%	221.3
21632SAGM	280' - 8" - VCP - 0.8%	279.4
21633SAGM	300' - 8" - VCP - 2%	301.2
21634SAGM	300' - 8" - VCP - 0.4%	300.2
21635SAGM	315' - 8" - VCP - 0.4%	315.0
21636SAGM	335.5' - 8" - VCP - 3.4%	337.5
21637SAGM	280' - 8" - VCP - 1.6%	280.3
21638SAGM	301' - 8" - VCP - 0.4%	302.0
21639SAGM	325.17' - 8" - VCP - 0.8%	325.1
21640SAGM	315' - 8" - VCP - 3.82%	317.9
21641SAGM	19.58' - 8" - VCP - 7%	19.9
21642SAGM	210' - 8" - VCP - 5.2%	210.3

## CHERRY CREEK EAST SANITARY IMPROVEMENTS - PIPE LABEL VS. GIS LENGTH

FACILITYID	PIPEINFO	SHAPE LENGTH
21643SAGM	255.91' - 8" - VCP - 1.63%	254.9
21644SAGM	192.27' - 8" - VCP - 5.2%	192.3
21645SAGM	147.5' - 8" - VCP - 3.28%	152.0
21646SAGM	166.5' - 8" - VCP - 2.61%	165.9
21650SAGM	134.09' - 8" - VCP - 1.63%	134.1
21651SAGM	121' - 8" - VCP - 1.28%	121.3
21652SAGM	291' - 8" - VCP - 3%	290.7
21653SAGM	325' - 8" - VCP - 1.16%	325.2
21655SAGM	305.5' - 8" - VCP - 0.4%	306.3
21656SAGM	127.19' - 8" - VCP - 1.63%	127.2
21657SAGM	58.58' - 8" - VCP - 0.4%	58.6
21658SAGM	188.5' - 8" - VCP - 5.68%	187.5
21660SAGM	250' - 8" - VCP - 0.42%	249.8
21662SAGM	338.18' - 8" - VCP - 3.73%	336.5
21664SAGM	310' - 8" - VCP - 1.75%	311.3
21666SAGM	310' - 8" - VCP - 5%	310.1
21668SAGM	310' - 8" - VCP - 2.75%	310.6
21670SAGM	146.5' - 8" - VCP - 3.53%	148.0
21671SAGM	154.5' - 8" - VCP - 3.67%	155.2
21673SAGM	325' - 8" - VCP - 1.6%	326.1
21675SAGM	325' - 8" - VCP - 1.8%	327.8
21676SAGM	275' - 8" - VCP - 1.5%	270.7
21677SAGM	315.92' - 8" - VCP - 1.15%	316.7
21688SAGM	270' - 8" - VCP - 1.5%	271.7
21695SAGM	260' - 8" - VCP - 0.92%	259.6
21696SAGM	126' - 8" - VCP - 0.4%	125.7
21697SAGM	283' - 8" - VCP - 3.01%	286.6
21698SAGM	66' - 8" - VCP - 2.95%	65.1
21699SAGM	162.5' - 8" - VCP - 0.4%	163.3
21701SAGM	162.5' - 8" - VCP - 0.4%	164.1
21702SAGM	160.5' - 8" - VCP - 0.8%	162.8
21704SAGM	245' - 8" - VCP - 2.8%	245.1
21705SAGM	155' - 8" - VCP - 6%	155.2
21706SAGM	245' - 8" - VCP - 2%	244.9
21707SAGM	310' - 8" - VCP - 5.4%	309.4
21708SAGM	245' - 8" - VCP - 1%	245.4
21709SAGM	300' - 8" - VCP - 4.4%	301.3
21710SAGM	245' - 8" - VCP - 3%	245.4
21712SAGM	260' - 8" - VCP - 0.38%	260.1
21714SAGM	245' - 8" - VCP - 2.4%	246.0
21715SAGM	245' - 8" - VCP - 3%	245.0
21716SAGM	245' - 8" - VCP - 1%	246.2
21719SAGM	245' - 8" - VCP - 0.4%	244.1
21962SAGM	260' - 8" - VCP - 0.4%	260.0

## CHERRY CREEK EAST SANITARY IMPROVEMENTS - PIPE LABEL VS. GIS LENGTH

FACILITYID	PIPEINFO	SHAPE LENGTH
21968SAGM	186.54' - 8" - VCP - 0.4%	138.2
21969SAGM	40' - 8" - VCP - 0.4%	41.0
21971SAGM	252.5' - 8" - VCP - 0.72%	249.0
21973SAGM	255' - 8" - VCP - 0.4%	255.9
21974SAGM	255' - 8" - VCP - 0.4%	254.0
21975SAGM	255' - 8" - VCP - 0.4%	254.9
21977SAGM	255' - 8" - VCP - 0.4%	254.5
21983SAGM	255' - 8" - VCP - 0.4%	254.1
21984SAGM	255' - 8" - VCP - 0.4%	255.7
21985SAGM	256.38' - 8" - VCP - 0.4%	254.1
21986SAGM	255' - 8" - VCP - 0.4%	256.0
22003SAGM	81' - 8" - VCP - 0.4%	76.5
22006SAGM	106' - 8" - VCP - 0.57%	106.2
22007SAGM	120.32' - 8" - VCP - 1.35%	121.8
22008SAGM	255' - 8" - UNKN - 0.35%	254.9
22010SAGM	67.5' - 8" - VCP - 0.47%	65.4
22024SAGM	278.5' - 12" - VCP - 0.3%	280.5
22025SAGM	256.93' - 8" - VCP - 0.4%	257.2
22026SAGM	257.48' - 8" - VCP - 0.4%	257.5
22027SAGM	257.79' - 8" - VCP - 0.4%	260.0
22028SAGM	256.38' - 8" - VCP - 0.4%	259.5
22029SAGM	146.66' - 8" - VCP - 0.4%	147.3
22032SAGM	304.5' - 8" - VCP - 0.4%	302.9
22033SAGM	170' - 8" - VCP - 0.4%	170.5
22034SAGM	285' - 8" - VCP - 0.5%	279.4
22035SAGM	305' - 8" - VCP - 0.4%	304.6
22036SAGM	170' - 8" - VCP - 0.8%	167.3
22038SAGM	280' - 8" - VCP - 0.4%	281.6
22040SAGM	260' - 8" - VCP - 0.4%	263.3
22041SAGM	290' - 10" - VCP - 0.5%	292.8
22043SAGM	269.5' - 8" - VCP - 0.37%	202.9
22045SAGM	282' - 8" - VCP - 0.4%	282.7
22047SAGM	265' - 8" - VCP - 0.4%	261.6
22051SAGM	105' - 8" - UNKN - 0.85%	103.5
22052SAGM	39' - 8" - VCP - 0.48%	41.1
22053SAGM	218' - 10" - VCP - 0.48%	216.9
22054SAGM	184.5' - 10" - VCP - 0.4%	183.7
22055SAGM	263.5' - 8" - VCP - 0.4%	262.9
22056SAGM	275' - 8" - VCP - 0.4%	272.0
22058SAGM	63' - 8" - VCP - 0.41%	61.8
22060SAGM	265' - 8" - VCP - 0.4%	265.6
22061SAGM	212' - 8" - VCP - 0.4%	214.3
22064SAGM	78' - 10" - VCP - 0.31%	77.8
22065SAGM	260' - 8" - VCP - 0.8%	260.8

## CHERRY CREEK EAST SANITARY IMPROVEMENTS - PIPE LABEL VS. GIS LENGTH

FACILITYID	PIPEINFO	SHAPE LENGTH
22066SAGM	295' - 10" - VCP - 0.48%	295.1
22067SAGM	275' - 8" - VCP - 0.4%	278.5
22068SAGM	194' - 8" - VCP - 0.4%	192.6
22070SAGM	265' - 8" - VCP - 0.4%	263.9
22071SAGM	178.2' - 8" - VCP - 0.4%	178.2
22078SAGM	209' - 8" - VCP - 4.4%	209.5
22079SAGM	105.68' - 8" - VCP - 0.4%	105.7
22083SAGM	280' - 12" - VCP - 0.3%	271.4
22084SAGM	326' - 12" - VCP - 0.28%	324.0
22086SAGM	13' - 12" - VCP - 0.23%	14.5
22087SAGM	275' - 8" - VCP - 0.4%	275.2
22088SAGM	154.58' - 8" - VCP - 1.35%	152.4
22089SAGM	170' - 10" - VCP - 1.1%	169.4
22090SAGM	340' - 8" - VCP - 1.9%	283.3
22092SAGM	340' - 8" - VCP - 2.75%	269.6
22094SAGM	182' - 8" - VCP - 6%	181.6
22095SAGM	280' - 8" - VCP - 5.8%	279.9
22100SAGM	275' - 8" - VCP - 1.35%	276.4
22101SAGM	282.5' - 12" - VCP - 0.24%	275.3
22108SAGM	125' - 8" - VCP - 0.4%	124.9
22111SAGM	339' - 8" - VCP - 1.47%	339.0
22112SAGM	272.24' - 8" - VCP - 1.8%	272.6
22113SAGM	340' - 8" - VCP - 0.4%	340.3
22115SAGM	170.4' - 8" - VCP - 2.28%	174.2
22116SAGM	272.27' - 8" - VCP - 2%	271.6
22117SAGM	340' - 12" - VCP - 0.3%	336.3
22121SAGM	34' - 21" - VCP - 0.24%	33.3
22129SAGM	182.5' - 8" - VCP - 2.4%	183.2
22135SAGM	176' - 10" - VCP - 0.4%	175.0
22136SAGM	339.85' - 10" - VCP - 0.4%	339.9
22137SAGM	340' - 10" - VCP - 0.4%	340.5
22138SAGM	98' - 8" - VCP - 3.09%	97.9
22139SAGM	181' - 8" - VCP - 2.4%	176.4
22140SAGM	300' - 8" - VCP - 2%	298.5
22142SAGM	125.7' - 8" - VCP - 0.4%	124.0
22143SAGM	155.4' - 8" - VCP - 3.09%	156.7
22148SAGM	93.3' - 8" - VCP - 0.4%	93.7
22283SAGM	170' - 12" - VCP - 0.3%	171.6
22284SAGM	290' - 12" - VCP - 0.3%	274.9
22287SAGM	95' - 12" - VCP - 0.3%	91.1
22314SAGM	439' - 21" - VCP - 0.06%	61.8
23157SAGM	125.8' - 8" - VCP - 2.88%	124.8
23159SAGM	305' - 8" - VCP - 3.09%	306.2
23161SAGM	224' - 8" - VCP - 0.4%	223.2

## CHERRY CREEK EAST SANITARY IMPROVEMENTS - PIPE LABEL VS. GIS LENGTH

FACILITYID	PIPEINFO	SHAPE LENGTH
23163SAGM	268.77' - 8" - VCP - 1.34%	270.4
23165SAGM	242.5' - 8" - VCP - 1.17%	243.1
23167SAGM	224' - 8" - VCP - 0.4%	224.2
23171SAGM	210' - 8" - VCP - 0.4%	210.3
23172SAGM	213' - 8" - VCP - 0.4%	212.3
23174SAGM	268.77' - 8" - VCP - 1.34%	268.0
23177SAGM	287.5' - 8" - VCP - 2.13%	287.5
23179SAGM	287.5' - 8" - VCP - 3.74%	286.5
23181SAGM	287.5' - 8" - VCP - 3.27%	288.0
23187SAGM	287.5' - 8" - VCP - 2.13%	286.9
23189SAGM	287.5' - 8" - VCP - 3.27%	289.2
23190SAGM	287.5' - 8" - VCP - 3.74%	287.3
23194SAGM	245' - 8" - VCP - 0.45%	245.3
23198SAGM	288.12' - 8" - VCP - 0.4%	287.9
23200SAGM	174' - 8" - VCP - 3.89%	169.7
23205SAGM	270' - 8" - VCP - 2%	270.4
23206SAGM	270' - 8" - VCP - 4.5%	274.4
23207SAGM	265' - 8" - VCP - 1.5%	264.5
23209SAGM	108.8' - 8" - VCP - 2.96%	106.8
23211SAGM	177.3' - 8" - VCP - 0.4%	177.8
23216SAGM	340' - 12" - VCP - 2.05%	340.4
23218SAGM	340' - 12" - VCP - 2.75%	339.9
23219SAGM	340' - 12" - VCP - 2.4%	340.1
23221SAGM	340' - 15" - VCP - 2.21%	337.6
23240SAGM	245' - 8" - VCP - 0.45%	243.1
23242SAGM	17' - 8" - VCP - 2.52%	18.8
23246SAGM	287.5' - 8" - VCP - 0.4%	291.3
23247SAGM	293' - 8" - VCP - 0.52%	292.9
23252SAGM	124.08' - 8" - VCP - 0.6%	125.4
23253SAGM	115' - 8" - VCP - 0.48%	114.9
23254SAGM	100' - 8" - VCP - 0.4%	90.7
23255SAGM	96.18' - 8" - VCP - 3.1%	97.2
23257SAGM	280' - 8" - VCP - 0.5%	278.5
23258SAGM	210' - 8" - VCP - 0.5%	213.1
23593SAGM	32' - 8" - VCP - 2.3%	32.0
23602SAGM	287.5' - 8" - VCP - 2.18%	283.2
23607SAGM	235' - 8" - VCP - 4%	235.0
23609SAGM	315' - 8" - VCP - 3.3%	316.5
23611SAGM	252.5' - 8" - VCP - 2.18%	253.6
23612SAGM	200' - 8" - VCP - 4%	200.8
23618SAGM	353' - 8" - VCP - 2.3%	354.0
23619SAGM	287.5' - 8" - VCP - 2.48%	288.3
23621SAGM	287.5' - 8" - VCP - 2.35%	300.5
23625SAGM	287.5' - 8" - VCP - 2.18%	287.4



## CHERRY CREEK EAST SANITARY IMPROVEMENTS - PIPE LABEL VS. GIS LENGTH

FACILITYID	PIPEINFO	SHAPE LENGTH
23627SAGM	287.5' - 8" - VCP - 2.48%	287.5
23628SAGM	249.5' - 8" - VCP - 2.35%	263.3
23632SAGM	310' - 8" - VCP - 1.18%	309.9
23645SAGM	287.5' - 8" - VCP - 0.4%	285.7
23647SAGM	287.5' - 8" - VCP - 0.4%	285.2
23652SAGM	129.8' - 8" - VCP - 0.4%	127.6
23653SAGM	72' - 8" - VCP - 0.41%	71.5
23658SAGM	203.5' - 8" - VCP - 2.18%	207.1
23686SAGM	325.2' - 8" - VCP - 0.4%	324.1
23687SAGM	242' - 8" - VCP - 0.41%	245.5
23690SAGM	310' - 8" - VCP - 0.4%	303.8
23695SAGM	207' - 8" - VCP - 0.41%	205.0
23696SAGM	340' - 8" - VCP - 0.44%	340.6
23698SAGM	50' - 8" - VCP - 0.4%	57.5
23700SAGM	272' - 8" - VCP - 0.61%	279.5
23702SAGM	287.5' - 8" - VCP - 0.4%	287.2
23704SAGM	287.5' - 8" - VCP - 0.4%	289.6
23707SAGM	65' - 8" - VCP - 0.4%	64.7
23708SAGM	65' - 8" - VCP - 4%	63.9
23709SAGM	65' - 8" - VCP - 0.4%	65.8
23710SAGM	65' - 8" - VCP - 4.28%	67.5
23716SAGM	93.17' - 8" - VCP - 0.39%	92.7
23717SAGM	35' - 8" - VCP - 0.4%	38.2
23718SAGM	60.9' - 8" - VCP - 0.39%	55.1
23719SAGM	46.4' - 8" - VCP - 1.05%	46.4
23720SAGM	76.5' - 8" - VCP - 0.4%	75.5
23727SAGM	225' - 8" - VCP - 1.5%	227.6
23728SAGM	210' - 8" - VCP - 0.4%	211.3
23729SAGM	210' - 8" - VCP - 1%	210.8
23730SAGM	300' - 8" - VCP - 1.25%	300.2
23731SAGM	72' - 8" - VCP - 1.75%	73.2
23732SAGM	125' - 8" - VCP - 17.52%	123.2
23734SAGM	145.83' - 8" - VCP - 1.5%	142.7
23741SAGM	317.1' - 8" - VCP - 1.74%	311.6
23742SAGM	166.41' - 8" - VCP - 0.4%	162.0
23743SAGM	60.95' - 8" - VCP - 0.86%	67.4
23749SAGM	217.5' - 8" - VCP - 0.4%	216.3
23750SAGM	162.5' - 8" - VCP - 0.6%	163.7
23751SAGM	292.5' - 8" - VCP - 1.25%	294.3
23752SAGM	325' - 8" - VCP - 0.6%	329.5
23753SAGM	178.16' - 8" - VCP - 0.75%	176.1
23754SAGM	217.5' - 8" - VCP - 1%	220.7
23755SAGM	217.5' - 8" - VCP - 1.5%	218.0
23757SAGM	206' - 8" - VCP - 1.75%	205.6

## CHERRY CREEK EAST SANITARY IMPROVEMENTS - PIPE LABEL VS. GIS LENGTH

FACILITYID	PIPEINFO	SHAPE LENGTH
23758SAGM	294.64' - 8" - VCP - 2.05%	296.7
23761SAGM	278' - 8" - VCP - 0.66%	276.8
23765SAGM	276' - 8" - VCP - 1.23%	274.8
23766SAGM	210' - 8" - VCP - 0.7%	211.2
23767SAGM	210' - 8" - VCP - 0.84%	211.6
23771SAGM	275' - 8" - VCP - 0.8%	275.1
23776SAGM	285' - 8" - VCP - 2.9%	285.3
24254SAGM	119.43' - 18" - VCP - 0.45%	121.7
24256SAGM	10' - 12" - VCP - 0.24%	14.5
24292SAGM	35.9' - 8" - VCP - 0.4%	41.6
24369SAGM	13.24' - 8" - UNKN - 0.41%	13.2
24434SAGM	38' - 8" - VCP - 2.35%	29.1
481285SAGM	192.83' - 8" - VCP - 3.19%	193.9
481286SAGM	60.89' - 8" - VCP - 3.19%	61.2



CITY AND COUNTY OF DENVER  
DEPARTMENT OF PUBLIC WORKS, ENGINEERING DIVISION

## Wastewater Capital Projects Management Standard Construction Specification

---

### 10.7 Cured In Place Pipe

#### 10.7.1 General

This section outlines the guidelines & requirements for the rehabilitation of pipelines and conduits by the Cured in Place Pipe Method (CIPP). CIPP is the installation of a resin-impregnated flexible tube which is inserted into an existing conduit and cured by the use of pressurized steam or circulated water under a hydrostatic head. When complete, the CIPP is continuous and fits tightly to the existing pipe.

#### 10.7.2 Referenced Standards

This section references American Society for Testing and Materials (ASTM) standards, which are made a part of this specification by such reference. All standards shall be the latest edition and revision. The materials, manufacturing, operations, testing, inspection and production of cured in place pipe shall conform to the following standards.

ASTM D638	Standard Test Method for Tensile Properties of Plastics
ASTM D790	Standard Test Methods for Flexural Properties of Unreinforced and Reinforced Plastics and Electrical Insulating Materials
ASTM D2122	Determining Dimensions of Thermoplastic Pipe & Fittings
ASTM D2990	Standard Test Methods for Tensile, Compressive, and Flexural Creep and Creep-Rupture of Plastic
ASTM D5813	Standard Specification for Cured-In-Place Thermosetting Resin Sewer Piping Systems
ASTM F1216-09	Standard Practice and Rehabilitation of Existing Pipelines and Conduits by the Inversion and Curing of a Resin-Impregnated Tube
ASTM F1743	Practice of Rehabilitation of Existing Pipelines and Conduits by Pulled-In-Place

**ASTM F2019 Standard Practice for Rehabilitation of Existing Pipelines and Conduits by the Pulled in Place Installation of Glass Reinforced Plastic (GRP) Cured-in-Place Thermosetting Resin Pipe (CIPP)**

### **10.7.3 Submittals**

Unless otherwise specified, the Contractor is responsible to have all submittals transmitted to the Construction Project Manager in sufficient time to allow two weeks for review and acceptance prior to starting the construction or any work by the Contractor. These include, but are not limited to:

- CIPP Health and Safety Plan
- Confined Space Entry Permits
- Corrosion Testing.
- Employee Certifications (NASSCO, OSHA, etc.)
- Felt Certification
- Fire Department Permit
- Installation Procedures
- Laboratory Designation and Accreditation
- Laboratory Testing Results
- Liner and Resin Long Term Performance Studies in Post-installation
- Service Open Notice
- Pre-cleaning (and TV) Notice
- Pre-lining Notice
- Pulling force gauge
- Structural Requirements
- Technical Supervision
- Tube Compliance
- Unanticipated Cancellation Notice
- Video/log sheet sample

#### **10.7.3.1 Installation**

Prior to installation by Inversion or the Pulled-in-Place method, the Contractor shall provide the Construction Project Manager with the following as applicable to the specific installation method:

- a. The minimum pressure required to hold the tube tight against the existing conduit and the maximum allowable pressure so as not to damage the tube. A complete log of the pressure (or head level) shall be maintained on the site and be furnished to the Construction Project Manager after each installation.
- b. The maximum allowable force that can be used in pulling the tube into the existing pipeline for each size of line. A complete log of the pulling force used for each line shall be maintained on site by the Contractor and be furnished to the Construction Project Manager after each installation.
- c. Minimum temperature and time required for cure on each size of line, based on installation method.

- d. For CIPP segments which are wet out on site, the Contractor must also submit (in spreadsheet form) information on allowable head pressure, roller spacing and gallons of resin to felt length with respect to diameter so the procedure can be verified on site.

### **10.7.3.2 Health and Safety Plan**

Prior to site work, the Contractor shall provide the Construction Project Manager, for review, a Health and Safety Plan which includes (at a minimum) the following:

#### I) Introduction

- a. Provide project description, the work location and summary of key work activities to be performed.

#### II) Scope and Applicability

- a. Describe the scope of work for the General Contractor and 1<sup>st</sup> tier subcontractors performing the work
- b. Detail the planned site activities
- c. Describe who must adhere and abide by the Health and Safety plan
- d. Detail how site visitors will be addressed

#### III) Key Personnel, Responsibilities and Authority

- a. In relation to Health and Safety, describe the role of project managers, health and safety managers, technical supervisors (10.7.3.4), and other contractor and subcontractor staff.
- b. Provide resumes of Key Personnel, including background and training history.
- c. Identify the name, title, and contact information (phone, email, address) for key personnel.
- d. Identify the name, location, and contact numbers for ambulance, fire, police, hospital, Health and Safety managers (contractor and/or subcontractors), and other key personal or support contacts.

#### IV) Task/Operation Health and Safety Risk Analysis

- a. Identify, on a task specific basis the individual hazard elements that are present including chemical, physical, and biological.

#### V) Qualifications and Training Requirements for all Personnel

- a. Detail specific qualifications and training that are required.
- b. Discuss the frequency of safety and training refreshers.
- c. Detail the requirement for site personnel to read and acknowledge, in writing, their understanding of the Health and Safety plan.

#### VI) Engineering and Administrative Controls

- a. Describe in detail how engineering and administrative controls will be used to protect worker and public safety by preventing chemical exposure, injury, or illness.
- b. List controls in conjunction with each activity identified in the Task/Operation Health and Safety Risk Analysis section above.

#### VII) Personal Protective Equipment (PPE) Requirements

- a. PPE requirements should be listed in conjunction with each activity identified in the Task/Operation Health and Safety Risk Analysis.
- b. Detail applicable standards (e.g., ANSI, NIOSH, ACGIH, OSHA etc)

#### VIII) Health and Safety Monitoring

- a. Detail instruments, samples, and monitoring that will occur both on the jobsite and in response to complaint(s) or inquiries.
- b. Detail who is responsible for performing monitoring
- c. Detail frequency of monitoring
- d. Define the appropriate action levels and thresholds
- e. Describe standard operating procedures for Health and Safety monitoring

#### IX) Site control

- a. Describe work zones, buddy systems, and site security.
- b. Address policies including drug and alcohol policies, personal hygiene requirements, heat and cold stress prevention
- c. Describe task specific site control (e.g., confined space entry protocol, worker photo ID program, etc.)

#### X) Decontamination plan

- a. Eye and hand wash (if applicable)
- b. Site cleanup

#### XI) Emergency Contingency Plan

- a. Medical services
- b. Emergency phone numbers
- c. Personnel Injury
- d. Fire/Explosion
- e. Hazardous Material spill response and onsite location of spill kit
- f. Evacuation
- g. Emergency signals and communication

- h. First aid
- i. Emergency equipment list
- j. Map(s), addresses, and phone numbers of nearest medical facilities

#### XII) Appendices

- a. Safety forms (as needed)
- b. Supporting documentation and information
- c. Material safety data sheets (MSDS)

#### **10.7.3.3 Weekly Installation Schedule**

The Contractor shall submit a weekly construction schedule, 7 calendar days in advance of the work, to the Construction Project Manager and the Denver Fire Department to include the following information:

1. The specific line number and related manhole numbers as designated in the project plans. The line length and service connection count information must also be included from the preliminary video investigation.
2. The specific date and timeframe each installation will occur. Night and weekend work must be approved by the Construction Project Manager a minimum of 10 days prior to the proposed commencement of the work.
3. The Technical Supervisor's name for the crew(s) that will be doing each specific installation.
4. The method of installation planned for each line in accordance with ASTM F1216 or F1743.
5. The location and schedule of the "wet-outs" in order to permit inspection of the materials and procedures. This information may be submitted separately.

#### **10.7.3.4 Technical Supervision**

Due to the technical aspects and complexity of the products used during the installation of CIPP, the Contractor is required to maintain a full time employee with a minimum of five years experience in the CIPP process of rehabilitation. This employee should be at the superintendent level or higher. This employee must be the direct, first line contact for all aspects of the project construction management. Resume and references, and copies of applicable required NASSCO, OSHA, etc. training certificates of this employee shall be submitted to the Construction Project Manager for review and acceptance prior to the start of the project.

#### **10.7.3.5 Test Results and Performance Studies**

CIPP sample test results as well as long term performance studies, from an industry recognized independent laboratory, must be submitted for the materials from the specific supplier(s) to be used on the project in accordance with applicable ASTM standards. The CIPP liner material must meet the requirements of ASTM F1216 or F1743 and ASTM D5813 Sections 6 and 8 (Appendix X.1). The resin shall produce CIPP, which will comply with the

structural and chemical resistance requirements of ASTM F1216 or F1743. It is required that CIPP samples with and without polyethylene coating meet these chemical testing requirements. The long term performance studies must show the proposed material consistently meets the required thickness and strength requirements per the Contract Documents.

The Long Term Performance Studies must be submitted and accepted prior to bidding to pre-qualify the prospective bidder. The CIPP liner material used for the project must be the exact same composition of the material used in the Long Term Performance Studies as outlined in this Section. Any deviation in the composition will require that a new Long Term Performance Study is completed, submitted and accepted prior to installation.

### **10.7.3.6 Street Occupancy Permits**

The Contractor shall submit, to the Construction Project Manager, copies of the street occupancy permits, including the approved traffic control plans prior to beginning work.

### **10.7.3.7 Digital Video and Log Sheets**

Prior to commencing any site work, the contractor shall submit video quality samples as well as log sheet samples for review and acceptance by the Construction Project Manager. These samples must be in accordance with the following specifications.

### **10.7.3.8 Digital Video and Log Sheets Specifications**

1. After cleaning and lining, the manhole sections shall be visually inspected by means of closed-circuit television. The inspection will be done one manhole section at a time and the flow in the section being inspected will be suitably controlled as specified elsewhere in these Standard Construction Specifications. CCTV inspections shall be performed in accordance with PACP standards including indications of the specific date and time of inspection.
2. The closed-circuit television camera used for the inspection shall be one specifically designed and constructed for such inspection. Lighting for the camera shall be suitable to allow a clear picture of the entire periphery of the pipe. The camera shall be operative in 100% humidity conditions. The camera, television monitor, and other components of the video system shall be capable of producing picture quality to the satisfaction of the Owner's Representative; and if unsatisfactory, equipment shall be removed and no payment will be made for an unsatisfactory inspection.
3. The camera shall be moved through the line upstream to downstream at a moderate rate, stopping when necessary to permit proper documentation of the sewer's condition. In no case will the television camera be pulled at a speed greater than 30 feet per minute. Manual winches, power winches, TV cable, and powered rewinds or other devices that do not obstruct the camera view or interfere with proper documentation of the sewer conditions shall be used to move the camera through the sewer line. If, during the inspection operation, the television camera will not pass through the entire line section, the Contractor shall set up his equipment so that the inspection can be performed from the opposite manhole. If, again, the camera fails to pass through the entire manhole section, the inspection shall be considered complete noted as Survey Abandoned. The contractor is required to notify the Construction Project Manager and further direction will be provided.



4. When manually operated winches are used to pull the television camera through the line, telephones or other suitable means of communication shall be set up between the two manholes of the section being inspected to ensure good communications between members of the crew.

5. The importance of accurate distance measurements is emphasized. Measurement for location of defects shall be above ground by means of a meter device. Marking on the cable, or the like, which would require interpolation for depth of manhole, will not be allowed. Accuracy of the distance meter shall be checked by use of a walking meter, roll-a-tape, or other suitable device, and the accuracy shall be satisfactory to the Construction Project Manager.

6. Documentation of the television results shall be as follows:

(6.1) Television Inspection Logs: Electronic media location records shall be kept by the Contractor and will clearly show the location, by distance in 1/10 of a foot or nearest cm, from the upstream manhole wall, in relation to an adjacent manhole of each infiltration point observed during inspection.

In addition, other points of significance such as locations of building sewers (taps), unusual conditions, roots, storm sewer connections, cracks, fractures, broken pipe, presence of scale, calcium deposits and corrosion (with estimated thicknesses), and other discernible features, as defined in the PACP defect codes, will be recorded on electronic media, and a copy of such records will be supplied to the Construction Project Manager.

(6.2) Digital photographs of the pipe condition and all defects and service connections (taps) shall be taken by the Contractor. Photographs shall be located by distance in 1/10 of a foot or nearest mm, from the manhole wall, in relation to an upstream manhole.

(6.3) Electronic media recordings: The purpose of electronic media recording shall be to supply a visual and audio record of problem areas of the lines that may be replayed by the Owner. Each original electronic media recording of conditions and defects will be delivered to the Project Construction Manager upon completion of a specific line section.

(6.4) All CCTV Inspection shall be performed by CCTV personnel who are trained and certified in the use of NASSCO's Pipeline Assessment and Certification Program (PACP)©.

### **10.7.3.9 Digital Video and Log Sheets Submittal Naming Convention**

The Contractor shall submit all log sheets and digital video files for pre- and post-installation, together, the week immediately following completion of each work segment. All digital video and log sheets must be submitted electronically, *on a USB Plug and Play device (flash drive or hard drive)*. *Video shall be in MP4 format and logs shall be in .pdf format* All video and logs shall be submitted utilizing the following naming convention:

- a. Video Files and Log Sheets
  - i. Named using the following items sequentially, followed by a space

1. City of Denver Contract Number
2. Line Number From Plans
3. GIS Facility ID From Plans (for each line segment.)
4. Type Of File ('Pre' or 'Post' for Video, 'Pre Log' or 'Post Log' for applicable log sheets)
5. Extension of file (.mp4 or .pdf)

ii. Examples:

1. 2012XXXXX Line72 31814SAGM Post Log.pdf
2. 2012XXXXX Line72 31814SAGM Post.mp4
3. 2012XXXXX Line72 31814SAGM Pre Log.pdf
4. 2012XXXXX Line72 31814SAGM Pre.mp4
5. 2012XXXXX Line73 31825SAGM Post Log.pdf
6. 2012XXXXX Line73 31825SAGM Post.mp4

## 10.7.4 Materials

### 10.7.4.1 Textile Tube

1. The tube shall meet the requirements of ASTM F1216 or F1743 and ASTM D5813 Sections 6 and 8. The finished CIPP shall be fabricated from materials which when cured will be chemically resistant to withstand internal exposure to all types of sewage being conveyed. The textile tube shall be continuous in length for the associated run. The wet-out textile tube shall meet ASTM F1216 or F1743, as applicable, have sufficient strength to bridge missing pipe segments and have a uniform thickness that when compressed at installation pressure will equal the specified nominal tube thickness, with a -5% manufacturing tolerance allowed. The tube shall be fabricated to a size that, when installed, will tightly fit the internal circumference and length of the original pipe. For pulled-in place installation, the fabric tubes shall conform to ASTM F2019-5.2.1. Allowance should be made for circumferential stretching during installation. The minimum length shall be that deemed necessary by the Contractor to effectively span the distance between respective access points, unless otherwise specified. It is the Contractor's responsibility to verify the CIPP lengths and diameters in the field before fabricating the tube.
2. Prior to installation the outside layer of the tube shall be coated with a translucent plastic coated flexible material that clearly allows inspection of the resin impregnation, or wet-out procedure. The plastic coating shall not be subject to delamination after curing of the CIPP. The tube shall be homogenous across the entire wall thickness containing no intermediate or encapsulated elastomeric layers. No materials shall be included in the tubes that are subject to delamination from the cured CIPP.
3. The wall color of the interior pipe surface of the CIPP after installation shall be notably colored as seen in the field install to ensure that the resin has been fully impregnated so that a clear and detailed examination with closed circuit television inspection equipment may be made.
4. The wet-out textile tube shall meet ASTM F1216 or F1743, as applicable, shall have a

uniform thickness and 5% to 10% excess resin distribution that when compressed at installation pressures will meet or exceed the design thickness after the cure.

#### 10.7.4.2 Resin

1. The resin/liner system shall conform to ASTM D2990 and ASTM D5813 Section 8.2.2 – 10,000-hour test.
2. The resin shall be a general purpose, unsaturated, styrene-based, thermoset resin and catalyst system or epoxy resin and hardener that are compatible with the inversion or pulled in place process as per the requirements of ASTM F1216 or F1743. The resin shall be tinted so that adequate saturation can be readily observed. Only resin with a minimum long term (50 years) Modulus of Elasticity of 48% of the initial Modulus of Elasticity will be accepted.
3. The tube shall be impregnated with sufficient amount of resin to ensure that the resin will be observed on the outer surface of the tube when squeezed. After the tube is cured, it shall show satisfactory evidence of a fully impregnated tube or the existence of excess resin on the outer surface.

#### 10.7.4.3 Calibration Hose

If a calibration hose is required to be used during the process of the installation of the CIPP, the hose shall be wet and vacuum impregnated with sufficient amount of resin prior to inversion to prevent delamination after the curing of the CIPP. Delaminating or failure of the calibration hose will be cause for rejection or complete removal of the CIPP section at the discretion of the Construction Project Manager.

#### 10.7.4.4 Structural Requirements

1. The CIPP shall be designed as per ASTM F1216, Appendix X.1. The CIPP design shall assume no bonding to the original pipe wall, a fully deteriorated condition, 5% ovality and a conservative groundwater presence over the pipeline. The CIPP cured thickness must meet the required minimum cured nominal thicknesses specified in the table below, or for pipe larger than 18-inches in diameter as specified within the Contract Documents.

Internal Pipe Diameter (inches)	CIPP Minimum Cured Nominal Thickness (mm) Based on Modulus of Elasticity Values	
	Modulus of Elasticity (E) 250,000 psi	Modulus of Elasticity (E) 400,000 psi
8	6	5
10	7.5	6
12	9	7.5
15	10.5	9
18	12.5	10.5
For pipe larger than 18-inches in diameter, the CIPP minimum nominal thickness is specified within the Contract Documents		

2. The layers of the cured CIPP shall be uniformly bonded. It shall not be possible to separate any two layers with a probe or point of a knife blade so that the layers separate cleanly or the probe or knife blade moves freely between the layers; nor shall separation of the layers occur during the required testing.
3. The cured pipe material (CIPP) shall conform to the minimum structural standards, as listed below:

Flexural Stress	ASTM D790	4,500 psi
Modulus of Elasticity	ASTM D790	250,000 or 400,000 psi
Tensile Strength	Pressure Pipe - ASTM D638	3,000 psi

Either of the listed Modulus of Elasticity values noted may be used as long as minimum nominal thicknesses are adhered to in accordance with the table or as noted within the Contract Documents.

## 10.7.5 Quality Control

It shall be the contractor’s responsibility to ensure that the CIPP installed on the project meets all requirements of the Contract Documents and that the final product provided to the City meets all of the City and County of Denver Specifications and is of the highest quality possible.

### 10.7.5.1 Testing

In the event that the results of any tests do not meet the requirements of the Contract Documents and/or referenced ASTM standards, the Contractor may proceed with the work at his/her own risk and will be required to submit to the Construction Project Manager the proposed changes in the process to meet the required properties of the CIPP.

If any lined pipe segment fails to meet the required properties, the Contractor's attention is directed to General Condition 304 – “Substituted Performance”. At the discretion of the Construction Project Manager and at the Contractor’s own expense, the Contractor will be required to remove and replace any lined pipe segment, without damaging the host pipe, or install another liner inside of the liner that failed in order to meet the specified requirements of the Contract Documents

The City may elect at any time to decrease or increase the frequency of these sample and testing requirements.

#### 10.7.5.1.1 On-Site Thickness Testing

A minimum of 2 (two) samples will be collected or 2 locations tested using ultrasonic methods, for on-site thickness at each installation by the contractor. All samples collected for testing shall be restrained with equivalent diameter pipe to match the actual field installed

liner. A minimum of eight measurements at evenly spaced intervals around the circumference (internal or external based on method) of the pipe will be made to ensure that minimum and maximum thicknesses have been achieved. For pipe diameters fifteen inches or greater, a minimum of sixteen evenly spaced measurements shall be recorded. Any plastic coatings or CIPP layers not included in the structural design of the CIPP must be deducted from the measured thickness value. The average thickness will be calculated using all measured values and shall meet or exceed the minimum required design thickness. Additionally, the minimum wall thickness measured at any one point around the circumference shall not be less than 87.5% of the specified design thickness as specified within the Contract Documents.

The wall thickness will be measured in accordance with the applicable sections of ASTM D2122 or ASTM E797 and shall incorporate the following, as applicable:

1. For onsite samples collected for testing: A cylindrical anvil tubing micrometer accurate to +0.02 mm (+0.001 inch) will be used. The minimum wall thickness tests will be performed by the Construction Project Manager (or assigned field representative) from the two samples at each installation. All costs associated with providing the required samples shall be borne by the Contractor.
2. For onsite testing using Ultrasonic methods: Testing will be performed by the ultrasonic pulse echo method, in accordance to ASTM E797. Measurements will be taken and calculated at both ends of the pipe run, around the internal circumference of the installed CIPP and at a distance of 12 to 18 inches from the end of pipe, as noted in item 1 above. The ultrasonic method will utilize a flaw detector with A-scan display and a direct thickness readout as defined in 6.1.2 of ASTM E797. A calibration block shall be manufactured from the identical materials used in the installed CIPP to calibrate sound velocity through the liner. Calibration of the transducer shall be performed daily in accordance with the equipment manufacturer's recommendations.

If the deviation in thickness of any one sample is less than 5% (five percent), no payment adjustment will be required. If the deviation in thickness is measured to be between 5%-10% (five percent and ten percent) an adjustment of 10% (ten percent) reduction of the liner unit bid cost will be applied. If the deviation in thickness is greater than 10% (ten percent), the entire run will be rejected and removed and replaced solely at the Contractor's expense.

#### **10.7.5.1.2 Allowable Pulling Force**

Prior to installation, the Contractor shall submit to the Construction Project Manager the maximum allowable force, per the material manufacturer, that can be used in pulling the tube into the pipe without rupturing or diminishing the diameter and/or the thickness of the tube. Such pulling force shall be monitored at all times during the installation operation with a gauge that is available for viewing by the City and the tube shall be rejected and removed if the allowable pulling force is exceeded.

#### **10.7.5.1.3 Allowable Elongation of Flexible Tube**

Prior to installation, the flexible tube shall be measured and marked equal to the

installation run (distance between manholes less one manhole diameter). After the completion of installation, the length of the flexible tube outside of the installation run (face of the manhole to the mark) shall be measured. This length or elongation shall not exceed 3% (three percent) of the original length of measured flexible tube. In the event that this length is exceeded, the entire run length may be rejected and permanently discarded, the Construction Project Manager may order an additional tube to be inserted at no cost to the City, or may accept the elongated tube, but reduce the price paid for the work by 5% (five percent) for every percent elongation above the 3% (three percent) allowable tolerance, as provided by General Condition 304, Substituted Performance. Acceptance will be at the sole discretion of the Construction Project Manager.

#### **10.7.5.1.4 Laboratory Testing**

At the start of construction, at least two restrained CIPP field samples will be taken and submitted for laboratory testing. CIPP samples shall be prepared and tested in accordance with ASTM F1216 or ASTM F2019. These samples will be taken by the approved independent lab, with chain of custody documentation regarding each sample.

A CIPP sample is required to be prepared for each installation segment, using one of the following two methods (depending on the size of the host pipe):

1. For pipe sizes of 18 inches or less: the sample will be cut from a section of cured CIPP at an intermediate manhole or at the termination point. If the sample is taken at a termination point the CIPP must have been inverted through a restrained, like diameter pipe which has been held in place by a suitable heat sink, such as sandbags.
2. For pipe sizes greater than 18 inches and areas with limited access: the sample must be fabricated from material taken from the tube and the resin/catalyst system used. This fabricated sample must be cured in a clamped mold which is placed in the down tube (when curing using circulating hot water) or in the silencer (when curing using steam). If approved by the Construction Project Manager, this method can be used for preparing a test sample on any size of CIPP in situations where preparing samples in accordance with section F1216-09, sec. 8.1.1 is not possible due to physical constraints.

Samples must identify the City contract number, project name, line number, date sample was taken and the specified thickness requirement. Testing for cured liner thickness, modulus of elasticity, flexural stress and tensile strength shall be performed by a Certified Independent laboratory approved by the Construction Project Manager. Test results are to be submitted to the Construction Project Manager and all costs of tests shall be included in the related bid price unless specified elsewhere in the Contract Documents. The Contractor shall take samples from the first week's installation and have the short term tests completed and results to the Construction Project Manager prior to application for the first pay estimate. Additional testing will commence at intervals required by the Construction Project Manager.

Additional laboratory testing, at the City's expense, may be requested as frequently as every CIPP installation, at the discretion of the Construction Project Manager. The

Contractor will be reimbursed for additional testing at the Contract unit bid price. At the option of the Construction Project Manager any sample taken by the Contractor may be sent to an independent laboratory for similar testing.

#### **10.7.5.1.5 Infiltration Test**

If the ground water level is above the top of the pipe throughout the length being reconstructed, the Construction Project Manager, at his/her discretion, may order that an infiltration test be performed. The maximum allowable infiltration shall be 50 gal per day/inch dia/mile (.95 gpd/inch/100 ft.). If the infiltration is found to exceed the prescribed amount, the Contractor shall make the appropriate repairs as approved by the Construction Project Manager. Additional infiltration tests will be performed until acceptable results are obtained.

Unless otherwise specified, infiltration will be measured by a subcontractor specializing in CIPP testing who is mutually agreed upon by the City and Contractor. Payment for this testing is at the City's expense and will be handled by change order.

#### **10.7.5.1.6 Exfiltration Test**

In the absence of ground water, the Construction Project Manager, at his/her discretion, may order an exfiltration test be performed in accordance with these specifications. The allowable rate of exfiltration shall be equal to the limits of infiltration stated above. Each section of CIPP will be tested between successive manholes by closing the lower end of a sewer and the upper manhole(s) to the proper level with water. The water level in the upper manhole shall be a minimum of 4 feet above the level of the ground water.

For the purposes of exfiltration leakage, manholes shall be considered to be equivalent length of pipe equal to the diameter of the manhole (i.e. 48, 60 or 72 inch diameter). Air pocket entrapment shall be avoided when filling the line with water. Once filled with water, the system shall be allowed to stabilize for a period of two hours before starting the test. Exfiltration leakage rate is determined by measuring the amount of water required to maintain a constant level in the upper manhole. Test duration is to be no less than two hours.

If the leakage, as shown by the test, exceeds the allowable value, the Contractor shall make the necessary correction at his expense to reduce the exfiltration to within the permissible limits. The Contractor shall furnish all water, material and labor required to perform the test. All tests shall be made in the presence of the Construction Project Manager.

### **10.7.6 Public Information and Notification**

All written notices shall be issued on current City and County of Denver letterhead templates, prepared in a professional manner and must be approved by the Construction Project Manager prior to distribution. All contact with the Public shall be executed in a business professional manner, including adhering to professional standards regarding courtesy, grooming and maintaining visible/legible photo identification.

1. The Public Information and Notification program shall at a minimum, require the Contractor to be responsible for contacting each home or business affected by the sewer construction and informing them of the work to be done in all of the following

ways: Written notice shall be delivered a minimum of 48 hours in advance of the Pre-clean and Video; and again on the day of installation, to each home or business describing the work, schedule, how the construction affects them, and a local telephone number of the Contractor they can call to discuss the project or any problems that may arise.

2. Personally contacting each home and business owner on the day of pre-installation inspection of the sewer and coordinating with that owner the verification of their existing service connection. If the owner is unavailable, other arrangements shall be made for existing service connection verification.
3. In the event that a written notice cannot be left at the home or business, the contractor shall personally contacting each home or business owner the day prior to beginning work on the section of sewer to which they are connected.
4. Personally contacting any home or business owner which cannot be reconnected within the time stated in the Written Notice. Anticipated service tap reconnection time shall be noted within another notice.
5. Provide written notice with the time of reactivation posted on the front door of a residence or business.
6. Upon request by residents and businesses affected by the work, portable toilets shall be furnished and serviced by the Contractor. Reimbursement for the costs of these items will be covered through change order with the Construction Project Manager. Businesses which require special accommodations, such as night or weekend work, must be identified at least 10 days prior to the proposed scheduled work. The Construction Project manager shall be notified and kept apprised of the coordination to meet these special accommodations.

## **10.7.7 Installation**

### **10.7.7.1 Access Points**

The City has shown all existing manhole access points on the Contract Documents, to the best of its knowledge. It is the Contractor's responsibility to fully examine the project site to verify the location of existing manholes and to determine if all manholes are accessible, as necessary for completion of the work. It will be the Contractor's responsibility to notify the Construction Project Manager far enough in advance of the CIPP lining process to allow time for the City to make necessary repairs and provide access to the manholes that are not accessible. The Contractor will reschedule the work as needed so that repair work, either by the City or by the Contractor, can be completed.

### **10.7.7.2 Pre-Installation Inspection**

Inspections of pipelines shall be performed by experienced personnel trained in locating and identifying defects, breaks, obstacles, and service connections by closed circuit television. Certification by NASSCO, PACP program is preferred for inspection personnel. The pre-inspection of pipelines shall also determine active service connections, the



addresses served (both visible on the digital recording and audible), as well as which service connections are opened, capped or misaligned. Only active service connection and laterals shall be re-established unless directed otherwise by the Construction Project Manager. For UV-lining, visible indentations may not be readily identifiable, so the measurement to services shall be noted in a log, as well as the clockwise position of the opening.

The interior of the pipeline shall be carefully inspected to determine the location of any conditions which may prevent proper installation of the CIPP. It is the Contractor's responsibility to notify the Construction Project Manager of any conditions which may prevent proper installation of the CIPP. These types of conditions shall be recorded and submitted digitally, as described elsewhere in these specifications, to the Construction Project Manager within 5-calendar days of observance, to allow for remedial action and rescheduling of installation for that section of CIPP.

### **10.7.7.3 Bypassing Sewage**

The Contractor shall provide for the flow of sewage around the section or sections of pipe designated for reconstruction. All costs incurred for bypass pumping are included within the "Cured-In-Place-Pipe" bid item within the contract, except when otherwise noted. The bypass shall be made by plugging the line at an existing upstream manhole or adjacent system. The pump and bypass lines shall be of adequate capacity and size to handle the flow with backup pumps onsite. Bypass pumps must be monitored at all times. Leaking equipment will not be permitted. Bypass pumping must be provided for all mainline and service line flows affected by construction. Wastewater shall not be allowed to spill into storm drains, street gutters, or open excavations. Any spills that occur must be addressed immediately and in full conformance with local regulations and requirements. The Construction Project Manager shall be notified immediately and the Contractor shall bear all costs associated with any spills.

### **10.7.7.4 Cleaning of the Sewer Line**

The Contractor shall be required to remove all existing internal debris from the sewer line with the use of water jet, and/or grinding equipment that is accepted by the Construction Project Manager. The cleaning operation shall remove any and all existing debris so that each pipe joint can be thoroughly inspected and successfully reconstructed or rehabilitated. Excessively hard deposits that cannot be removed by regular cleaning equipment or grinding which require special tools to remove will be paid for negotiated separately by the City.

All sludge, dirt, sand, rocks, grease, and all other solid or semi-solid material resulting from the cleaning operation shall be removed at the downstream manhole of the section being cleaned. Passing material from one manhole section to another shall not be permitted.

All such debris resulting from cleaning operations shall be removed from the site and disposed of in a proper manner. The Contractor shall bear all costs associated with testing of debris and proper dumping. Dumping of the debris shall be in accordance with all local, state, and federal regulations. The City will negotiate for costs associated with material disposal if Hazardous Wastes are encountered during testing.

At the end of each work day, all debris shall be removed from the downstream manhole

and from the construction site. No debris shall be left at the construction site unattended by the Contractor. Under no circumstances will the Contractor be allowed to accumulate debris beyond the stated time limit. In the event the Contractor leaves debris unattended at the construction site beyond the stated time, the Contractor will not be allowed to proceed with the work until the debris is properly removed.

During all sewer cleaning operations, precautions shall be taken to protect the sewer lines from damage that might be inflicted by improper use of cleaning equipment. Precautions shall be taken to ensure that the cleaning operation will not cause any damage or flooding to public and/or private property being served by the sewer line section involved. The Contractor shall bear all costs associated with flooding, damage to basements or structures, adjacent utilities and the City's sewer.

#### **10.7.7.5 Line Obstructions**

It shall be the responsibility of the Contractor to clear the line of obstructions such as solids and roots that will prevent the installation of the CIPP. If the pre-installation inspection reveals an obstruction such as a protruding service connection, dropped joint, collapse or obstruction that will prevent the rehabilitation process and cannot be removed by conventional sewer cleaning equipment, grinding or extended tap cutting, then the Contractor shall notify the Construction Project Manager immediately. These conditions shall be recorded and a digital video file and log sheet must be submitted to the Construction Project Manager so that the existing conditions are documented and may be reviewed to determine the extent of repair required prior to CIPP installation. The Construction Project Manager will notify the Contractor upon completion of required repair(s), at which time the Contractor shall perform sewer line cleaning and a pre-installation inspection prior to CIPP installation.

#### **10.7.7.6 Methods**

All bidders proposing to use the CIPP process for a project must use a method that has been approved by the City prior to bid opening. All approved CIPP methods must meet these Standard Construction Specifications. Any proposed deviation from these Standard Construction Specifications must be submitted in writing for acceptance at least eight calendar days prior to the bid opening. CIPP installation shall be in accordance with ASTM F1216, Section 7 for the Inversion Method, or Section 6 of ASTM F1743 for the Pulled-In-Place Installation Method, with the following requirements:

1. The Contractor shall designate a location where the tube will be impregnated prior to installation. The Contractor shall notify the Construction Project Manager of proposed "wet-outs" in order to inspect the materials and procedure. A resin and catalyst system compatible with the requirements of this method shall be used.
2. Once inversion has started, the pressure shall be maintained between the minimum and maximum pressures, as set by the liner's manufacturer, until cure completion. A continuous, constant pressure must be maintained for all air inversion steam cure (AISC) installations. If pressure is lost at any time during installation/cure (for inversion or pulled in place methods), the City may request that the CIPP product be removed and the line segment re-inspected, at the contractor's expense, prior to allowing re-

installation and curing.

3. The Contractor shall pull or invert the flexible tube through the existing sewer line in a method which has been reviewed and approved by the Construction Project Manager. The Contractor will not be allowed to use water to float the inserted flexible tube into the existing sewer line. Immediately after installation of the tube, a heat source will be applied to start the curing process. Constant pressure shall be maintained until the tube has completely cured out with continuous monitoring of the confined space during the curing procedure to ensure that the LEL is not exceeded.
4. The heat source shall be fitted with suitable monitors to gauge the temperature of the incoming and outgoing heat supply. Another such gauge shall be placed at the remote manhole to determine the temperature at that location during cure. The Contractor must maintain an on-site written log during the CIPP curing process for each installation, tracking temperature, pressure (for steam cure) and curing time. This log must be available for review at any time by the Construction Project Manager. If air pressure and steam are used, a Safety Gas Detector shall be used to ensure that it does not reach the explosive limit.
5. As noted within the submittals portion of this specification, before the installation process begins, the Contractor shall submit to the Construction Project Manager, the minimum pressure required to hold the tube tight against the existing conduit (including considerations for external ground water pressure, if present) and the maximum allowable pressure to avoid damaging the tube. This data shall be obtained by the Contractor from the tube manufacturer.

If the CIPP is installed via inversion, the pressure shall be maintained between the minimum and maximum pressures until the entire operation has been completed (inversion and cure). If the CIPP is installed using the pulled-in-place method, the pressures shall be maintained, after initial inflation, between the minimum and maximum pressures until the entire operation has been completed (inflation and cure).

If the pressure drops below the recommended minimum at any time during installation or curing of the CIPP, the liner should be removed and the host pipe re-inspected for dislodged pipe fragments or fallen debris which may cause bulging or protrusions within the cured CIPP. In addition, under the above circumstances, the CIPP product should be inspected for lifts or delaminations and evaluated for its ability to fully meet the applicable ASTM F1216 and F1743 requirements. Should the pressure deviate from within the range of minimum and maximum pressures, the installed tube may be rejected and the Contractor will be responsible for the removal of the CIPP without damage to the host pipe and replacement with new CIPP at no additional cost to the City.

Once the cure has started and dimpling for laterals is completed, the required pressures shall be sustained until the cure has been completed. A complete log of the pressures shall be maintained on the site and furnished to the Construction Project Manager after each installation.

6. The plastic coating of the tube shall be translucent to allow visual proof that the resin has wet out the entire tube and that there are no dry areas.
7. The Contractor shall maintain a log on site for each installation section documenting elongation, thickness and pulling force. These logs shall be submitted weekly to the Construction Project Manager.
8. The finished CIPP shall be continuous over the entire length of an installation run between two manholes and be free, as commercially practicable, from visual defects such as foreign inclusions, dry spots, pinholes, folds and delamination.
9. The Contractor shall apply Hydrophilic Seals at the upstream and downstream ends of all lined mains. The Contractor shall provide a submittal to the Construction Project Manager for approval on either a gasket or a non-cementitious (epoxy) grout.
10. Individual installation runs can be made over one or more manhole sections as determined in the field by the Contractor. The maximum allowed installation run is 1,200 feet. Intermediate manholes will be reopened as directed by the Construction Project Manager.

For UV-Cured Lining, CIPP installation shall be in accordance with Section 6 of ASTM F1743 for the Pulled-In- Place Installation Method, with the following requirements:

1. The inlet air hose shall be connected to the installation equipment and shall be equipped with an air compressor of sufficient capacity to expand the impregnated fabric tube. While the tube expands under pressure, a multi-lamp ultraviolet curing assembly shall be drawn through the pipe.
2. The ultraviolet curing lights shall be tuned or optimized to the photo initiator system of the resin, or the initiator systems of the resin shall be optimized to the output of ultraviolet curing lights.
3. Travel through the pipe shall be at a pre-determined speed which allows for cross-linking/polymerization of the CIPP resin. Air pressure shall be adjusted to sufficient pressure to hold the impregnated fabric tube tight to the pipe wall. The desired pressure shall be maintained by adjustment of the outlet valve.
4. A full protocol for time, rate of travel of the ultraviolet assembly, pressures, and the number of lamps in operation shall be maintained as documentation for the correct curing of the fabric tube. The protocol shall be recorded automatically from the beginning of inflation of the liner until the end of the curing. It shall also show the basic information in a header, such as project name, address, main (GIS Facility ID), and date, to clearly identify the renovated section.

The finished CIPP shall be continuous over the entire length of an installation and be free of dry spots, lifts, and delaminations. Where these conditions are present, the CIPP shall be evaluated for its ability to fully meet the applicable ASTM F1216 and F1743 requirements. The installed tube may be rejected, and the Contractor will be responsible for the removal of the CIPP without damage to the host pipe and replacement with new CIPP at no additional cost to the City.

### **10.7.7.7 Sewer Service Connection and Reactivation**

The Contractor shall determine if a service connection is active prior to rehabilitation of the sewer. Only active service connections and laterals shall be re-established. All costs incurred to verify active service connections are included within the “Cured-In-Place-Pipe” bid item within the contract. No additional payment for verification shall be considered.

After the curing of the CIPP has been completed, the Contractor shall reopen and restore the existing active service connections and branch connections. It is the intent of these Standard Construction Specifications that the active service connections and branch connections be reopened without excavation. When the pipe size is too small to facilitate direct manned reactivation, a remotely controlled cutting device, monitored by a close circuit television camera shall be used. The cutting device is required to re-establish service connections to not greater than 100% (one hundred percent) capacity, and not less than 95% (ninety five percent) capacity, while conforming to the shape of the existing opening. A smooth, or brushed, surface is required to prevent debris or solids from accumulating at the opening. Perforated services connections will be considered damaged and will need to be repaired. The Contractor shall be responsible for completing point repairs of any active service connections that are damaged or misaligned during reactivation procedures. These point repairs shall be completed as directed and approved by the Construction Project Manager and all costs shall be borne by the Contractor.

The Contractor shall certify he/she has a minimum of 2 (two) complete working cutting devices, plus spare key components on the site before each installation.

All solid or semi-solid material resulting from reactivation of the service connection or manhole cut outs shall be removed at the downstream manhole of the section being reactivated. Passing material from one manhole section to another shall not be permitted.

Service connections shall not remain out of service for more than 12 hours at a time, without the Contractor providing some means of temporary facilities or hotel accommodations for the affected residents or property owners.

### **10.7.8 Post Installation Inspection**

Post installation video inspection of all CIPP line segments shall be completed by the contractor and recorded using closed circuit television in accordance with ASTM F1216 or F1743. The post inspection of pipelines shall be performed in a manner which allows the invert to be clearly viewed and inspected (i.e. no water flow). The recorded video must show that all active service connections have been reactivated, the addresses served (both visible on the digital recording and audible), as well as any inclusions or visual defects present. All service connections and laterals which are not plugged or capped shall be re-established unless directed otherwise by the Construction Project Manager. The contractor shall review all post inspection videos and notify the City immediately of any visual defects, inclusions, or issues with the installation. Digital video records shall be submitted, as specified elsewhere in these standards.

## 10.7.9 Clean-Up

The Contractor shall reinstate all project areas affected by their operations to an equal or better condition than existing upon completion of the CIPP installation. All restoration must be completed prior to submitting that section of CIPP for consideration for payment.

## 10.7.10 Record Documentation

### 1. Digital Video and Log Sheets

The Contractor is required to provide pre- and post-video files, as well as associated log sheets, for all pipe segments rehabilitated under the contract. All video and log sheets must be submitted to the City and County of Denver. All digital video files shall be submitted in .mp4 format and log sheets shall be submitted in .pdf format. All files will be labeled in accordance with the instructions provided by the Construction Project Manager.

Pre- and post-inspection log sheets and digital video should be submitted together the week immediately following completion of each work segment, unless the contractor is submitting pre-inspection results separately to convey potential problem areas to the Construction Project Manager. Log sheets and digital video files not submitted at least 5 business days prior to a pay estimate cut-off date will not be considered for payment until the following month. It is the Contractor's responsibility to submit digital video media and log sheets in a timely fashion and as outlined in these specifications.

### 2. Redline Drawings

A final set of red-lined drawings shall be submitted by the Contractor on a clean, full size set of project plans for As-Built creation purposes prior to processing final payment and releasing remaining retainage. A .pdf copy of a clean set of project plans may be obtained from the Construction Project Manager upon request.

The red-lined drawings shall include the following: location and size of all pipe segments rehabilitated, the location of all restored service connections (showing distances from the downstream manhole), and the field recorded length of each rehabilitated segment (face of manhole to face of manhole). Providing inaccurate or incomplete record information is reason for withholding of progress payment as outlined in the General Contract Conditions.

## 10.7.11 Patents



The Contractor and the Contractor's suppliers shall warrant and save harmless the City against any and all claims, potential litigation involving patent infringement, copyright violations and any loss thereof.

**End of Specification**

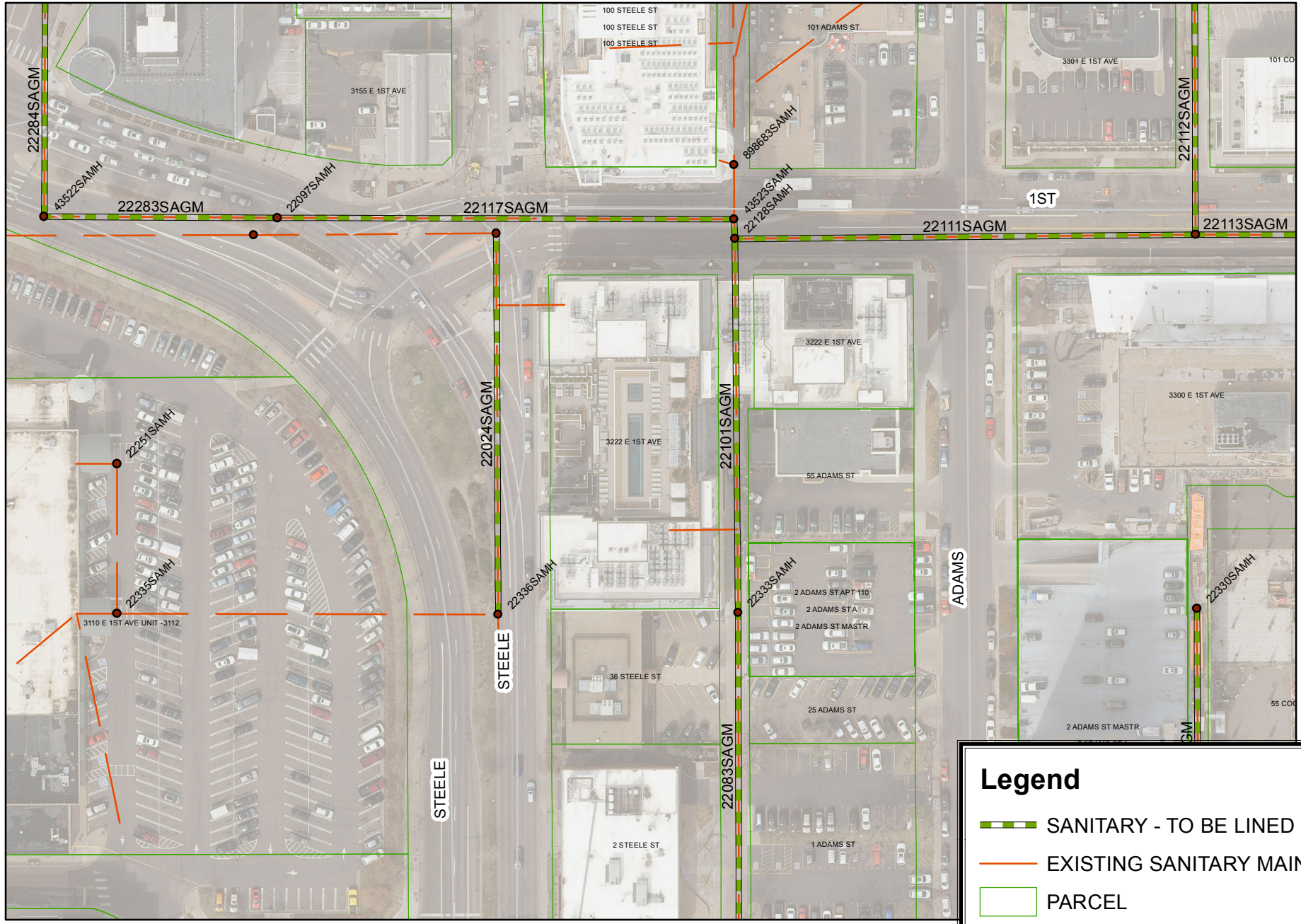
# CHERRY CREEK EAST SANITARY LINING - STEELE STREET AERIAL



**Legend**

-  SANITARY - TO BE LINED
-  EXISTING SANITARY MAIN
-  PARCEL

CITY AND COUNTY OF DENVER

STATE OF COLORADO



**DENVER**  
THE MILE HIGH CITY

DEPARTMENT OF PUBLIC WORKS

Prevailing Wage Rates

Contract Number: 201843656



General Sanitary – Cherry Creek Improvements

August 1, 2018





**DENVER**  
THE MILE HIGH CITY

**Office of Human Resources**

201 W. Colfax, Department 412

Denver, CO 80202

p: 720.913.5751

f: 720.913.5720

[www.denvergov.org/humanresources](http://www.denvergov.org/humanresources)

TO: All Users of the City of Denver Prevailing Wage Schedules

FROM: Susan Keller, Human Resources Technician, Classification & Compensation

DATE: Monday, July 16, 2018

SUBJECT: Latest Change to Prevailing Wage Schedules

Please be advised, prevailing wage rates for some building, heavy, highway, and residential construction trades have not been updated by the United States Department of Labor (DOL) since March 1, 2002. The Career Service Board, in their meeting held on April 21, 2011, approved the use of the attached supplemental wage rates until prevailing wage rates for these classifications of work are again published by the United States Department of Labor in accordance with the Davis-Bacon Act.

The effective date for this publication will be **Friday, July 13, 2018** and applies to the City and County of Denver for **HEAVY CONSTRUCTION PROJECTS** in accordance with the Denver Revised Municipal Code, Section 20-76(c).

General Wage Decision No. CO180012  
Superseded General Decision No. CO20170012  
Modification No. 5  
Publication Date: 07/13/2018  
(5 pages)

Unless otherwise specified in this document, apprentices shall be permitted only if they are employed pursuant to, and individually registered in, a bona fide apprenticeship program registered with the U.S. Department of Labor (DOL). The employer and the individual apprentice must be registered in a program, which has received prior approval, by the DOL. Any employer, who employs an apprentice and is found to be in violation of this provision, shall be required to pay said apprentice the full journeyman scale.

Attachments as listed above.

General Decision Number: CO180012 07/13/2018 CO12

Superseded General Decision Number: CO20170012

State: Colorado

Construction Type: Heavy

Counties: Adams, Arapahoe, Boulder, Broomfield, Denver, Douglas, El Paso, Jefferson, Larimer, Mesa, Pueblo and Weld Counties in Colorado.

HEAVY CONSTRUCTION PROJECTS

Note: Under Executive Order (EO) 13658, an hourly minimum wage of \$10.35 for calendar year 2018 applies to all contracts subject to the Davis-Bacon Act for which the contract is awarded (and any solicitation was issued) on or after January 1, 2015. If this contract is covered by the EO, the contractor must pay all workers in any classification listed on this wage determination at least \$10.35 per hour (or the applicable wage rate listed on this wage determination, if it is higher) for all hours spent performing on the contract in calendar year 2018. The EO minimum wage rate will be adjusted annually. Please note that this EO applies to the above-mentioned types of contracts entered into by the federal government that are subject to the Davis-Bacon Act itself, but it does not apply to contracts subject only to the Davis-Bacon Related Acts, including those set forth at 29 CFR 5.1(a)(2)-(60). Additional information on contractor requirements and worker protections under the EO is available at www.dol.gov/whd/govcontracts.

Modification Number	Publication Date
0	01/05/2018
1	01/12/2018
2	02/02/2018
3	02/09/2018
4	03/02/2018
5	07/13/2018

ASBE0028-001 07/01/2017

	Rates	Fringes
Asbestos Workers/Insulator (Includes application of all insulating materials, protective coverings, coatings and finishings to all types of mechanical systems).....	\$ 30.73	14.23

\* BRCO0007-004 01/01/2018

ADAMS, ARAPAHOE, BOULDER, BROOMFIELD, DENVER, DOUGLAS, JEFFERSON AND WELD COUNTIES

	Rates	Fringes
BRICKLAYER.....	\$ 27.98	10.04

-----  
\* BRCO0007-006 05/01/2018

EL PASO AND PUEBLO COUNTIES

	Rates	Fringes
BRICKLAYER.....	\$ 25.88	10.34

-----

ELEC0012-004 01/01/2018

PUEBLO COUNTY

	Rates	Fringes
ELECTRICIAN		
Electrical contract over		
\$1,000,000.....	\$ 27.95	11.40+3%
Electrical contract under		
\$1,000,000.....	\$ 24.85	11.40+3%

-----

\* ELEC0068-001 06/01/2018

ADAMS, ARAPAHOE, BOULDER, BROOMFIELD, DENVER, DOUGLAS,  
JEFFERSON, LARIMER, AND WELD COUNTIES

	Rates	Fringes
ELECTRICIAN.....	\$ 35.80	15.45

-----

ELEC0111-001 09/01/2017

	Rates	Fringes
Line Construction:		
Groundman.....	\$ 25.68	25.25%+\$5.75
Line Equipment Operator.....	\$ 31.35	25.25% + \$5.75
Lineman and Welder.....	\$ 44.92	25.25%+\$5.75

-----

\* ELEC0113-002 06/01/2018

EL PASO COUNTY

	Rates	Fringes
ELECTRICIAN.....	\$ 31.80	15.90

-----

ELEC0969-002 06/01/2015

MESA COUNTY

	Rates	Fringes
ELECTRICIAN.....	\$ 24.00	7.92

-----

ENGI0009-001 05/01/2017

	Rates	Fringes
Power equipment operators:		
Blade: Finish.....	\$ 27.92	10.10
Blade: Rough.....	\$ 27.60	10.10

Bulldozer.....	\$ 27.60	10.10
Cranes: 50 tons and under..	\$ 27.75	10.10
Cranes: 51 to 90 tons.....	\$ 27.92	10.10
Cranes: 91 to 140 tons.....	\$ 28.55	10.10
Cranes: 141 tons and over...	\$ 29.82	10.10
Forklift.....	\$ 27.22	10.10
Mechanic.....	\$ 28.08	10.10
Oiler.....	\$ 26.84	10.10
Scraper: Single bowl under 40 cubic yards.....	\$ 27.75	10.10
Scraper: Single bowl, including pups 40 cubic yards and over and tandem bowls.....	\$ 27.92	10.10
Trackhoe.....	\$ 27.75	10.10

-----  
IRON0024-003 11/01/2017

	Rates	Fringes
Ironworkers:.....	\$ 27.45	27.76
Structural		

-----  
LABO0086-001 05/01/2009

	Rates	Fringes
Laborers: Pipelayer.....	\$ 18.68	6.78

-----  
PLUM0003-005 06/01/2017

ADAMS, ARAPAHOE, BOULDER, BROOMFIELD, DENVER, DOUGLAS,  
JEFFERSON, LARIMER AND WELD COUNTIES

	Rates	Fringes
PLUMBER.....	\$ 39.08	16.44

-----  
\* PLUM0058-002 07/01/2018

EL PASO COUNTY

	Rates	Fringes
Plumbers and Pipefitters.....	\$ 37.25	14.85

-----  
\* PLUM0058-008 07/01/2018

PUEBLO COUNTY

	Rates	Fringes
Plumbers and Pipefitters.....	\$ 37.25	14.85

-----  
PLUM0145-002 07/01/2016

MESA COUNTY

	Rates	Fringes
Plumbers and Pipefitters.....	\$ 35.17	11.70

-----  
PLUM0208-004 06/01/2016

ADAMS, ARAPAHOE, BOULDER, BROOMFIELD, DENVER, DOUGLAS,  
JEFFERSON, LARIMER AND WELD COUNTIES

	Rates	Fringes
PIPEFITTER.....	\$ 37.10	16.62

-----  
SHEE0009-002 07/01/2017

	Rates	Fringes
Sheet metal worker.....	\$ 33.26	16.61

-----  
TEAM0455-002 07/01/2017

	Rates	Fringes
Truck drivers:		
Pickup.....	\$ 20.91	4.22
Tandem/Semi and Water.....	\$ 21.54	4.22

-----  
SUCO2001-006 12/20/2001

	Rates	Fringes
BOILERMAKER.....	\$ 17.60	
Carpenters:		
Form Building and Setting...	\$ 16.97	2.74
All Other Work.....	\$ 15.14	3.37
Cement Mason/Concrete Finisher...	\$ 17.31	2.85
IRONWORKER, REINFORCING.....	\$ 18.83	3.90
Laborers:		
Common.....	\$ 11.22	2.92
Flagger.....	\$ 8.91	3.80
Landscape.....	\$ 12.56	3.21
Painters:		
Brush, Roller & Spray.....	\$ 15.81	3.26
Power equipment operators:		
Backhoe.....	\$ 16.36	2.48
Front End Loader.....	\$ 17.24	3.23
Skid Loader.....	\$ 15.37	4.41

-----  
WELDERS - Receive rate prescribed for craft performing  
operation to which welding is incidental.

**Office of Human Resources**  
**Supplemental rates**  
**(Specific to the Denver Projects)**  
**(Supp #74, Date: 02-03-2012)**

<b>Classification</b>		<b>Base</b>	<b>Fringe</b>
Ironworker	Ornamental	\$24.80	\$10.03
Laborer	Group 1	\$18.18	\$8.27
	Group 2	\$21.59	\$8.61
Laborer (Janitor)	Janitor/Yardmen	\$17.68	\$8.22
Laborer (Asbestos)	Removal of Asbestos	\$21.03	\$8.55
Laborer (Tunnel)	Group 1	\$18.53	\$8.30
	Group 2	\$18.63	\$8.31
	Group 3	\$19.73	\$8.42
	Group 4	\$21.59	\$8.61
	Group 5	\$19.68	\$8.42
Line Construction	Lineman, Gas Fitter/Welder	\$36.88	\$9.55
	Line Eq Operator/Line Truck Crew	\$25.74	\$8.09
Millwright		\$28.00	\$10.00
Power Equipment Operator	Group 1	\$22.97	\$10.60
	Group 2	\$23.32	\$10.63
	Group 3	\$23.67	\$10.67
	Group 4	\$23.82	\$10.68
	Group 5	\$23.97	\$10.70
	Group 6	\$24.12	\$10.71
	Group 7	\$24.88	\$10.79
Power Equipment Operator (Tunnels above and below ground, shafts and raises):	Group 1	\$25.12	\$10.81
	Group 2	\$25.47	\$10.85
	Group 3	\$25.57	\$10.86
	Group 4	\$25.82	\$10.88
	Group 5	\$25.97	\$10.90
	Group 6	\$26.12	\$10.91
	Group 7	\$26.37	\$10.94
Truck Driver	Group 1	\$18.42	\$10.00
	Group 2	\$19.14	\$10.07
	Group 3	\$19.48	\$10.11
	Group 4	\$20.01	\$10.16
	Group 5	\$20.66	\$10.23
	Group 6	\$21.46	\$10.31

Go to <http://www.denvergov.org/Auditor> to view the Prevailing Wage Clarification Document for a list of complete classifications used.

CITY AND COUNTY OF DENVER

STATE OF COLORADO



**DENVER**  
THE MILE HIGH CITY

DEPARTMENT OF PUBLIC WORKS

Technical Specifications

Contract Number: 201843656



General Sanitary – Cherry Creek Improvements

August 1, 2018

CITY AND COUNTY OF DENVER

STATE OF COLORADO



**DENVER**  
THE MILE HIGH CITY

DEPARTMENT OF PUBLIC WORKS

Technical Specifications

Contract Number: 201843656



General Sanitary – Cherry Creek Improvements

August 1, 2018





CITY AND COUNTY OF DENVER  
ENGINEERING DIVISION

## Wastewater Capital Projects Management Project Specific Construction Specification

**Bid Item 01-55.26.01 UNIFORMED TRAFFIC CONTROL/JOBSITE SECURITY(HOURLY)**

### **ALLOWANCE ACCOUNT**

**GENERAL SANITARY - CHERRY CREEK IMPROVEMENTS  
ALLOWANCE ACCOUNT ITEMS**

#### **DESCRIPTION**

This Special Provision contains the City and County of Denver's estimate for Allowance Account Items for **all allowances** necessary for the **hourly Uniformed Traffic Control/Jobsite Security**. Duties of the Uniform Traffic Control shall be performing Traffic Control in accordance with the MUTCD or Jobsite Security in accordance with the City and County of Denver Executive Orders, Policies, Procedures, Ordinances, and the guidelines established by the Denver Police Department Office of Secondary Employment. All duties shall be coordinated by the Contractor with acceptance/concurrence of the City and County of Denver Construction Project Manager.

Allowance Account work shall be performed by City and County Police Officers through the City and County of Denver Office of Secondary Employment. The City and County of Denver Police Department Office of Secondary Employment may require a contract. The contractor must submit a finalized, accepted contract to the City Construction Project Manager within 60 days of Notice to Apparent Low Bidder. All work requests for Uniformed Traffic Control or Job Site Security shall be submitted to the City and County of Denver Police Department Office of Secondary Employment at least 14 days in advance. The contractor must show on their critical path schedule, submitted to the City Construction Project Manager and to the City and County of Denver Police Department Office of Secondary Employment, all information regarding days of the week and hours of the day when and where uniformed traffic control or job site security are requested. The contractor's failure to provide advanced notice and to the City and County of Denver Police Department Office of Secondary Employment may result in either a scheduling conflict or billing adjustment to the hourly pricing. The City Construction Project Manager will not approve charges greater than \$75.00 per hour for work which has not been scheduled at least 14 days in advance. All costs associated for Uniformed Traffic Control/Jobsite Security shall be reviewed and reimbursed to the contractor as approved by the City Construction Project Manager. In no event shall reimbursement to the contractor exceed that maximum total indicated in the basis of payment below.



CITY AND COUNTY OF DENVER  
ENGINEERING DIVISION

## Wastewater Capital Projects Management Project Specific Construction Specification

### BASIS OF PAYMENT

Payment will be made at unit prices for a schedule of values associated with each allowance account item category indicated below as **(A)** the total estimated hourly employment costs of the Uniformed Traffic Control and **(B)** the total estimated hourly employment costs of the Jobsite Security. The schedule of values and a signed contract (when required) shall be submitted by the contractor and accepted by the City Construction Project Manager within 60 days of Notice to Apparent Low Bidder. Uniformed Traffic Control and Jobsite Security personnel shall be Denver Police Department Employees. The unit prices will only be paid at true and verifiable cost plus a 3% mark up in accordance with the City and County of Denver General Contract Conditions. Mark up shall not be applied to sales tax or any other fees/charges. Payment will constitute full compensation for all true and verifiable costs associated with Uniformed Traffic Control and Jobsite Security to complete the scope of the project. The contractor will be required to submit itemized invoices for hourly employment of Uniformed Traffic Control and Jobsite Security; along with a spreadsheet tabulation indicating the 3% for inclusion in the Field Measurement Report (FMR). The City Construction Project Manager will approve payments in the appropriate dollar amount on the monthly payment applications.

No payment will be made under this bid item for any items associated with bid item 41-1 **Traffic Control**, 16-1 **Security Fence**, or 2-16.4 **Remove Security Fence**.

Allowance Account work must be coordinated through the City and County of Denver Police Department's Office of Secondary Employment\*\* and shall only be paid for after receipt of an itemized statement endorsed by the Contractor and approved by the City Construction Project Manager.

<b>Item No.</b>	<b>Allowance Account Item</b>	<b>Quantity</b>	<b>Estimated Amount</b>
<b>01-55.26.01A</b>	Uniformed Traffic Control	A/A	\$6,000
<b>01-55.26.01B</b>	Jobsite Security	A/A	N/A
<b>Maximum Total:</b>			<b>\$6,000</b>



CITY AND COUNTY OF DENVER  
ENGINEERING DIVISION

## Wastewater Capital Projects Management Project Specific Construction Specification

### Allowance Account Item Definitions:

**01-55.26.01A** **Uniformed Traffic Control** – The price shall include all the Contractor’s costs of whatsoever nature, incurred in contracting with Denver Police Department Office of Secondary Employment\*\*. The price shall include: all labor required for the Police Officer(s) to provide Uniformed Traffic Control as required by Traffic Control Plan and/or the Street Occupancy Permits; as approved by the City Construction Project Manager.

**01-55.26.01B** **Job Site Security** – The price shall include all the Contractor’s costs of whatsoever nature, incurred in contracting with Denver Police Department Office of Secondary Employment\*\*. The price shall include: all labor required for the Police Officer(s) to provide Job Site Security as approved\* by the City Construction Project Manager.

\*\*Contact for the Denver Police Department Office of Secondary Employment – Analisa Ortiz  
([Analisa.Ortiz@denvergov.org](mailto:Analisa.Ortiz@denvergov.org)) 720-377-0775



CITY AND COUNTY OF DENVER  
ENGINEERING DIVISION

## **Wastewater Capital Projects Management Project Specific Construction Specification**

Date Issued 07/31/2018



CITY AND COUNTY OF DENVER  
ENGINEERING DIVISION

**Wastewater Capital Projects Management  
Standard Construction Specifications**

**Measurement and Payment**

March 15, 2016

# Measurement and Payment

---

## **01-5213 Temporary Office Facilities**

No quantity measurement will be made for any of the work and materials required to accomplish this aspect of the project and payment will be based upon the percentage of this work item completed in accordance with the plans and specifications and as approved by the City Construction Project Manager.

*This item includes: furnishing, installing, maintaining, cleaning, periodic inspections, adjustments and modifications, and removal of all temporary office facilities; providing utilities and services including but not limited to the following: water, electric, telephone, DSL hard line, acceptable scanner, copy machine, printer, internet, sanitary facilities, security measures, storage areas, etc. and payment of associated monthly bills during project duration; development and maintenance of access and haul routes, furnishing and installation of temporary construction fencing; securing temporary facility location, securing of required permits, payment of all associated fees, restoring the site to a better or equal condition than prior to use, and all other equipment and labor required for the implementation, maintenance and removal of all temporary office facilities.*

*At the option of the Construction Project Manager, one quarter of the lump sum price for temporary office facilities may be paid to the Contractor at the time of the first monthly progress payment, the second quarter may be paid at the time of the second monthly progress payment, and the third quarter may be paid to the Contractor at the time of the third monthly progress payment, or at the discretion of the Construction Project Manager. The total payment for this bid item shall not exceed seventy-five percent (75%) of the lump sum price during construction. The remaining twenty-five percent (25%) shall be paid after all facilities have been completely removed and the location of said facilities has been returned to an equal or better condition than prior to use by the Contractor.*

---

## **02-2213 Vibration Assessment**

No quantity measurement will be made for any of the work and materials required to accomplish this aspect of the project and payment will be based upon the completion of the work in accordance with the Contract Documents.

*The lump sum price for Vibration Assessment shall include all of the Contractor's costs of whatsoever nature. The price bid shall include: all labor, equipment, materials, subcontractors, and transportation to and from project site required to complete vibration monitoring and assessment during the entire project duration regardless of extensions; furnishing submittals, baseline and monthly reports; theft and vandalism protection; web based data access and site training; incidentals; meetings and coordination with business owners and residents as necessary during construction; and all other related and necessary materials work and equipment required to accomplish this item in accordance with the Contract Documents.*

*At the option of the Construction Project Manager, one third of the lump sum price for this item may be paid to the Contractor upon satisfactory completion of and/or incorporation of proper measures. The second third may be paid upon fifty percent completion of the work as determined by the percent of work completed on the day of progress payment. The last third may be paid to the Contractor at the time of final progress payment or at the discretion of the Construction Project Manager.*

# Measurement and Payment

---

## 02\_8216.10 Certified Asbestos Inspector (CABI)/Air Monitor

No quantity measurement will be made for any of the work and materials required to accomplish this aspect of the construction and payment will be based upon completion of the work in accordance with the Contract Documents. The lump sum price bid shall include the coordination and performance of an onsite CABI and air monitoring.

*The lump sum price for the CABI/air monitor shall include all of the Contractor's costs of whatsoever nature, including licensing and certification of the CABI. The price bid shall include: all labor, materials and equipment required for the inspector to monitor the construction site, evaluate potential asbestos containing material, and collect air fiber samples; lab testing as required; and all other related and necessary materials, work, and equipment required for completion of this work in accordance with the Contract Documents. Duties of the CABI/Air monitor shall be to monitor and cause to enforce that all project activities, excavations, and site controls are in compliance with Denver Environmental Health – Asbestos-Contaminated Soil Management Standard Operating Procedure (current version); all state and federal laws and regulations and guidelines; provide asbestos awareness training for all personnel associated with the project; and any other duties as defined within a site specific Material Management Plan.*

*At the option of the Construction Project Manager, monthly percentage payments, based upon Period of Performance, may be paid to the contractor upon satisfactory completion of and/or proper controls submitted in monthly payment application, or at the discretion of the Construction Project Manager. Up to the last progress payment or at the discretion of the Construction Project Manager.*

---

## 31-3223.12 Soil Improvement by Compaction Grouting

The measurement for payment of this item will be the total number of vertical lineal feet of soil improvement by compaction grouting as measured between bedrock (or depth of refusal) and the subgrade of the proposed facility to be supported (treated area).

Measurement will be based on the total vertical linear feet that the grout injection rod advances from the existing ground surface to bedrock or refusal less the plan depth at the grout port location (as shown on the plans) for rod advancement measured from ground surface to subgrade of the facility to be supported (untreated area). Drilling logs showing actual vertical lineal footages of rod advancement depth through the untreated area and into the treated area shall be provided by the contractor as basis for payment of this item.

Payment will be made based upon documented drilling logs showing the vertical linear feet of complete, in place, in a manner satisfactory to the Construction Project Manager, provided, however no payment will be made for compaction grouting due to negligence or unauthorized operations by the Contractor.

*The unit price bid per vertical linear foot of compaction grouting within the treated zone shall include all of the Contractor's costs of whatsoever nature. The price bid shall include: all labor, equipment, materials, grout, testing ground/structure monitoring system, installation and removal of grout pipes, furnish and injection of compaction grout, monitoring of ground/structure movements; survey, following the grouting sequence of operations as set forth in the contract documents, monitoring of all vertical measurements, all revisions of work*

# Measurement and Payment

*plans and retesting to establish if grouting meets the contract requirements; hauling and disposal of construction debris, unsuitable material and contaminated materials at the Denver Arapahoe Disposal Site (DADS); in accordance with all specifications included within the contract documents. The Contractor shall be responsible for obtaining all permits, field verification of all utilities*

---

## **31-3223.12a Overburden Penetration for Compaction Grouting**

The measurement for payment of this item will be the total number of vertical linear feet of overburden penetration during soil improvement by compaction grouting as measured between the existing ground surface to the subgrade of the proposed facility to be supported (untreated area). Measurement will be based on vertical linear feet (plan depth) at the grout port location (as shown on the plans) for rod advancement measured from ground surface to subgrade of the facility to be supported (untreated area). Drilling logs showing actual vertical lineal footages of rod advancement depth through the untreated area and into the treated area shall be provided by the contractor as basis for payment of this item.

Payment will only be made based upon the plan depth of overburden penetration measured in vertical linear feet and as documented in drilling logs showing the vertical linear feet of overburden penetration, where successful grout placement has occurred, and as in a manner satisfactory to the Construction Project Manager, provided, however no payment will be made for overburden penetration due to negligence or unauthorized operations by the Contractor.

*The unit price bid per linear foot of overburden penetration for compaction grouting shall include all of the Contractor's costs of whatsoever nature. The price bid shall include: steel casing pipe and all labor, equipment, materials and all other related and necessary items, complete in accordance with the Contract Documents.*

---

- 2-1.1a Remove Combination Concrete Curb, Gutter and Sidewalk (2'8")**
- 2-1.1b Remove Combination Concrete Curb, Gutter and Sidewalk (3'11")**
- 2-1.2a Remove 6" Concrete Curb and/or Gutter**
- 2-1.2b Remove 9" Concrete Curb and/or Gutter**
- 2-1.3 Remove Concrete Curb Head**
- 2-1.4 Remove Handicap Concrete Curb Ramp**
- 2-1.5 Remove Concrete Median Strip**
- 2-2.1 Remove Concrete Sidewalk**
- 2-2.1a Remove Concrete Sidewalk/Bike Path**
- 2-2.2 Remove Concrete Driveway Paving**
- 2-2.4 Remove Concrete Channel Paving**
- 2-2.5 Remove Miscellaneous Concrete Flatwork**

The measurement for payment of this item will be the total number of linear feet or square feet of existing concrete curb and gutter, combination concrete curb and gutter, concrete curb head, concrete handicap curb ramp, concrete median strip, concrete sidewalk, concrete bike path, concrete driveway pavement, concrete slab, concrete alley return, concrete alley paving, concrete channel paving or any other type of miscellaneous concrete flatwork as specified in the Contract Documents or designated by the Construction Project Manager to be removed for construction of the proposed sewer and/or appurtenances; provided, however, no



## Measurement and Payment

measurement for payment will be made for concrete flatwork removed or damaged due to negligence or unauthorized operations by the Contractor.

*The unit price bid per linear foot or square foot removal of this item shall include all of the Contractor's costs of whatsoever nature. The price bid shall include: excavation, concrete sawing or otherwise effectively cutting the concrete item smoothly and squarely in a manner satisfactory to the Construction Project Manager; excavation and overexcavation; removal and disposal of unsuitable material, existing flatwork and/or any reinforcing materials per the requirements set forth in the Contract Documents; and all other related and necessary materials, work, and equipment required to remove this item in accordance with the Contract Documents.*

---

### **2-2.6 Remove and Replace Flagstone Curb Head**

#### **2-2.7 Remove and Replace Flagstone Walk**

The measurement for payment of this item will be the total number of linear feet of Flagstone Curb Head or the total square feet of flagstone walk required to be removed or placed for construction of the proposed sewer and/or appurtenances; provided, however, no measurement for payment will be made for flagstone removed and replaced due to negligent or unauthorized operations by the Contractor.

*The unit price bid per linear foot or square foot removal and replacement of this item shall include all of the Contractor's costs of whatsoever nature. The price bid shall include: excavation, sawing or otherwise effectively cutting the flagstone item smoothly and squarely in a manner satisfactory to the Construction Project Manager; excavation and over excavation; removal and disposal of unsuitable material; storing on site for reuse; placement and/or replacement of flagstone; furnishing of new flagstone or equivalent stone as necessary; cutting, shaping, leveling, grouting, spacing; bedding, supply and placement of select subgrade material or select fill as necessary, compaction, and all other related and necessary materials, work, and equipment required to remove and replace this item in accordance with the Contract Documents.*

---

### **2-2.8 Remove Asphalt Walk**

The measurement and payment of this item will be the total number of linear feet of asphalt walk required to be removed, and/or removed and replaced for the proposed sewer and/or appurtenances; provided, however, no measurement for payment will be made for asphalt walk removal or replacement required due to negligent or unauthorized operations by the Contractor.

*The unit price bid per linear foot removal, removal and replacement, or placement of this item shall include all of the Contractor's costs of whatsoever nature. The price bid shall include: excavation, grading and shaping; placement of bedding; excavation and overexcavation; removal and disposal of unsuitable material; placement and/or replacement; furnishing of asphalt; leveling and compaction, and all other related and necessary materials, work, and equipment required to remove this item in accordance with the Contract Documents.*

---

### **2-3 Remove Concrete Wheel Stops**

The measurement for payment of this item will be the total number existing wheel stops required to be removed or placed for construction of the proposed sewer and/or appurtenances; provided, however, no measurement for payment will be made for wheel stops removed and replaced due to negligent or unauthorized operations by the Contractor.

---

# Measurement and Payment

*The unit price bid per wheel stop removal shall include all of the Contractor's costs of whatsoever nature. The price bid shall include: excavation, sawing or otherwise effectively removing the wheel stop in a manner satisfactory to the Construction Project Manager; excavation and overexcavation; removal and disposal of unsuitable material; storing on site for reuse; placement of replacement; furnishing of new wheel stops; cutting, leveling, grouting, spacing; bedding, compaction, and all other related and necessary materials, work, and equipment required to remove this item in accordance with the Contract Documents.*

---

**2-3.1 Remove Concrete Alley Gutter**

**2-3.2 Remove Concrete Alley Returns**

**2-3.3 Remove Concrete Alley Paving**

**2-3.4 Remove Concrete Street Intersection Gutter (Crossspan) and/Or Valley Gutter**

**2-3.5 Remove Concrete Street Paving**

The measurement for payment of this item will be the total number of square feet of concrete required to be removed for construction of the proposed sewer; provided, however, no payment will be made for damaged material required to be removed due to negligence or unauthorized operations by the Contractor or any Subcontractors.

*The unit price bid per square foot for removing this item shall include all of the Contractor's costs of whatsoever nature. The price bid shall include: concrete sawing and otherwise effectively cutting the existing concrete smoothly and squarely in a manner satisfactory to the Construction Project Manager; removal and disposal of concrete, asphalt, and/or any reinforcing materials, including removal of the square radius beyond the lip of the standard two-foot gutter; furnishing additional base material; subgrade preparation and compaction; rotomilling within the effective removal limits; and all other related and necessary materials, work, and equipment required to accomplish the removal of this item in accordance with the Contract Documents.*

*In addition to the above listed items, the unit price bid per square foot removal of concrete street intersection gutter and/or valley gutter shall include repaving of the street within the effective removal limits to a point not less than 2-inches below the new finished street grade (matching cross street crowns to within 2-inches of finished street grade to the satisfaction of the Construction Project Manager), including surrounding areas damaged during removal. The effective removal limits encompass the surface area shown on the Project Paving Schematic included within the Contract Documents. This area varies based on location within the project. The additional 2-inches of paving within the effective removal limits, as well as all required rotomilling and asphalt placement outside the limits will be paid for using bid items*

*provided for elsewhere in the Contract Documents. No separate measurement or payment will be made for additional paving materials or rotomilling necessary for adherence to this item, all such costs will be included in the square foot price for removal.*

---

**2-4 Remove Concrete Steps**

The measurement for payment of this item will be the total number of square feet of concrete steps required to be removed for construction of the proposed sewer and/or appurtenances; provided, however, no measurement for payment will be made for concrete steps removed and replaced due to negligent or unauthorized operations by the Contractor.

*The unit price bid per square foot of concrete steps, which shall be quantified by the width of the stairs multiplied by the summation of each stair hypotenuse (the hypotenuse of the rise and run of each stair). The unit price shall include all of the Contractor's costs of whatsoever nature.*

---

# Measurement and Payment

*The price bid shall include: excavation, sawing or otherwise effectively removing the steps in a manner satisfactory to the Construction Project Manager; excavation and overexcavation; removal of any foundation concrete; removal and disposal of unsuitable material; backfilling of foundation with suitable bedding, compaction, and all other related and necessary materials, work, and equipment required to remove this item in accordance with the Contract Documents.*

---

## **2-5 Remove Concrete Retaining Wall**

The measurement for payment of this item will be the total number of linear feet of retaining wall, including attached railing and/or fence required to be removed for construction of the proposed sewer and/or appurtenances; provided, however, no measurement for payment will be made for retaining wall removal required due to negligent or unauthorized operations by the Contractor.

*The unit price bid per linear foot of retaining wall removal shall include all of the Contractor's costs of whatsoever nature. The price bid shall include: excavation, sawing or otherwise effectively removing the wall in a manner satisfactory to the Construction Project Manager; excavation and overexcavation; removal of any foundation concrete; removal of tie backs, drainage pipe; removal and disposal of fence and/or railings; removal and disposal of unsuitable material; removal of brick, wood, cinder block, steel sheeting, or rock walls; backfilling of foundation with suitable bedding, compaction, and all other related and necessary materials, work, and equipment required to remove this item in accordance with the Contract Documents.*

---

## **2-6 Remove Concrete Headwall**

No partial measurement for payment will be made for this item, removal and payment will be based upon complete removal of the concrete headwall and/or attached railing and/or fence to the satisfaction of the Construction Project Manager or to the requirements of the Contract Documents; provided, however, no measurement for payment will be made for retaining wall removal required due to negligent or unauthorized operations by the Contractor.

*The unit price bid per lump sum concrete headwall removal shall include all of the Contractor's costs of whatsoever nature. The price bid shall include: effectively removing the wall in a manner satisfactory to the Construction Project Manager; excavation and overexcavation; removal of any foundation concrete; removal of tie backs, drainage pipe; removal and disposal of unsuitable material; removal of brick, wood, cinder block, steel sheeting, or rock headwalls; removal and disposal of fence and/or railings; backfilling of foundation with suitable bedding, compaction, and all other related and necessary materials, work, and equipment required to remove this item in accordance with the Contract Documents.*

---

## **2-11 Remove or Abandon Existing Pipe and Box Culverts**

### **8-4 Remove Existing Waterline**

The measurement and payment for this item will be the total number of linear feet of existing pipe, flared end sections, box culvert, and/or waterline of the dimensions specified, required to be removed or abandoned for construction of the proposed sewer and/or appurtenances; however, no payment will be made for pipe removed or abandoned due to negligence or unauthorized operations by the Contractor.

*The unit price bid per linear foot of removal or abandonment shall include all of the Contractor's costs of whatsoever nature. The price bid shall include: excavation; care and diversion of drainage courses; removal of pipe, cone sections and sewer appurtenances as necessary to*

---

## Measurement and Payment

*complete the removal or abandonment as specified in the Contract Documents including removal and disposal of the existing conduit and appurtenances (per State and Local requirements where applicable for lines containing asbestos); hauling and disposal of construction debris, unsuitable material and contaminated materials at the Denver Arapahoe Disposal Site (DADS); removal of pavement, sod and other surfacing materials; excavation, including exploratory excavation; diversion, cutting and plugging of pipe, as necessary, per the Contract Documents, any additional labor, equipment and materials required to disconnect the existing facility as required by the owner, salvaging of pipe when directed by the Construction Project Manager or when specified in the Contract Documents, placing of the salvaged pipe on the job site in a location designated by the Construction Project Manager; reforming and reshaping of manhole inverts as required; backfilling to final grade with approved backfill material; filling of abandoned pipe with an approved CLSM or alternately approved product, per the requirements set forth in the Standard Construction Specifications; compaction of materials as necessary; paving, curb, gutter, sidewalk, landscaping and any other surface restoration required due to removal of associated items; coordination with utility owner as required and all other related and necessary materials, work, and equipment required to complete removal or abandonment in accordance with the Contract Documents.*

---

### **2-11.8 Remove Abandoned Steam Pipe With Asbestos Lining (<24" Diameter)**

The measurement for payment of this item will be the total number of linear feet of pipe required to be removed and transported to an approved disposal site for construction of the proposed sewer; provided, however, no payment will be made for removal due to negligence or unauthorized operations by the Contractor or any Subcontractors.

The removal of abandoned steam pipe with asbestos lining shall comply with Colorado State Regulation No. 8, Part B, which incorporates the Environmental Protection Agency (EPA) National Emissions Standards for Hazardous Air Pollutants (NESHAP) Regulations for Asbestos (40 CFR Part 61). More specifically, the removal activity must comply with § III.S.4. (Other Non-friable Asbestos-Containing Materials) and if at a quantity above trigger levels (§I.B.104) are also subject to § III.E. (State Notifications) of the stated regulation. If during abatement, the asbestos cement product becomes friable, the project activity shall meet and conform with all the requirements in sections I (Definitions), II (Certification Requirements), and III (Abatement, Renovation and Demolition Projects) of the stated regulation. All abatement projects involving asbestos products are subject to Occupation Safety and Health Administration (OSHA) Standards for Asbestos (29 CFR Parts 1910.1001 and 1926.1101). Transportation of asbestos-containing waste materials is regulated by the Colorado Department of Transportation (CDOT). All expenses incurred to comply with the above noted items shall be borne by the Contractor.

*The unit price bid per linear foot for removal shall include all of the Contractor's costs of whatsoever nature. The price bid shall include: excavation; care and diversion of drainage courses; removal of pipe, insulating materials and appurtenances; removal of pavement, sod, and other surfacing materials; excavation, including exploratory excavation; coordination and interaction with abandoned facility owner to ensure that a chain of custody is maintained; hauling and disposal of construction debris, excess excavated material, damaged materials and asbestos contaminated materials at the Denver Arapahoe Disposal Site (DADS) unless otherwise specified or required by State regulations; backfilling and compaction to final grade with an approved backfill material; and all other related and necessary materials, work and equipment required to remove the existing abandoned steam pipe with asbestos lining in accordance with the Contract Documents.*

# Measurement and Payment

---

- 2-12.1 Remove Existing Sanitary Manhole**
- 2-12.2 Remove Existing Storm Manhole**
- 2-12.3 Abandon Existing Sanitary Manhole**
- 2-12.4 Abandon Existing Storm Manhole**
- 2-12.7 Remove Existing Structure**
- 2-13.1 Remove Existing Storm Inlet**
- 2-13.2 Remove Existing Special Storm Inlet**

The measurement for payment of this item will be the total number of manholes, inlets or structures required to be removed or abandoned for construction of the proposed sewer and/or appurtenances; however, no payment will be made for structures removed due to negligence or unauthorized operations by the Contractor.

*The unit price bid per manhole, inlet or structure removal and/or abandonment shall include all of the Contractor's costs of whatsoever nature. The price bid shall include: excavation, overexcavation, exploratory excavation; care and diversion of drainage courses; removal of brick, grate, ring and cover, manhole barrel sections, concrete and any related reinforcing materials, unsuitable material, reducers, etc. to a minimum of 2 foot below finish grade; removal of pavement and sod; cutting and plugging of associated pipe per the Contract Documents, or as required by the Construction Project Manager; salvaging of ring and cover or grates when so designated by the Construction Project Manager; storing of all salvaged materials on the job site at a location designated by the Construction Project Manager; disposal of unsuitable material; placement of approved backfill material and/or Controlled Low Strength Material to final grade elevation, compaction; removal and replacement of paving, curb, gutter, sidewalk, landscaping and any other surface restoration required due to removal of associated item, unless specifically provided for elsewhere in the Contract Documents; and all other related and necessary materials, work, and equipment required to remove, abandon and/or salvage the existing structure in accordance with the Contract Documents.*

- 
- 2-14 Remove Riprap**
  - 2-15 Remove Gabions**

The measurement for payment of this item will be the total number of cubic yards of riprap, gabions or other rock materials required to be removed for construction of the proposed sewer and/or appurtenances; provide, however no measurement for payment will be made for rock required to be removed due to negligence or unauthorized operations by the Contractor.

*The unit price bid shall include all of the Contractor's costs of whatsoever nature. The price bid for removal shall include; excavation, backfilling, removal and disposal of unsuitable material, compaction and all other related and necessary materials, work, and equipment required to remove the riprap or gabions in accordance with the Contract Documents.*

- 
- 2-16.1 Remove Chain Link Fence**
  - 2-16.2 Remove Wood Fence**
  - 2-16.3a Remove Single Swing Gate**
  - 2-16.3b Remove Double Swing Gate**
  - 2-16.4 Remove Security Fence**
  - 2-18 Remove Permanent Barricades**
  - 2-21.1 Remove Guard Rail**

# Measurement and Payment

## **2-21.2 Remove Hand Rail**

The measurement for payment of this item will be the total number of linear feet of wood fence, chain link fence, security fencing, gate work, guard rail, hand rail, or the number of barricades required to be removed for construction of the proposed sewer and/or appurtenances; provided, however, no measurement for payment will be made for items required to be removed due to negligence or unauthorized operations by the Contractor.

*The unit price bid per linear foot of removal shall include all of the Contractor's costs of whatsoever nature. The price bid shall include: removal and disposal of materials to include: concrete bases, rails, posts, pickets, wire, fabric, slats, w-beams, nails, nuts, bolts, fencing, etc.; removal and salvage of materials if determined to be reusable by the Construction Project Manager; filling postholes, backfilling and regrading as necessary to promote drainage and eliminate safety hazards; and all other related and necessary materials, work and equipment required to complete the removal in accordance with the Contract Documents.*

---

## **2-17.1 Remove and Replace/Relocate Utility Poles**

### **2-17.2 Temporary Utility Pole**

### **2-17.3 Remove and Replace/Relocate Sign**

### **2-17.5 Remove and Replace Parking Meter Pole**

The measurement and payment of this item will be the total number of utility poles, parking meter poles and/or signs required to be removed and/or removed and relocated or replaced, and the total number of temporary poles placed and removed, for construction of the proposed sewer and/or appurtenances; provided, however, no measurement for payment will be made for poles removed due to unauthorized operations of the Contractor.

*The unit price bid shall include all of the Contractor's costs of whatsoever nature. The price bid shall include: coordination with the utility owner; adherence to rules and procedures set forth by utility owners; scheduling relocates as required to insure that no time is lost for the project; excavation; removal and storage of poles and/or signs; replacement with new pole and/or signs if necessary; bedding, select fills, backfilling and compaction; removal and replacement of guy wires; drilling, casings; installation of new foundations to utility owner or Construction Project Manager's requirements as necessary; disposal of all trash and construction unsuitable material associated with this bid item; and all other related and necessary materials, labor and equipment required to complete the construction in accordance with the Contract Documents.*

---

## **2-17.7 Relocate Existing Utility**

No quantity measurement will be made for any of the work and materials required to accomplish this aspect of the construction project and payment will be based upon the completion of the work in accordance with the Contract Documents.

*The lump sum cost for coordination and relocation of the specified existing utility line shall include all of the Contractor's costs of whatsoever nature. The price bid shall include: coordination with the utility owner as necessary to complete the relocation; adherence to rules, regulations, specifications and procedures set forth by utility owner; obtaining all required permits and paying associated fees; railroad flagging/inspection and fees as necessary; shoring and trench support; hand digging as necessary; removal and disposal of concrete encasement material; removal and disposal of abandoned appurtenances; scheduling, rescheduling and facilitating all relocations as required to ensure the project stays on time, all associated delay costs; excavation as necessary for relocation of existing utility; removal, disposal and hauling of*

# Measurement and Payment

*all construction debris, excess excavated material, unsuitable materials and manifested contaminated materials at the Denver Arapahoe Disposal Site (DADS), recycle and salvage of materials as required by contract; temporary utility supports; relocation of the utility; providing temporary service and rerouting as necessary; preserving service and continuity as required by utility owner; cutting of existing utility conduit and line as necessary; providing all materials, equipment and specialty labor necessary for reconnection of specific utility; brushing, cleaning and pigging of utility conduit as required by owner; providing and installing marking/tracing wire; concrete encasement of relocated utility as required and per utility company standards; traffic control supporting a standalone configuration; air testing; material testing; relocation engineering and plan development; directional boring if needed; removal and replacement of concrete flatwork at directional bore pits; specialized welding at points of connection and pipe junctions; backfilling and compaction after completion of relocate; and all other related and necessary materials, work and equipment required to relocate the existing utility as required in the Contract Documents or as directed by the Construction Project Manager.*

---

## **2-19 Remove Existing Culvert**

The measurement for payment of this item will be the total number of linear feet of concrete culvert or concrete channel required to be removed for construction of the proposed sewer and/or appurtenances; provided, however, no measurement for payment will be made for removal of culvert due to negligence or unauthorized operations by the Contractor.

*The linear foot price bid for culvert removal shall include all of the Contractor's costs of whatsoever nature. The price bid shall include: excavation, including overexcavation to remove unsuitable foundation material; removal and disposal of all culvert materials including pipe, wood, concrete, reinforcing; backfilling and compaction; and all other related and necessary materials, work and equipment required to remove the culvert in accordance with the Contract Documents.*

---

## **2-20a Remove Trolley Tracks**

## **2-20b Remove Railroad Tracks**

The measurement for payment of this item will be the actual number of linear feet per pair of trolley, street car, or railroad tracks required to be removed for construction; provided, however, no payment will be made for track removed due to negligence or unauthorized operations by the Contractor.

*The unit price bid per linear foot removal of this item shall include all of the Contractor's costs of whatsoever nature. The linear foot price bid (per pair of rails) shall include: removal of paving within the entire track facility footprint and adjacent paving requiring removal to properly complete this item; cutting and disposal; stockpiling, storage and protection; or recycling of rails; removal and disposal of ties, fasteners, spikes, special joints; removal and disposal of special bedding and/or ballast under the tracks, removal and disposal of concrete panels and/or rubber matting; hauling and disposal of all excess excavated at the Denver Arapahoe Disposal Site; backfilling and compaction of subgrade with suitable material; temporary driving surfaces required prior to final pavement or new track installation, maintenance of temporary driving surfaces to includes removal and installation of new temporary surfaces as necessary prior to final treatment; and all other related and necessary materials, work and equipment required for removal of this item in accordance with the Contract Documents.*

---

# Measurement and Payment

---

## **2-22 Remove Parking Lot Trench Drain**

The measurement for payment of this item removal will be the actual number of linear feet of trench drain required to be removed for construction of the proposed sewer and/or appurtenances; provided, however, no payment will be made for trench drain removed due to negligence or unauthorized operations by the Contractor.

*The unit price bid per linear foot removal of this item shall include all of the Contractor's costs of whatsoever nature. The price bid shall include: excavation, removal of concrete, unsuitable material, grates, backfilling and compaction; and all other related and necessary materials, work and equipment required for removal of this item in accordance with the Contract Documents.*

---

## **2-23 Remove Decorative Landscaping**

No quantity measurement will be made for any of the work and materials required to remove and replace this item. Payment will be based upon completion of the work in accordance with the Contract Documents; provided, however, no payment will be made for removing and replacing decorative landscaping required to be replaced due to negligent or unauthorized operations by the Contractor.

*The lump sum bid price shall include all of the Contractor's costs of whatsoever nature. The price bid shall include: excavation; removal and replacement of concrete, rock; removal and replacement of plants; disposal of excess excavated materials; topsoil, fertilizer, water, storage and all other related and necessary materials, work and equipment, required to replace the decorative landscaping in accordance with the Contract Documents.*

---

## **2-24 Remove and Replace Bus Stop**

The measurement and payment of this item will be the total number of bus stops to be removed and replaced for construction of the proposed sewer and/or appurtenances; provided, however, no measurement for payment will be made for bus stops removed and/or replaced due to unauthorized operations by the Contractor.

*The unit price bid shall include all of the Contractor's costs of whatsoever nature. The price bid shall include: coordination with the Regional Transportation District (RTD); adherence to the rules and procedures set forth by RTD; scheduling all necessary relocations and utility disconnections/reconnections, as required, to insure that no time is lost on the project; excavation, removal and disposal of materials as necessary; removal, storage, and replacement of poles, signs, benches, shelters, trash cans, guy wires and all other appurtenances associated with the bus stop; installation and removal of temporary bus stops, as required by RTD; removal and replacement of concrete bus pads, pavement, subgrade material, curb, gutter and sidewalk, landscaping materials and all other items required to complete construction of the proposed sewer and/or appurtenance and replace the bus stop in the same or better condition upon completion; and all other related and necessary materials, labor and equipment required to complete the construction in accordance with the Contract Documents.*



# Measurement and Payment

---

## 3-2 Hauling of Contaminated Materials to Denver/Arapahoe Disposal Site (DADS)

The measurement for payment of this item will be the number of tons of contaminated material required to be hauled off to the Denver/Arapahoe Disposal Site for construction of the proposed sewer and/or appurtenances; provided, however, no measurement for payment will be made for hauling of non-contaminated materials and contaminated materials not authorized by the Construction Project Manager. Payment shall be based upon weights obtained from a certified mobile scale, or at a location agreed to with the Construction Project Manager prior to commencement of activities. Certified weight tickets from the agreed to scale shall be used for payment purposes. Payment shall not be made for muck excavation necessary to poor shoring methods or unauthorized operations by the contractor.

*The unit price bid per ton of contaminated material disposal shall include all of the Contractor's costs of whatsoever nature. The price bid shall include: excavation; identification, storage, loading; hauling, wrapping and obtaining weights on a certified scale prior to disposal; providing a mobile scale, disposal of debris at the Denver Arapahoe Disposal Site; acquisition of all required permits; all special personnel and equipment required to haul the construction debris to DADS; laboratory testing as required; equipment decontamination; fugitive dust control, containment and monitoring; compliance with Denver Environmental Health – Asbestos-Contaminated Soil Management Standard Operating Procedure (current version); management of on-site treatment; stockpiling, profiling, storage and disposal of contaminated materials; implementation and coordination of Federal, State and Municipal Rules and Regulations as required by the respective agencies and governmental entities; all fees and fines associated and all other related and necessary materials, work, and equipment required for removal of this item in accordance with the Contract Documents.*

---

## 3-3 Hazardous Waste Disposal

The measurement for payment of this item will be the total number of tons of hazardous waste required to be removed and hauled off, for construction of the proposed sewer and/or appurtenances; provided, however, no measurement for payment will be made for removal and disposals not authorized by the Construction Project Manager. Payment shall be based upon weights obtained from a certified scale agreed to with the Construction Project Manager prior to commencement of activities. Certified weight tickets from the agreed to scale shall be used for payment purposes. Payment shall not be made for muck excavation necessary to poor shoring methods or unauthorized operations by the contractor.

*The unit price bid per ton of Hazardous Waste disposal shall include all of the Contractor's costs of whatsoever nature. The price bid shall include: all required permits and fees; excavation, loading, hauling and obtaining weights at a certified scale prior to disposal; and backfilling; disposal of hazardous waste at the Denver Arapahoe Disposal Site; and as required by State and Federal regulations; and all other related and necessary materials, work, and equipment required for hazardous waste disposal in accordance with the Contract Documents.*

---

## 3-4 Rock Excavation

The measurement for payment of this item will be the total number of cubic yards of rock required to be removed for construction of the proposed sewer and/or appurtenances; provided, however, no measurement for payment will be made for rock excavation beyond the

## Measurement and Payment

maximum prescribed trench width or for depths exceeding 12 inches below the pipe nor for excavation due to negligence or unauthorized operations by the Contractor.

*The unit price bid per cubic yard of rock excavation shall include all of the Contractor's costs of whatsoever nature required to perform the excavation and to replace the void area with granular bedding and/or any other material specifically approved by the Construction Project Manager. The price bid shall include: excavation, blasting, removal and disposal of rock unsuitable material; furnishing, placing and compacting the approved backfill material required to fill the void area; and all other related and necessary materials, work, and equipment required to excavate the rock in accordance with the Contract Documents.*

---

### 3-5 Muck Excavation

The measurement and payment for this item will be the total number of tons of muck required to be excavated and disposed of; provided, however, no measurement for payment will be made for any excavation of material that does not meet the definition of muck as described in the technical specifications or as determined by the Construction Project Manager. Measurement for muck excavation will be made only to the limits specifically determined by the Construction Project Manager. Payment shall be based upon weights obtained from a certified scale agreed to with the Construction Project Manager prior to commencement of activities. Certified weight tickets from the agreed to scale shall be used for payment purposes. Payment shall not be made for muck excavation necessary to poor shoring methods or unauthorized operations by the contractor.

*The unit price bid per ton of muck removal shall include all of the Contractor's costs of whatsoever nature: The price bid shall include: excavation; loading, hauling and obtaining weights at a certified scale prior to disposal; removal and disposal of muck at the Denver Arapahoe Disposal Site; dewatering; placing and compacting approved select materials in void areas left by the excavation in a timely fashion; and all other related and necessary materials, labor, and equipment required to remove the muck in accordance with the Contract Documents or as directed by the Construction Project Manager.*

---

### 3-6 Construct, Repair, or Stabilize Embankments

The measurement and payment for this item will be the total number of cubic yards of embankment materials required for construction of the proposed sewer and/or appurtenances; provided, however, no payment will be made for embankment materials not authorized by the Construction Project Manager.

*The unit price bid per cubic yard of embankment construction shall include all of the Contractor's costs of whatsoever nature. The price bid shall include: excavation, haul, furnishing and placement of embankment materials, geotextiles, soils, compaction, placement of riprap, concrete, grouting, grading; and all other related and necessary materials, work, and equipment required to construct the embankment in accordance with the Contract Documents.*

---

### 3-7a Health & Safety Plan

No quantity measurement will be made for any of the work and materials required to accomplish this aspect of the construction project and payment will be based upon the completion of the work in accordance with the Contract Documents.

---

# Measurement and Payment

*The lump sum payment for health and safety plans shall include all of the Contractor's costs of whatsoever nature. The lump sum price bid shall include: creation and modification of a Health & Safety Plan, facilities coordination for health and safety; training of all personnel as necessary to perform work; coordination of Federal and Municipal Rules and Regulations as required by the respective agencies and municipalities; all fees, and fines due to non-compliance with regulations, monitoring of the health and safety plan; contaminant testing as required; and all other related and necessary materials, work and equipment required to complete this item in accordance with the Contract Documents.*

*At the option of the Construction Project Manager, monthly percentage payments, based upon Period of Performance, may be paid to the contractor upon satisfactory completion of and/or proper controls submitted in monthly payment applications. At the discretion of the Construction Project Manager, payment may be withheld for any Non-conformance reports issued for failure to comply with the accepted Health & Safety Plan.*

---

## **3-7b Material Management Plan**

No quantity measurement will be made for any of the work and materials required to accomplish this aspect of the construction project and payment will be based upon the completion of the work in accordance with the Contract Documents.

*The lump sum payment for materials management plan shall include all of the Contractor's costs of whatsoever nature. The lump sum price bid shall include: creation of and modification of a Material Management Plan; facilities coordination for health and safety; training of all personnel as necessary to perform work; coordination for testing and disposal of materials; waste classification, profiling and manifesting, protecting workers and the public from exposure to contaminants; decontamination procedures for personnel and equipment; fugitive dust control, containment and monitoring; compliance with Denver Environmental Health – Asbestos-Contaminated Soil Management Standard Operating Procedure (current version); management of on-site treatment, storage and disposal; procurement and stockpiling of lined containers; waste classification, profiling and manifesting; protecting workers and the public from exposure to contaminants; Decontamination of anything exposed to contaminated substances; fugitive dust control and containment including monitoring implementation and coordination of Federal, State and Municipal Rules and Regulations as required by the respective agencies and governmental entities; all fees and fines associated with the Material Management Plan; contaminant testing as required; and all other related and necessary materials, work and equipment required to complete this item in accordance with the Contract Documents.*

*At the option of the Construction Project Manager, monthly percentage payments, based upon Period of Performance, may be paid to the contractor upon satisfactory completion of and/or proper controls submitted in monthly payment applications. At the discretion of the Construction Project Manager, payment may be withheld for any non-conformance reports issued for failure to comply with the accepted Materials Management Plan.*

---

## **3-8 Unclassified Excavation**

### **5-3b Overexcavation**

The accepted quantities will be paid for at the contract unit price for unclassified excavation or overexcavation. The measurement for payment of this item will be the number of cubic yards

# Measurement and Payment

of material required to be removed for construction, excluding demolition and removal items specified elsewhere. The measurement and payment for overexcavation or unclassified excavation shall be defined based on field conditions (insitu) prior to commencing operations (excavated volumes shall not be allowed) and agreed to by the Construction Project Manager. If feasible, a before and after field survey may be conducted to define this volume. In either method, this area shall be defined as the unclassified or over excavation zone. The quantity paid shall not include any material excavated above the proposed facility subgrade, as shown within the contract documents.

*The unit price bid per cubic yard of excavation shall include all of the Contractor's costs of whatsoever nature. The unit price bid shall include: all labor, equipment, materials and incidentals required to excavate the materials, loading, hauling and disposal on-site and off-site to the Denver Arapahoe Disposal Site, and stockpiling of materials; placement as subgrade and/or topsoil elsewhere on site as specified within the contract documents; placement for embankments, water conditioning and compaction to specified limits. Embankment construction will not be measured separately but will be included as a separate unclassified excavation bid item with additional notes.*

---

**5-1 Structural Fill**

**5-2a Subgrade Material (Select Backfill)**

**5-2b Topsoil**

**5-4 Crusher Fines**

**5-5 Recycled Concrete**

**5-8 Crushed Gravel Base Course (CDOT Class 6 Road Base)**

The measurement for payment of this item will be the number of tons of structural fill, subgrade material, topsoil, crusher fines, and/or recycled concrete placed and accepted for construction of the proposed facilities and/or appurtenances. No measurement for payment will be made for materials that are placed without specific written approval of the Construction Project Manager. In addition, no payment will be made for: placement due to poor subgrade preparation, cave-ins, and/or negligent or unauthorized activities by the Contractor. This item shall follow the requirements set forth in Section 5.0 of the Standard Construction Specifications.

All delivery trucks shall be plainly numbered and all records of gross, tare and net weights (determined by use of a certified scale) shall be kept in detail and furnished to the Construction Project Manager upon request. These records will be used for payment purposes, and may be reviewed by the Construction Project Manager at any time.

*The unit price bid per ton of classified material shall include all of the Contractor's costs of whatsoever nature. The price bid shall include; excavation and preparation of subgrade; removal and disposal of all unsuitable materials; furnishing of approved materials, transporting, weighing at a certified scale as required for payment placing, addition of water as necessary and compacting the classified material; finish grading; and all other related and necessary materials, work, labor and equipment required to complete the site preparation and placement of the classified material in accordance with the Contract Documents.*

---

**5-3a Overexcavation and Replacement With Select Backfill Material**

The measurement and payment for this item will be the total number of cubic yards of overexcavation and replacement with select backfill material (and/or stabilization materials

## Measurement and Payment

consisting of 1-1/2 inch angular aggregate as approved by the Construction Project Manager) required to construct the proposed facilities and/or appurtenances; provided, however, no measurement for payment will be made for overexcavation and replacement required due to negligence or unauthorized activities by the Contractor. The measurement for overexcavation and replacement shall start at the proposed pipe or facility subgrade, extend downward as required to produce a stable sub-base for the proposed infrastructure and extend a maximum trench width as defined in the most recent addition of the Standard Detail drawings or a maximum width agreed to by the Construction Project Manager prior to commencing overexcavation. This area shall be defined as the stabilization zone.

Payment will be solely based on the cubic yards of approved select material imported and installed within the stabilization zone defined above. Separate payment will not be made for the overexcavation under this bid item. Select material must conform to the requirements set forth in Section 5.0 of the Standard Construction Specifications. The Contractor must obtain approved submittals for all select materials used under this item from the Construction Project Manager, to ensure that the material proposed for use meets the field conditions and intended use. All delivery trucks shall be plainly numbered and all records of gross, tare and net weights (determined by use of a certified scale) as well as load volumes and weights shall be kept in detail and furnished to the Construction Project Manager upon request. These records will be used for verification purposes during payment and may be reviewed by the Construction Project Manager at any time. All hauling and disposal of construction or contaminated materials generated due to construction activities must be managed in strict conformance with the Standard Construction Specifications.

*The unit price bid per cubic yard of overexcavation and replacement shall include all of the Contractor's costs of whatsoever nature. The unit price bid shall include: trench protection, overexcavation, removal and disposal of material within the stabilization zone, removal and disposal of unsuitable material, hauling and disposal to the Denver Arapahoe Disposal Site (DADS); furnishing and installation of approved select materials, transporting, weighing at a certified scale as required for verification of payment; compaction and installation of approved select materials; dewatering as necessary to allow installation and stabilization of select materials; furnishing and installation of geotextiles or filter fabrics as required in the Contract Documents, and all other related and necessary materials, work, labor and equipment required to complete the removal in accordance with the Contract Documents.*

---

### 5-7 **Controlled Low Strength Material (CLSM)**

The measurement and payment for this item will be the total number of cubic yards of Controlled Low Strength Material, controlled density fill, etc. approved for construction of the proposed facilities and/or appurtenances; provided, however, no measurement for payment will be made for materials required due to careless or unauthorized activities by the Contractor.

*The unit price bid per cubic yard shall include all of the Contractor's costs of whatsoever nature. The price bid shall include: furnishing and hauling; placement, as directed by the Construction Project Manager; maintaining the mixture to the requirements provided for within the Contract Documents; protection of existing facilities; and all other related and necessary materials, work, and equipment required to furnish the material in accordance with the Contract Documents.*

# Measurement and Payment

## 5-9 Permeation Grouting

The measurement and payment for this item will be per linear foot of tunnel center line that requires permeation grouting, as shown in the plans and/or as approved for construction of the proposed facilities and/or appurtenances. This is a one time, linear foot payment per tunnel, from face of structure to face of structure, no further payment will be made for additional permeation grouting needed or for careless or unauthorized activities by the Contractor.

*The unit price bid per linear foot shall include all of the Contractor's costs of whatsoever nature. The price bid shall include and is not limited to: mobilization, demobilization and remobilization of all equipment and materials as necessary to complete the work and/or accommodate access restrictions to property and special requests by property owners; permits, rental fees for offsite storage of equipment and materials; site clearing and construction access necessary for site preparation; dewatering, water control; utility locates and potholing of existing utilities prior to drilling; support of steel casing; removal, transport and disposal of muck; surface monitoring, deep settlement monitoring, surveying, surface pressure tests, monitoring of surface for leakage; design of grout program; development and submittal of a grouting layout plan; installation and removal of sleeve port pipes for grouting operations; supply, mixing, field and lab testing, and installation of chemical grout; monitoring and reporting of grouting operations; clean up and restoration of all surface features effected by grouting operations; abandonment of bore holes; furnishing and hauling; placement, as directed by the Construction Project Manager; maintaining the mixture to the requirements provided for within the Contract Documents; protection of existing facilities; demonstrating the effectiveness of grouting program; additional permeation grouting outside the estimated limits shown in the drawings as necessary for construction and all other related and necessary materials, work, and equipment required to furnish the material in accordance with the Contract Documents.*

---

### 8-1.1 Dip AWWA C151, Class 50 Water Line

### 8-1.3 PVC AWWA C900, Class 200 and Class 150 Water Line

### 8-1.6 PVC AWWA C905 DR18 Water Line

The measurement and payment of each specific size of waterline pipe, except segments as may be otherwise provided for in the Contract Documents, will be the actual number of linear feet of pipe required to be removed and relocated or installed, complete, in place, as measured along the centerline of the waterline pipe from given station to given station, from center of valve to center of valve or from center of manhole to center of manhole with deductions made for the internal diameter or dimensions of manholes, structures and/or valves; provided, however, no measurement for payment will be made for pipe removed or damaged due to negligence or unauthorized operations by the Contractor.

*The unit price bid per linear foot for the construction of each section of waterline shall include all of the Contractor's costs of whatsoever nature for the complete construction of the pipeline in accordance with the requirements of the Board of Water Commissioners of Denver. The price bid shall include: furnishing of temporary sanitary facilities, bottled water and coordinating shut off to correspond with non-work hours, including night and weekends if necessary, payment of all associated inspection fees, trench sloping, benching, bracing, shoring and/or sheeting for pipe and associated appurtenances to assure safe working conditions; removal and disposal of the existing conduit and appurtenances (per State and Local requirements where applicable for lines containing asbestos), including valves, water meter's, stop boxes, fire hydrants, pressure regulating devices, restraints, and fittings; furnishing and installing required waterline pipe,*

## Measurement and Payment

*fittings, appurtenances, temporary facilities and blow offs; tapping and/or connecting to mainlines, installing required copper service line pipe or structures; cutting and/or plugging of all abandoned facilities crossed during construction; furnishing and installing special fittings and restraints, including: transitional pipe sections required to properly connect different types of pipe and/or any other special fittings not specifically provided for elsewhere in the Contract Documents; joints and jointing materials, including: grout, mortar, gaskets, seals, bolts, connecting bands, and other miscellaneous items as required to construct the specific pipe section; removal and disposal of pavement, roadway surface materials, concrete flatwork, sod, landscaping, stumps, brush and any other materials encountered prior to excavation; excavation, including exploratory excavation, as required by the Construction Project Manager; over-excavation to remove unsuitable foundation material and replacement with granular or other approved select materials; constructing the specified bedding including the furnishing, placing, and compaction of sand, gravel, rock and controlled low strength materials, as required by the Denver Water Board; supply and installation of protective coatings or wrappings, locate wires and boxes; backfilling to include furnishing, transporting, and placement of any additional suitable backfill material required (except for those classified backfill materials provided for elsewhere in the Contract Documents); compaction and backfilling as specified (no additional or separate payment will be made for excess excavated material used as backfill or select material elsewhere on the project); restoration of ground surface to its original condition; grading and leveling; care and diversion of drainage courses; pumping and provision of facilities for diversion of flows; trench dewatering; protection, adjustment and/or reconnection of aboveground and underground utilities and service connections, replacement of hydrant laterals and assemblies damaged during crossing, reconnection of water services; coordination of gas service and electric relocates; crossing of existing and abandoned utilities; hauling and disposal of construction debris, excess excavated material, damaged materials and contaminated materials at the Denver Arapahoe Disposal Site (DADS), recycle and salvage of materials as necessary; saw cutting and/or rotomilling within mainline (B<sub>f</sub> extents) and lateral trench extents prior to excavation; removal and replacement and/or relocation of signs, and pipe bollards; providing for additional traffic control, to include barricades, detours and flagmen unless provided for elsewhere in the Contract Documents; removal and replacement of all traffic signal and/or activated loops; valve operation tests, pipe chlorination, clear water tests, pressure tests, locate wire testing; and all other related and necessary materials, labor and equipment required to construct a complete operable pipeline in accordance with the Contract Documents and in accordance with the Denver Water Board Standards.*

*In addition to the above, the unit price bid per linear foot for slip lining, bursting, jacking, tunneling, boring and/or micro tunneling shall include the following: installation of jacking, tunneling and/or boring pits and related equipment; launching and access pits; automated spoil transportation systems; hoists; signal systems, safety equipment; sealing materials, grout, sand, casings, skids and end seals as approved by the Construction Project Manager and as required by the Denver Water Board, filling of all annular spaces and any other necessary labor; purchase, delivery and installation of all equipment and materials required to install the pipe segment and/or associated casing per the Contract Documents; heating and butt fusion jointing; removal and replacement of existing waterlines, valves, hydrants, vaults, restraints, sod, seeding, sprinkler systems, trees, bushes, shrubs, bike path, curb, gutter, sidewalk, pavement, asphalt base course, asphalt wearing surface, and any other surface restoration and/or removal/replacement required within the areas impacted due to these operations.*

# Measurement and Payment

---

## **8-1.2 Install Water Valve, Water Meter and Stop Box**

The measurement and payment for this item will be the total number of water valves, water meters and stop boxes required to be installed for construction of the proposed sewer and/or appurtenances; provided, however, no measurement for payment will be made for items required to be installed due to negligent or unauthorized operations by the Contractor.

*The unit price bid for installation of this item shall include all of the Contractor's costs of whatsoever nature. The price bid shall include: excavation, backfilling and compaction; removal and disposal of the existing water valve, water meter and/or stop box; installing required copper service line or other pipe, installation of the item in accordance with the requirements of the Denver Water Board; supply and installation of all components required to complete the work, including stop(curb) boxes; removal and disposal of pavement and unsuitable material; and all other related and necessary materials, labor, and equipment required for removal and replacement of each item in accordance with the Contract Documents, and in accordance with Denver Water Board Standards.*

---

## **8-1.4 Temporary Water Main Bypass**

The measurement for payment of this item will be the actual number of linear feet from the center of intersection to the center of intersection for the block being bypassed. Every block requiring temporary water main bypass will only be paid once and all work necessary within the block measured shall be included within this item. Only those sections specifically authorized by the Construction Project Manager will be bypassed and measured for payment.

*The unit price bid per linear foot for this item shall include all of the Contractor's costs of whatsoever nature. The price bid shall include: furnishing and setting up of all equipment, labor, and materials required to temporarily bypass the existing water main around the facilities being repaired, reconstructed, or constructed to all properties being served within the effected construction areas and as approved by the Construction Project Manager; installation and maintenance of entire temporary water bypass system during the work to ensure uninterrupted service, safe operation and multimodal access by owners; vacuum breakers and inclement weather devices or procedures to protect system; supply of temporary service connections and fire services in accordance with Denver Water requirements; valve operation tests, pipe chlorination, clear water tests, pressure tests and locate wire testing; permits and fees from applicable entities; compaction and backfilling as specified (no additional or separate payment will be made for excess excavated material used as backfill or select material elsewhere on the project); materials testing and quality control; supplying of energy required to operate all bypass equipment; temporary installation of bypass piping under the pavement of cross streets, or raised transitional crossings as may be required per the approved traffic control plan; temporary surfacing; restoration of ground surface to its original condition including removal and replacement of sod, seeding, sprinkler systems, trees, bushes, shrubs, bike path, curb, gutter, sidewalk, pavement (concrete, asphalt base course, asphalt wearing surface, sub grade materials, etc.) and any other surface restoration and/or removal/replacement within the areas impacted due to these operations; removal and replacement of water fixtures, fire hydrants, valves, or any other appurtenances as necessary*



## Measurement and Payment

*to permit bypassing; hauling and disposal of construction debris, excess excavated material, damaged materials, unsuitable material and contaminated materials at the Denver Arapahoe Disposal Site (DADS); and all other related and necessary equipment, work, and materials required to complete the water bypassing as required in the Contract Documents or as directed by the Construction Project Manager.*

---

### **8-1.5a Lead Service Line Replacement, <2”ID**

### **8-1.5b Lead Service Line Replacement, >2”ID**

The measurement for payment of this item will be the actual number of lineal feet of lead water service line removed and replaced as measured from the corporation stop or tee on the water main to the centerline of the external water meter. Lead services shall be replaced with a minimum size copper service line of  $\frac{3}{4}$ ” or to a size adequate to supply all the requirements of the property being served in accordance with Denver Water specifications and details. No measurement for payment will be made for lead service line replacement required due to negligence or unauthorized operations by the Contractor.

*The unit price bid per lead service line replacement shall include all of the Contractor’s costs of whatsoever nature for the complete removal and replacement of the lead service line in accordance with the requirements of Denver Water, exclusive of appurtenances or items otherwise provided for in the Contract Documents. The price bid shall include: trench sloping, benching, bracing, shoring and/or sheeting for service lines and associated appurtenances to assure safe working conditions; barricades, fencing and signage as necessary to ensure the safety of the public; removal and disposal of the existing lead service line and appurtenances (per State and Local requirements where applicable), including valves, and fittings; furnishing, transporting, and installing required copper service line pipe, fittings, valves, and appurtenances; providing temporary service and facilities as necessary during construction; tapping and/or connecting to mainlines and/or meters; furnishing and installing special fittings for connection to the water meter, not specifically provided for elsewhere in the Contract Documents; gaskets, seals, bolts, connecting bands, and other miscellaneous items as required to construct the service line; saw cutting and/or rotomilling within trench section prior to excavation; removal and disposal of asphalt, millings, roadway surfacing materials, sod, surfacing materials, stumps, brush and unsuitable material prior to excavation; excavation, including exploratory excavation, as required by the Construction Project Manager; over-excavation to remove unsuitable foundation material and replacement with granular or other approved select materials at the specific written approval of the Construction Project Manager; constructing the specified bedding including the furnishing, placing, and compaction of sand, gravel, rock or controlled low strength materials, as required by Denver Water; supply and installation of protective coatings or wrappings, locate wires and boxes; backfilling to include furnishing, transporting, and placement of any additional suitable backfill material required (except for those classified backfill materials provided for elsewhere in the Contract Documents); compaction and backfilling as specified (no additional or separate payment will be made for excess excavated material used as backfill or select material elsewhere on the project); grading and leveling; restoration of ground surface to its original condition including the removal and replacement of sod, seeding, sprinkler systems, trees, bushes, shrubs, bike path, curb, gutter, sidewalk, pavement, asphalt base course, asphalt wearing surface and any other surface restoration and/or removal/replacement required within areas impacted due to these operations; care and diversion of drainage courses; trench dewatering; protection, adjustment and/or reconnection of aboveground and underground utilities; coordination of gas service and electric relocates; crossing of existing and abandoned*

# Measurement and Payment

utilities; hauling and disposal of construction debris, excess excavated material, damaged materials and contaminated materials at the Denver Arapahoe Disposal Site (DADS); removal and replacement and/or relocation of signs, and pipe bollards; providing for additional traffic control, to include barricades, detours and flagmen as specified per the approved MHT/Street Occupancy permit; removal and replacement of all traffic signal and/or activated loops; valve operation tests, pipe chlorination, clear water tests, pressure tests, locate wire testing; permits and fees from applicable entities; and all other related and necessary materials, labor and equipment required to construct a complete operable water service line in accordance with the Contract Documents and in accordance with Denver Water specifications and standards.

---

## **8-2 Remove Fire Hydrant Assembly**

The measurement and payment for this item will be the total number of fire hydrants required to be removed for construction of the proposed sewer and/or appurtenances; provided, however, no payment will be made for hydrants replaced due to negligent or unauthorized operations by the Contractor.

*The unit price bid for removal of this item shall include all of the Contractor's costs of whatsoever nature. The price bid shall include: excavation; removal and disposal(or recycling as applicable) of hydrant, fittings, restraints, valves and appurtenances; plugging and capping of hydrant service line as required; backfilling and compaction; removal and disposal of pavement and unsuitable material; and all other related materials, work, and equipment required for removal of this item in accordance to the Contract Documents, and in accordance to the Denver Water standards.*

---

## **8-3 Reset or Install Fire Hydrant Assembly**

The measurement and payment for this item will be the total number of fire hydrants required to be reset and/or placed for construction of the proposed sewer and/or appurtenances; provided, however, no payment will be made for hydrants reset and/or installed without authorization by the Construction Project Manager or due to negligent operations of the Contractor.

*The unit price bid for this item shall include all of the Contractor's costs of whatsoever nature. The price bid shall include: excavation; furnishing, installation and assembly of all materials including but not limited to: hydrant, risers, fittings, restraints, valves and appurtenances; resetting existing hydrants as permitted; backfilling and compaction; removal and disposal of pavement and unsuitable material; operation tests, chlorination tests, clear water tests, pressure tests, and all other related and necessary materials, work, and equipment required for installation of the fire hydrant assembly in accordance with Denver Water standards.*

---

- 12-1.1 6" Curb and Gutter – 2' Pan (CDOT T2, IIB)**
  - 12-1.2 6" Curb and Gutter – 1' Spill Pan (CDOT T2 IB)**
  - 12-1.4 9" Curb and Gutter**
  - 12-1.5 Combination Curb, Gutter and Sidewalk (2'-8")**
  - 12-1.6 Combination Curb, Gutter and Sidewalk (3'-11")**
  - 12-1.6a Combination Curb, Gutter and Sidewalk (4'-11")**
  - 12-1.7 6" Concrete Curb Head**
-

# Measurement and Payment

- 12-1.8 Handicap Concrete Curb Ramp
- 12-1.9 Gutter Overlay
- 12-2.1 Concrete Sidewalk
- 12-2.2 Reinforced Concrete Sidewalk
- 12-2.3 Concrete Bike Path
- 12-2.4 Miscellaneous Concrete Flatwork
- 12-3 Concrete Valley Gutter (all sizes)
- 12-4.1 Concrete Street Intersection Gutter (Crossspan)
- 12-4.2 Concrete Street Intersection Gutter with Slot
- 12-4.3 Special Precast Concrete Intersection Gutter
- 12-5.1 Concrete Driveway Paving
- 12-5.2 Concrete Apron
- 12-5.3 Concrete Bus Pad
- 12-5.4 Concrete Alley Gutters
- 12-5.5 Concrete Alley Paving
- 12-5.6 Concrete Alley Returns
- 12-5.7 Concrete Street Paving
- 12-6 Concrete Median Strip
- 12-8 Concrete Steps

The measurement and payment for installation of this item will be the total number of linear feet for: gutter overlay, curb and gutter, curb head, combination curb gutter and sidewalk, or the total number of square feet for: median strips, sidewalk, bike path, driveway pavement, street paving, crossspans, handicap curb ramps, alley paving, alley gutters, alley returns, single or double flare aprons, bus pads, valley gutter, concrete steps or any other type of miscellaneous concrete flatwork placed and accepted; provided, however, no measurement and payment will be made for flatwork placed due to careless or unauthorized operations by the Contractor.

All concrete ingredients and additives must be combined and mixed at the batch plant prior to transport. Onsite additions to the concrete mix, of any type, will not be allowed without prior authorization of the Construction Project Manager.

*The unit price bid per square foot of concrete steps shall be quantified by the width of the stairs multiplied by the summation of each stair hypotenuse (the hypotenuse of the rise and run of each stair). The unit price bid per linear foot or square foot placement of these items shall include all of the Contractor's costs of whatsoever nature. The price bid shall include: sawcutting and/or rotomilling surrounding surface to allow placement, removal of pavement or roadway surfacing; concrete sawing, furnishing and placing the concrete; forming, finishing and curing compounds; contraction and expansion joints where required by Construction Project Manager, including partial depth sawcuts; joint sealing compounds; reinforcing as required and specified; providing high early concrete as necessary to meet specific project needs; concrete additives including, but not limited to: set retarders, accelerators and polypropylene fibrillated fibers as directed and approved by Construction Project Manager; edging the concrete surface; furnishing, transporting, installing and compaction of materials required for a stable sub-base; removal and disposal of unsuitable subgrade materials (including frost), replacement with suitable backfill as necessary; backfilling and pavement around new flatwork; protection from freezing and vandalism; and all other related and necessary materials, work and equipment required to construct this item in accordance with the Contract Documents.*

# Measurement and Payment

---

- 12-7 Non-reinforced Concrete Median Barrier**
- 12-9 Concrete Headwall**
- 12-10 Concrete Lined Ditches**
- 12-11 Concrete Planters**
- 12-12 Concrete Cradle for Class "A" Bedding**
- 12-13 Concrete Encasement around Pipe**
- 12-14 Concrete Cut-Off Wall**
- 12-16a Concrete Retaining Wall**
- 12-16b Block Retaining Wall**

The measurement for payment of bulk concrete items such as median barriers, cradles, encasements, cut off walls, lined ditches and planters will be the total number of cubic yards of concrete required for construction. The measurement and payment for retaining walls will be a lump sum payment for each wall and type as indicated in the contract documents. The measurement and payment for headwalls will be based upon the actual number required as indicated within the contract documents for construction of the proposed sewer and/or appurtenance. No payment will be made for any of these items replaced due to negligent or unauthorized operations by the Contractor.

*The unit price bid per cubic yard, lump sum or each for these items shall include all of the Contractor's costs of whatsoever nature. The price bid shall include: furnishing, transporting, and installing concrete materials, steel reinforcement, add mixtures and fiber reinforcement as required, and block materials; excavation and overexcavation; furnishing, transporting and installing necessary subgrade, bedding and drainage materials, forming and curing compounds; finishing and edging of concrete; winter protection; backfilling and compaction; grinding, patching and finishing of concrete wall surfaces, application of wall finishes as indicated in the contract documents, installation and furnishing of all fence and/or railing noted for individual wall segments; hauling and disposal of construction debris, excess excavated material, damaged materials and contaminated materials to the Denver Arapahoe Disposal Site (DADS); and all other related and necessary materials, work and equipment required to construct this item in accordance with the Contract Documents.*

- 
- 16-1 Security Fence**
  - 16-2a Single Swing Gate**
  - 16-2b Double Swing Gate**
  - 16-3 Chain Link Fence**
  - 16-4 Wood Fence**
  - 16-5 Single Steel Post Guardrail**
  - 16-6 Single Wood Post Guardrail**
  - 16-7 Permanent Barricades**
  - 16-8 Hand Rail**

The measurement and payment for this item will be the total number of linear feet of security fence with view obscuring material (privacy screen), chain link fence, wood fence, guardrail, hand rail, and permanent barricades or the total number of swing gates required to be placed for construction, as agreed upon by the Construction Project Manager; provided, however, no measurement for payment will be made for fence work required to be placed due to negligence or unauthorized operations by the Contractor.

# Measurement and Payment

*The unit price bid per lineal foot or per item placement shall include all of the Contractor's costs of whatsoever nature. The price bid shall include: furnishing and placement of new fencing materials to the height specified in the Contract Documents, including rails, posts, pickets, hardware, locks, paints, special treatments, concrete for posts, single swing gates, double swing gates, steel posts for guard rail, guard rail, wood posts; maintenance, relocation and removal of security fencing, hand rails; replacement of electric outlets, security wire (barbed, razor, etc.) and all other related and necessary materials, work and equipment required to construct the fence work in accordance with the Contract Documents.*

---

## **20-1 Asphalt Temporary Patching**

The measurement for payment of this item will be the actual number of square yards per inch of asphalt temporary patching mix placed, complete and in place, after the area has been properly backfilled and compacted, as required for the proposed sewer and/or appurtenances; provided, however, no measurement for payment will be made for asphalt temporary mix placed in areas not specifically approved by the Construction Project Manager, or required due to careless or unauthorized operation by the Contractor.

The asphalt temporary mix may consist of either hot or cold asphaltic surface material. Unless otherwise specified in the Contract Documents, the minimum thickness of asphalt temporary patching mix required is two inches (2").

*The unit price bid per square yard per inch of asphalt temporary patching mix shall include all of the Contractor's costs of whatsoever nature for the complete construction of the sewer, appurtenances, street or items otherwise indicated within the Contract Documents. The price bid shall include: all preparatory work for placement to grade; disposal of construction debris and unsuitable materials at the Denver/Arapahoe Disposal Site (DADS); street sweeping; removal and disposal of backfill or subgrade materials to the required elevation and preparation for temporary asphalt placement; temporary asphalt material, hauling, rolling, and compaction; maintenance of the temporary patch to include regrading, recompacting, and renewing the material at sufficient intervals of time to ensure a smooth, dust/mud free driving and/or walking surface; temporary striping as required; removal and disposal of temporary asphalt mix prior to permanent asphalt paving operations; and all other related and necessary materials, work and equipment required to furnish and place the asphalt temporary patch in a manner satisfactory to the Construction Project Manager and in accordance with the Contract Documents.*

---

## **20-2 Asphalt Surface Course**

The measurement for payment of this item will be the actual number of square yards per inch of hot mix asphalt surface course, in place, complete, and accepted by the Construction Project Manager, as required for construction of the proposed improvements in accordance with the Contract Documents; provided, however, no measurement for payment will be made for hot mix asphalt surface course placed in areas not specifically approved by the Construction Project Manager, nor required due to careless or unauthorized operation by the Contractor.

Unless otherwise directed by the Construction Project Manager, the hot mix asphalt surface course shall be placed at a minimum of two-inch (2") thickness and only in the areas indicated within the Contract Documents. This item may be used for work within the trench limits and/or outside the trench limits as indicated within the Contract Documents and as directed by the Construction Project Manager.

## Measurement and Payment

*The unit price bid per square yard per inch for hot mix asphalt surface course shall include all of the Contractor's costs of whatsoever nature for the complete construction of the proposed sewer, appurtenances, street or items otherwise indicated within the Contract Documents. The price bid shall include: obtaining all necessary permits and paying any associated fees; additional milling and/or sawcutting of the existing pavement to ensure a smooth and square joint between existing and new pavement; loading, hauling, and disposal of existing asphalt, all related construction debris and unsuitable materials at the Denver/Arapahoe Disposal Site (DADS); recycling of appropriate materials generated during the work; asphalt tack coat; hot mix asphalt, hauling, placing, rolling, and compaction; raising of manhole rings; street sweeping and clean up; traffic control not provided for elsewhere in this Contract Documents; temporary striping as required; QC testing; and all other necessary materials, work, and equipment required for placement of the hot mix asphalt surface course in a manner satisfactory to the Construction Project Manager and in accordance with the Contract Documents.*

---

### 20-3 Asphalt Base Course

The measurement for payment of this item will be the actual number of square yards per inch of hot mix asphalt base course, in place, complete, and accepted by the Construction Project Manager, as required for construction of the proposed improvements in accordance with the Contract Documents; provided, however, no measurement for payment will be made for hot mix asphalt base course placed in areas not specifically approved by the Construction Project Manager, nor required due to careless or unauthorized operation by the Contractor.

Unless otherwise directed by the Construction Project Manager, the hot mix asphalt base course paving shall be placed to the depth and only in the areas specified in the Contract Documents. This item may be used for work within the trench limits and/or outside the trench limits as indicated within the Contract Documents and as directed by the Construction Project Manager.

*The unit price bid per square yard per inch of hot mix asphalt base course shall include all of the Contractor's costs of whatsoever nature for the complete construction of the proposed sewer, appurtenances, street or items otherwise indicated within the Contract Documents. The price bid shall include: obtaining all necessary permits and paying any associated fees; saw cutting and/or milling the existing pavement smoothly and squarely in a manner satisfactory to the Construction Project Manager to assure a smooth joint (ripping and wheel-cutting is not permitted); loading, hauling, removal and disposal of existing asphalt pavement, unsuitable material and excess excavated material at the Denver/Arapahoe Disposal Site (DADS); subgrade preparation, backfilling and compaction to include furnishing, transporting and placement of any additional suitable backfill material required; recycling of appropriate materials generated during the work; asphalt tack coat; hot mix asphalt, hauling, placing, rolling, and compaction; street sweeping and clean up; traffic control not provided for elsewhere in the Contract Documents; temporary striping as required; QC testing; and all other necessary materials, work, and equipment required for placement of the hot mix asphalt base course in a manner satisfactory to the Construction Project Manager and in accordance with the Contract Documents.*

---

### 20-4 Asphalt Rotomilling

The measurement for payment of this item will be the actual number of square yards per inch of asphalt or concrete material rotomilled to the depth specified within the Contract Documents or as directed by the Construction Project Manager to complete the proposed street paving. No measurement for payment will be made for asphalt or concrete rotomilled in areas which

# Measurement and Payment

are not specifically approved by the Construction Project Manager, indicated within the Contract Documents or required due to careless or unauthorized operations by the Contractor.

No measurement for payment will be made under this bid item for rotomilling within the designated pipe trench limits or other miscellaneous areas where sewer, appurtenances or associated flatwork are to be constructed. These costs shall be included in the unit price bid for the related pipe, structures, or appurtenances and are provided for elsewhere in the Contract Documents. This pay item will be used to pay for rotomilling required after installation of the proposed sewer and/or appurtenances for milling on either side of the trench limits prior to placement of the asphalt base and/or surface course, and as specified within the Contract Documents or as directed by the Construction Project Manager.

*The unit price bid per square yard per inch of rotomill shall include all of the Contractor's work of whatsoever nature for the complete construction as indicated within the Contract Documents. The price bid shall include: obtaining all necessary permits and paying any associated fees; loading; hauling, removal and disposal of unsuitable materials, millings and excess excavated material at the Denver/Arapahoe Disposal Site (DADS) or recycling as appropriate; traffic control not provided for elsewhere in the Contract Documents; street sweeping; surface preparation; and all other necessary materials, work, and equipment required for rotomilling in a manner satisfactory to the Construction Project Manager and in accordance with the Contract Documents.*

---

## 20-5 Asphalt Patch

The measurement for payment of this item will be the actual number of square yards per inch thickness of hot mix asphalt used for asphalt patching purposes, complete, in place and accepted by the Construction Project Manager; provided, however, no measurement for payment will be made for asphalt patching placed in areas not specifically approved by the Construction Project Manager, or required due to careless or unauthorized operations by the Contractor.

This pay item will be used to pay for asphalt material used outside the limits established in Pay Items 20-2 and 20-3. This pay item will be used to pay for replacement of street paving outside the normal specified limits in areas deemed necessary by the Construction Project Manager.

*The unit price bid per square yard per inch of thickness of hot mix asphalt patching shall include all of the Contractor's costs of whatsoever nature. The price bid shall include: obtaining all necessary permits; paying any associated fees; saw cutting and/or milling the existing pavement smoothly and squarely in a manner satisfactory to the Construction Project Manager to assure a smooth joint (ripping and wheel-cutting is not permitted); loading, hauling, removal and disposal of existing asphalt pavement, rotomillings, unsuitable material and/or excess excavated material; subgrade preparation, backfilling and compaction of subgrade to include furnishing, transporting and placement of any additional suitable backfill material required; asphaltic tack coat; fresh asphalt hauling, placing, rolling, and compaction; street sweeping and clean up; traffic control not provided for elsewhere in the Contract Documents; temporary striping as required; QC testing; and all other necessary materials, work, and equipment required for placement of the hot mix asphalt trench pavement in a manner satisfactory to the Construction Project Manager and in accordance with the Contract Documents.*

# Measurement and Payment

---

## 20-6 Placement (Only) For Recycled Asphalt

The measurement for payment of this item will be the actual number of square yards per inch thickness of recycled asphalt pavement placed, complete, in place, and accepted by the Construction Project Manager, as required for construction of the proposed sewer and/or appurtenances; provided, however, no measurement for payment will be made for recycled asphalt pavement placed in areas not specifically approved by the Construction Project Manager, or required due to careless or unauthorized operations by the Contractor, or pavement damage caused by the Contractor's equipment or method of operation.

*The unit price bid per square yard per inch of recycled asphalt shall include all of the Contractor's costs of whatsoever nature for the complete construction of the proposed sewer, appurtenances, or items otherwise provided for elsewhere in the Contract Documents. The price bid shall include: obtaining all necessary permits and paying all associated fees; saw cutting to achieve a smooth joint; asphalt tack coat; asphalt hauling, placement, rolling, and compaction; disposal of unsuitable material; street sweeping and cleanup; and all necessary materials, work, and equipment required to furnish and place the recycled asphalt pavement smoothly and squarely in a manner satisfactory to the Construction Project Manager in accordance with the Contract Documents.*

---

## 20-7 Install Asphalt Path

The measurement and payment for this item will be the actual number of square yards per inch thickness of hot mix asphalt placed to the dimensions shown in the Contract Documents or as directed by the Construction Project Manager, complete, in place, accepted, and as required for construction of the proposed sewer and/or appurtenances; provided, however no measurement for payment will be made for asphalt path placed in areas not specifically approved by the Construction Project Manager or required due to careless or unauthorized operations by the Contractor.

*The unit price bid per square yard per inch of hot mix asphalt shall include all of the Contractor's costs of whatsoever nature for the complete construction of the proposed sewer, appurtenances, or items otherwise provided for elsewhere in the Contract Documents. The price bid shall include: obtaining all necessary permits and paying all associated fees; saw cutting to achieve a straight joint; weed removal, grubbing, subgrade preparation, removal and disposal of unsuitable material and excess excavated material, placement of select subgrade material as necessary, compaction, installation of weed block fabric; asphalt tack coat; asphalt hauling, placement, rolling, and compaction; permanent stripping as required; disposal of unsuitable material; street sweeping and cleanup; and all necessary materials, work, and equipment required to furnish and place the hot mix asphalt path smoothly and squarely in a manner satisfactory to the Construction Project Manager in accordance with the Contract Documents.*

---

## 20-8 Asphalt Curb Head

The measurement for payment of this item will be the total number of linear feet of asphalt curb head required to be placed for construction of the proposed sewer and/or appurtenances; provided, however, no measurement for payment for asphalt curb will be made for curb head required to be placed due to negligence or unauthorized operations by the Contractor.



## Measurement and Payment

*The unit price bid for placement of this item shall include all of the Contractor's costs of whatsoever nature. The price bid shall include: asphalt hauling, placement, rolling, compaction, shaping; excavation, backfilling and compaction; stabilizing the sub base; establishing grade; providing all labor, equipment and materials required to place asphalt curb as required and specified in the Contract Documents; disposal of excess or unsuitable materials including asphalt, concrete, landscaping materials etc; saw cutting, milling; street sweeping and clean up; traffic control not provided for elsewhere in the Contract Documents; asphalt tack coat; replacement and reestablishment of landscaping, sod, seed, irrigation systems and/or any other items impacted during placement of this item; and all other related and necessary materials work and equipment required to place this item in accordance with the Contract Documents or at the direction of the Construction Project Manager.*

---

### **20-9a Saw Cut Asphalt/Concrete (0-150 LF)**

The measurement and payment for saw cutting from 0-150 linear feet will be the actual number of linear feet up to 10-inches of depth of asphalt or concrete that is saw cut and accepted; however, no measurement for payment will be made due to negligent or unauthorized operations by the Contractor.

*The unit price bid will be the actual number of linear feet of asphalt or concrete that is saw cut to the full depth and shall include all of the Contractor's costs of whatsoever nature. The unit price bid shall include but not be limited to: mobilization, traffic control, surface preparation, clean up and disposal of debris, fugitive dust control, slurry removal and protection of storm water inlets; protection of utilities, street cut and occupancy permits, and all other related and necessary materials, work and equipment required to complete the saw cut as directed by the Construction Project Manager and in accordance with the Contract Documents.*

---

### **20-9b Saw Cut Asphalt/Concrete (>150 LF)**

The measurement and payment for saw cutting distances greater than 150 lineal feet will be the actual number of linear feet up to 10-inches of depth of asphalt or concrete that is saw cut and accepted; however, no measurement for payment will be made due to negligent or unauthorized operations by the Contractor.

*The unit price bid will be the actual number of linear feet of asphalt or concrete that is saw cut to the full depth and shall include all of the Contractor's costs of whatsoever nature. The unit price bid shall include but not be limited to: mobilization, traffic control, surface preparation, clean up and disposal of debris, fugitive dust control, slurry removal and protection of storm water inlets; protection of utilities, street cut and occupancy permits, and all other related and necessary materials, work and equipment required to complete the saw cut as directed by the Construction Project Manager and in accordance with the Contract Documents.*

---

### **21-1 Concrete Pavement**

The measurement and payment for this item will be the actual number of square feet of concrete placed and accepted; provided, however, no measurement for payment will be made for concrete pavement outside of the prescribed trench width or other dimensions as shown in the Contract Documents. Pavement required to be replaced due to careless or unauthorized operations by the Contractor will not be included in the amount computed for payment.

---

# Measurement and Payment

All concrete ingredients and additives must be combined and mixed at the batch plant prior to transport. Onsite additions, to the concrete mix, of any type will not be allowed without prior authorization of the Construction Project Manager.

*The unit price bid per square foot of pavement shall include all of the Contractor's costs of whatsoever nature. The price bid shall include: forming, reinforcing chairs or supports as required by the Construction Project Manager, concrete, reinforcement, doweling; excavation; disposal of unsuitable material; curing compounds; contraction and expansion joints where required by Construction Project Manager, including partial depth sawcuts; joint sealing compounds; reinforcing as required and specified; providing high early concrete as necessary to meet specific project needs; concrete additives including, but not limited to; set retarders, accelerators and polypropylene fibrillated fibers as directed and approved by Construction Project Manager; finishing and edging; furnishing, transporting, installing, and compaction of all materials required for a stable subbase; removal and disposal of excess subgrade materials; QC testing; and all other related and necessary materials, work and equipment required to construct the pavement in accordance with the Contract Documents.*

---

## **22-1 Earthwork**

The measurement and payment for this item will be the total number of square yards of material to be removed and/or filled for construction as shown in the plans. The measurement for payment of this item will be based on the actual surface area within the footprint of the proposed embankment prior to construction activities.

The unit bid price per square yard of earthwork shall include: all labor, equipment, material, subcontractors and incidentals required to perform earthwork as identified within the contract documents; clearing and grubbing; excavation; loading, hauling and disposal of excess excavated material and debris, stockpiling as necessary; hauling, procurement, placement and compaction of embankment materials as required; grading; diversion of water courses and/or dewatering operations as necessary; compaction to specified limits; excavation below the grades shown on plans to remove unsuitable foundation material, replacement of unsuitable foundation materials with suitable select materials; QC testing; and all other materials, work and equipment required to complete the construction in accordance with the contract documents.

---

## **27-1 Steel Sheet Piling**

The measurement and payment for this item will be the actual number of horizontal lineal feet of steel sheet piling installed, regardless of depth needed, accepted, and left in place (or removed after completion of construction activities) up to one foot above the top of the new sewer pipe and/or appurtenance or the utility being protected. Provided, however, no measurement for payment will be made for steel sheet piling placed due to careless or unauthorized operations by the Contractor.

*The unit bid price per linear foot of steel sheet piling shall include all of the Contractor's costs of whatsoever nature. The price bid shall include: placement, excavation, materials, diversion of water courses, welding where required, removal where applicable, backfilling and compaction; cutting of the steel sheeting smoothly and squarely in a manner satisfactory to the Construction Project Manager.*

# Measurement and Payment

---

- 30-1 Riprap**
- 30-2 Grouted Rip Rap**
- 30-2a Grouted Boulders (2-Foot Diameter)**
- 30-2b Grouted Boulders (3-Foot Diameter)**
- 30-2c Grouted Boulders (5-Foot Diameter)**
- 30-2k Boulder (4-Foot Diameter)**
- 30-2l Boulder (5-Foot Diameter)**
- 30-3 Rock Filled Gabions**
- 30-4 Derrick Stone/Riprap Outfall**

The measurement for payment of this item will be the total number of square yards of riprap, soil riprap, grouted riprap, grouted boulders and/or derrick stone, or the total number of boulders, or the total number of tons used for rock filled gabions required to be furnished and placed on site for construction of the proposed sewer and/or appurtenances; provided, no measurement for payment will be made for items installed due to careless or unauthorized operations by the Contractor.

*The unit price bid per square yard of riprap, soil riprap, grouted riprap, grouted boulders and derrick stone, shall be quantified based on the area of the installed surface directly parallel with the ground. The unit price bid per square yard, per ton, or per boulder shall include: clearing and grubbing; excavation; preparation of bedding/subgrade areas to include over excavation, furnishing, transporting, installing and compaction of all materials required for a stable sub-base and as shown in the details; removal and disposal of excess excavated materials; diversion of water courses and/or dewatering operations as necessary; supply and installation of filter and/or stabilization materials; filter and riprap drains; drain materials; concrete and/or grout; grouting of riprap or boulders; placing of riprap or boulders to the elevations shown on the Contract Documents or as directed by the Construction Project Manager; mattress units and materials for rock filled gabions; overexcavation and replacement with suitable materials; hauling and placing of all materials; and all other materials, work and equipment required to complete construction in accordance with the Contract Documents.*

- 
- 30-2e 36" Grouted Boulder Edge**
  - 30-2f 48" Grouted Boulder Edge**

The measurement and payment of this item will be the total linear feet of boulder edge required to be furnished and placed on site for construction of the proposed channel; provided, no measurement for payment will be made for items installed due to careless or unauthorized operations by the Contractor.

*The unit price bid per linear foot of boulder edge shall be quantified based on the length of installed boulder along the proposed channel edge. The unit price bid per linear foot of boulder shall include: excavation; preparation of bedding/subgrade areas to include over-excavation as necessary; clearing and grubbing; furnishing, transporting, installing and compaction of all materials (bedding, rip rap, rock, or select fill) required for a stable sub-base and as shown in details; removal and disposal of excess excavated materials; diversion of water courses and/or dewatering operations as necessary placing of boulders to the elevations shown on the Contract Documents or as directed by the Construction Project Manager; grouting of boulders as shown in the details; installation of weep holes*

## Measurement and Payment

*as required; hauling and placing of all materials; and all other materials, work and equipment required to complete construction in accordance with the Contract Documents.*

- 
- 34-2 C-76 RCP**
  - 34-3 C-361 RCP**
  - 34-4 C-506 ARCH Pipe**
  - 34-5 C-507 RCP**
  - 34-6.1 Box Culvert - Cast-In-Place**
  - 34-6.2 Box Culvert - Precast**
  - 34-7.1 PVC Pipe**
  - 34-7.2 PVC Slipliner Pipe**
  - 34-7.3 PVC Pipe with Steel Casing**
  - 34-8.1 HDPE SDR 17 Pipe By Bursting (PE 345434E)**
  - 34-9.1 ASTM A746 D.I. Pipe**
  - 34-10.4 Steel Casing Pipe BY JACKING/BORING with Centrifugally Cast Concrete Liner**
  - 34-10.5 Steel Pipe by JACKING/BORING**
  - 34-11.1 PVC Pipe By Jacking/Boring With Steel Casing**
  - 34-11.2 C-76 RCP, Class V By Jacking/Boring, Joint Type R-2**
  - 34-11.3 C-361 RCP By Jacking/Boring (see notes for class & cover depth)**
  - 34-11.4 HDPE SDR 17 Pipe By Jacking/Boring With Steel Casing (PE 345434E)**
  - 34-11.5 C-76 RCP, Class III By Jacking/Boring With Steel Casing**
  - 34-11.6 RPMP By Jacking/Boring**
  - 34-11.7 C-76 RCP, Class III By Jacking/Boring, Steel Bell Band**
  - 34-11.8 C-76 RCP, Class V By Jacking/Boring, Steel Bell Band**
  - 34-11.9 RPMP by Open Cut**
  - 34-11.10 RCBC By Jacking/Boring**

The measurement and payment of each specific size or type of pipe, except segments as may be otherwise provided for in the Contract Documents, will be the actual number of linear feet of sewer pipe installed, complete, in place, as measured along the centerline of the pipe from inside face of manhole to inside face of manhole, from inside face of manhole to given station, from given station to given station, or from center of manhole to center of manhole with deductions made for the internal diameter or dimensions of manholes and/or structures. Where special fittings have been specified and provided for elsewhere in the Contract Documents, deductions will be made for their lengths.

Open Cut

*The unit price bid per linear foot for the construction of each section of pipeline shall include all of the Contractor's costs of whatsoever nature for the complete construction of the pipeline, exclusive of manholes, appurtenances, or items otherwise provided for in the Contract Documents. The bid item shall include: trench sloping, benching, bracing, shoring and/or sheeting for pipe and associated appurtenances to assure safe working conditions; design of shoring, stamping and approval by an Engineer licensed in the State of Colorado, submittal as required; furnishing, transporting and installing all pipe and materials; tapping and/or connecting to mainline pipes, structures, stub outs or block outs; concrete coring; plugging of all abandoned lines crossed during construction; furnishing and installing special fittings, including: trash racks, concrete pipe plugs as required, transitional pipe sections required to properly*

## Measurement and Payment

*connect different classes of pipe without a manhole or structure and any other special fittings not provided for elsewhere in the Contract Documents; joints and jointing materials, including: grout ,mortar, fiberglass resin, gaskets, seals, bolts, concrete collars, connecting bands, and other miscellaneous items as required to construct the specific pipe joint per manufacturer and City standards; saw cutting and/or rotomilling within mainline (B<sub>f</sub> extents) and lateral trench extents prior to excavation; removal and disposal of pavement, roadway surface materials, concrete flatwork, sod, landscaping, stumps, brush, unsuitable material within the trench width and any other materials encountered prior to excavation; excavation, including exploratory excavation, as required by the Construction Project Manager; over-excavation to remove unsuitable foundation material and replacement with granular or other approved select materials; constructing the specified bedding including the furnishing, placing, and compaction of sand, gravel and rock as required for class B bedding or approved substitution; supply and installation of protective coatings or wrappings; backfilling to include furnishing, transporting, and placement of any additional suitable backfill material required (except for those classified backfill materials provided for elsewhere in the Contract Documents); compaction and backfilling as specified, no additional or separate payment will be made for excess excavated material used as backfill or select material elsewhere on the project; restoration of ground surface to its original condition; grading and leveling; care and diversion of drainage courses; pumping and provision of facilities for diversion of flows; trench dewatering; protection and adjustment of aboveground and underground utilities and service connections or laterals, including water service reconnections and adjustments; sanitary sewer encasement; adjustment and reconnection of sanitary sewer services from mainline sewer to a point where proper connection and drainage can be achieved, unless provided for elsewhere in the Contract Documents; removal and replacement of hydrant laterals and assemblies damaged or relocated during crossing; coordination of gas service and electric relocates; crossing of existing and abandoned utilities; cutting and/or plugging of abandoned or crossed lines where indicated in the Contract Documents, or as directed by the Construction Project Manager; hauling and disposal of construction debris, excess excavated material, damaged materials, unsuitable materials and manifested contaminated materials at the Denver Arapahoe Disposal Site (DADS), recycle and salvage of materials as necessary; removal and replacement and/or relocation of signs, and pipe bollards; providing for additional traffic control, to include barricades, detours and flagmen unless provided for elsewhere in the Contract Documents; removal and replacement of all traffic signal and/or activated loops; QC testing for all associated work components; and all other related and necessary materials, labor and equipment required to construct a complete operable pipeline in accordance with the Contract Documents.*

### *Tunneling*

*In addition to the above, the unit price bid per linear foot for slip lining, bursting, jacking, tunneling, boring and/or micro tunneling shall include the following: installation of jacking, tunneling and/or boring pits, intermediate jacking stations, rescue pits and related equipment; launching and access pits; design of bracing/shoring for all pits by an Engineer licensed in the State of Colorado; dewatering and water control; installation and maintenance of pit safety equipment; removal of shaft support systems; utility coordination, locating and potholing within pit and tunnel locations prior to starting construction operations; compensation grouting, all equipment and materials necessary to complete this work, developing and submitting detailed grout programs; installation of grout pipes; monitoring, recording and reporting of grouting operations; associated QC testing; removal of grout pipes after completion of tunneling, subsurface investigation and testing prior to installation; installation, monitoring/recording, maintenance and removal upon completion of surface monitoring points/arrays, deep settlement monitoring points, inclinometers and all related equipment*

## Measurement and Payment

*and/or software; steel joint rings on reinforced concrete pipe; automated spoil transportation systems; hoists; fluids and slurries; signal systems, safety equipment; protective joint seals/wraps; sealing materials, joint cushions, reaction thrust blocks, grout, sand, casings, skids and end seals as approved by the Construction Project Manager; filling of all annular spaces after completion of tunnel installation via contact grouting; steel casing pipe and welding to create water tight joints and any other necessary labor, equipment and materials; purchase, delivery and installation of all equipment and materials required to install the pipe segment and/or associated casing per the Contract Documents; heating and butt fusion jointing; within pit locations: removal and replacement of existing waterlines, valves, hydrants, vaults, restraints, sod, seeding, sprinkler systems, trees, bushes, shrubs, bike path, curb, gutter, sidewalk, pavement, asphalt base course, asphalt wearing surface, and any other surface restoration and/or removal/replacement required within the areas impacted due to these operations.*

---

### **34-12.1 4' Diameter Precast Manhole**

### **34-12.2 5' Diameter Precast Manhole**

### **34-12.3 6' Diameter Precast Manhole**

The measurement and payment for manholes shall be the total number of individual manholes, complete, in place required for construction of the proposed sewer and /or appurtenances.

*The unit price bid per manhole structure shall include all of the Contractor's costs of whatsoever nature. The price bid shall include: furnishing, transporting and installation of all materials, excavation including overexcavation to remove unsuitable foundation material and replacement with suitable material; sheeting and/or bracing; forming; cast-in-place or precast bases; concrete; steel reinforcement; precast barrel sections, flat tops and cones; brick, mortar, plastic joint sealant and grout; manhole steps, rings, cover, cast iron riser rings as specified by the Construction Project Manager; construction and shaping of the manhole base invert as shown in the standard details, and to incorporate lateral connections and flows into the main channel; water stop gaskets, all boots and bands; cutting and plugging of existing sewer lines as required; reconnection of existing lateral sewer lines to new structure as required, including pipe, couplings and all other materials, equipment and labor required to complete proper reconnection; core drilling into structure as necessary; construction of stub-outs or block-outs; elimination of infiltration; removal and replacement of pavement, base course, sub-base material, sod and other surfacing materials; backfill and compaction; and all other related and necessary materials, work and equipment required to construct the manholes, complete in accordance with the Contract Documents.*

---

### **34-12.4 Type B Manhole**

### **34-12.5 Type P Manhole**

### **34-12.6 Outfall Structure**

### **34-12.7 Special Structure**

The measurement and payment for cast in place manholes and/or structures shall be the total number of manholes or structures, complete, in place, required for construction of the proposed sewer and/or appurtenances.

*The unit price bid per manhole and/or structure shall include all of the Contractor's costs of whatsoever nature. The price bid shall include: furnishing, transporting and installation of all materials, excavation (including overexcavation to remove unsuitable foundation material and replacement with suitable material); sheeting and/or bracing; forming; concrete; providing high*

# Measurement and Payment

*early concrete as necessary to meet specific project needs; concrete additives including, but not limited to; set retarders, accelerators and polypropylene fibrillated fibers as directed and approved by Construction Project Manager; steel reinforcement; precast barrel sections, flat tops and cones; brick, mortar, plastic joint sealant and grout; manhole rings, covers and cast iron riser rings as specified by the Construction Project Manager; construction and shaping of the manhole base invert as shown in the Standard Construction Specifications, and to incorporate lateral connections and flows into the main channel; beveling and shaping of entrance/exit as required; cutting and plugging of existing sewer lines as required; reconnection of existing lateral sewer lines to new structure as required, including pipe, couplings and all other materials, equipment and labor required to complete proper reconnection; core drilling into structure as necessary; construction of stub-outs or block-outs; construction of waterproof joints; installation of water stop gaskets, boots and bands; elimination of infiltration; removal and replacement of pavement, base course, sub-base material, sod, decorative landscaping and other surfacing materials; backfill and compaction; and all other related and necessary materials, work and equipment required to construct the manholes and/or structures, complete, in accordance with the Contract Documents.*

---

## **34-12.8 Uncover and Raise (Adjust) Manhole**

The measurement and payment for this item will be the number of vertical linear feet of manhole height required to be located, uncovered, and raised for construction of the proposed sewer and/or appurtenances as required in the Contract Documents, by the Construction Project Manager or as determined via video inspection. Payment will be based upon completion of the work to a manner satisfactory to the Construction Project Manager and in accordance with the Contract Documents. No measurement for payment will be made for manhole adjustments required due to negligence or unauthorized operations by the Contractor.

*The unit bid for completion of this item shall include all of the Contractor's costs of whatsoever nature. The price bid shall include: locating, including electronic sensing if needed; excavation and overexcavation; removal and disposal of unsuitable material and excess excavated materials; backfill with approved materials; compaction; furnishing and transporting of all materials and equipment; cutting or adjusting of the manhole in a manner satisfactory to the Construction Project Manager; furnishing and placement of concrete, brick, mortar, concrete risers, concrete barrels, flat tops, cones, rings, covers, cast iron risers, plastic joint sealant, grout, manhole steps and all other related and necessary materials, work and equipment required to adjust manholes in accordance with the Contract Documents.*

---

## **34-12.9 Adjust Utility Lids**

The measurement and payment for this item will be the number of utility lids including but not limited to fiber optic, telecommunications, pull boxes, valve boxes, electrical vaults, water vaults, utility manhole lids, etc. required to be uncovered, raised and adjusted to final grade for construction of the proposed sewer and/or appurtenances as required in the Contract Documents, or as required by the Construction Project Manager. Payment will be based upon completion of the work to a manner satisfactory to the Construction Project Manager and in accordance with the Contract Documents. No measurement for payment will be made for utility lid adjustments required due to negligence or unauthorized operations by the Contractor.

*The unit bid for completion of this item shall include all of the Contractor's costs of whatsoever nature. The price bid shall include: locating, including electronic sensing if needed; excavation*

## Measurement and Payment

*and overexcavation; removal and disposal of unsuitable material and excess excavated materials; backfill with approved materials; compaction; furnishing and transporting of all materials and equipment; cutting or adjusting of the utility lid in a manner satisfactory to the Construction Project Manager; furnishing and placement of concrete, brick, mortar, concrete and/or cast iron risers, concrete barrels, flat tops, cones, rings, covers, grout, joint sealants, and all other related and necessary materials, work and equipment required to adjust utility lids in accordance with the Contract Documents.*

---

### **34-13.1 Pipe Outside Drop**

The measurement for payment of this item will be the total number of outside sanitary drops of the specified diameter required for construction of the proposed sewer facilities; provided, however, no measurement for payment will be made for outside drops not approved by the Construction Project Manager.

*The unit price bid per outside drop shall include all of the Contractor's costs of whatsoever nature. The price bid shall include: pipe and fittings, including additional pipe and/or materials necessary to connect the existing sewer to drop; concrete encasement and reinforcement; excavation and backfill; trench supporting; reshaping of inverts and benches to the top of the highest incoming pipe; reconnection of sidelines; forming and steel reinforcement; and all other related and necessary materials, work and equipment required to construct the outside drop in accordance with the Contract Documents.*

---

### **34-14.1 RCP Precast Bend**

### **34-14.3 RCP Flared End Section with Trash Rack**

### **34-14.4 Concrete Collars**

### **34-14.5 Flap Gate/Storm Control**

The measurement for payment of each specific size or type of special fitting shall be the total number of fittings required for construction of the proposed sewer and/or appurtenances.

*The price bid per special fitting shall include all of the contractor's costs of whatsoever nature. The price bid shall include: furnishing, transporting and installing all pipe specials and materials; joints and jointing materials; fasteners and tie downs; pipe collars and closures; bolts, grout, mortar, O-rings, connecting bands; excavation and compaction; shoring and backfilling; removal and disposal of unsuitable material and construction debris; adaptable trash racks for flared end sections; flap gates, assembly and installation; and all other related and necessary materials, work and equipment required to furnish and install these items in accordance with the Contract Documents.*

---

### **34-15.1 Sewer Tap Location and Verification**

The measurement for payment of this item will be the actual number of sewer service connections (sewer taps) required to be located and determined to be active; provided, however, no payment will be made due to negligence or unauthorized operations by the Contractor and only those sections specifically authorized by the Construction Project Manager shall be measured for payment.

---



# Measurement and Payment

*The unit price bid for locating all sewer service connections and verification of active sewer taps shall include all of the Contractor's costs of whatsoever nature for the complete verification and location of each active sewer tap. The price bid shall include: providing 48 hours public notification in advance of the work, furnishing and setting up all equipment required for location and/or verification and digital video and written log documentation of active sewer taps; labor; energy supply required for all equipment; permits and fees; coordination with locators (IUG and/or related utility companies); advance coordination and planning with facility owner to ensure access to mainline sewer; location (vertically and horizontally) and verification of active and capped sewer taps by digging, vacuuming, sensing, electronic locators, televising, dye testing, smoke tracing, and/or any other means necessary to ensure tap location, verification and adequate elevation for connection to sewer main per the Contract Documents; excavation, backfill, compaction; temporary and/or permanent paving; removal and replacement of curb, gutter, sidewalk, sod, sprinkler lines, etc. damaged during location and verification; removal and disposal of unsuitable material and construction debris; and all other related and necessary materials, work, and equipment required to complete this item in accordance with the Contract Documents.*

---

## **34-15.2 Reconnect Sanitary Sewer Services (Open Cut)**

The measurement and payment for each service connection, reconnection and/or adjustment shall be the total number of connections, reconnections and/or adjustments required for construction of the proposed sewer and/or appurtenance.

*The price bid for this item of work shall include all of the Contractor's costs of whatsoever nature. The price bid shall include; locating and verifying of service connections unless provided for elsewhere in the Contract Documents; furnishing and installing all pipe, fittings and materials; disconnecting/reconnecting and plugging existing services; plugging all necessary lines; construction of new services from mainline sewer to a point where proper connection and drainage can be achieved; chasing sewer taps from point of crossing or conflict with mainline to a point where proper relocation/reconnection can be attained; removal and replacement of sod, curb, gutter, and pavement outside mainline trench extents and all other surface items within affected areas; crossing of existing and abandoned facilities; excavation and backfill; bedding and compaction; temporary bypass pumping; extension of building sewers where required; loading, hauling and disposal of construction debris, excess excavated material, and contaminated materials at the Denver Arapahoe Disposal Site (DADS); and all other related and necessary materials, work, and equipment required to construct the service connection or reconnection in accordance with the Contract Documents.*

---

## **34-15.3 Utility Exploratory Investigation**

The measurement for payment of this item will be the actual number of field locations or verifications required for construction of the proposed sewer and/or appurtenances as required in the Contract Documents, or as directed by the Construction Project Manager.

*The unit price bid per location or verification shall include all of the Contractor's costs of whatsoever nature. The price bid shall include: mobilization and furnishing of all equipment required for location or verification of storm, sanitary or any other utility; acquisition of all permits; coordinating and scheduling the work with appropriate locating entities; coordination of this component of the work in a manner that ensures completion of the overall project per the critical path schedule and in accordance with the contract documents, excavation and backfill, including Controlled Low Strength Materials as required; paving, patching and*

## Measurement and Payment

*compaction; location of the utility by digging, vacuuming, sensing, or employment of other methods in utility location and/or verification; and all other related and necessary materials, work, and equipment required for location or verification of the sewer or utility as required in the Contract Documents or as directed by the Construction Project Manager.*

---

### **34-16.1 #14 Inlet**

### **34-16.2 Single #16 Inlet**

### **34-16.3 Double #16 Inlet**

### **34-16.4 Triple #16 Inlet**

### **34-16.5 Parking Lot Trench Drain**

The measurement for payment of each specific size and/or type of inlet will be the individual structure, complete, in place in accordance with the Contract Documents.

*The unit price bid per inlet structure shall include all of the Contractor's costs of whatsoever nature. The price bid shall include: furnishing, transporting, and installing all materials; excavation, including overexcavation to remove unsuitable foundation materials; concrete, pipe collars, reinforcement steel, mortar and grout; manhole lids, rings, covers, grates, frames and curb boxes; open throat construction; galvanized steel rods; manhole steps; concrete ribbed deflectors; backfilling and compaction; removal and replacement of pavement, base course, sub-base materials, sod, decorative landscaping and any other surfacing materials; constructing and shaping of the base and invert; replacement of curb, gutter and sidewalk between the transitions as stipulated on the Details; and all other related and necessary materials, work, and equipment required to construct the storm inlet in accordance with the Contract Documents.*

---

### **34-16.8 Adjust Existing Inlet Structure**

The measurement and payment for this bid item will be the actual number of existing inlet structures (excluding flagstone curb head) adjusted. Payment will be based upon completion of the work to a manner satisfactory to the Construction Project Manager and in accordance with the Contract Documents. No measurement for payment will be made for existing inlet structure adjustments due to negligence or unauthorized operations by the Contractor.

*The unit price bid will be the actual number of existing inlet structures (Inlet Grates, Frames, Beams, Curb Boxes, etc.), excluding flagstone curb head, adjusted. The unit price bid will include but shall not be limited to: mobilization; raising, lowering, moving, adding and/or removing of concrete, masonry, brick, mortar, concrete risers, inlet grates, plastic joint sealant, grout and all other related and necessary materials, work and equipment required to adjust inlet structures in accordance with the Contract Document; resetting of grates; replacement of curb, gutter and sidewalk between the inlet transitions as stipulated in the Details; traffic control; surface preparation and compaction as necessary; obtaining of a street occupancy permits and street cut permits; locating, including electronic sensing if needed; removal and disposal of construction debris; furnishing and transporting of all materials and equipment; and all other related and necessary materials, work and equipment required for the adjustment of the existing inlet structure.*

# Measurement and Payment

---

## **34-17.1 Pre-Video Inspection of Sewer Pipe**

## **34-17.2 Cleaning of Sanitary Sewer Pipe**

## **34-18.2 Cleaning of Storm Sewer Pipe**

The measurement for payment of this item will be the actual number of linear feet of sewer line cleaned and/or pre-video inspected and documented on the log sheet as measured along the centerline of the pipe from center of manhole to center of manhole with deductions made for the diameter of structures and appurtenances. Only those sections specifically authorized by the Construction Project Manager or noted in the Contract Documents will be measured for payment.

*The unit price bid per linear foot of sewer line cleaning and/or pre-video inspection shall include all of the Contractor's costs of whatsoever nature. The price bid shall include: providing 48 hours public notification in advance of the work furnishing and setting up of all equipment, labor, and materials necessary to clean and perform pre-video inspection of the sewer, including an intrinsically safe camera, as necessary; recording all information on USB Plug and Play device (flash drive or hard drive) for review by City; submittal of video in MP4 format and logs in .pdf format, both of which must be submitted in accordance to the naming convention required within the applicable Standard Construction specification section; Identification and locating of all active and inactive (capped) sewer taps, to include linear footage from center upstream manhole, by dye testing, electronic sensing, smoke tracing or use of any other means necessary to verify the active taps; determination of taps requiring trimming; locating, identifying and reporting structurally deficient pipe sections for replacement or point repair; completion of additional pre-installation inspections and sewer cleaning as necessary prior to CIPP installation; supply energy for all equipment; obtain permits for the inspection and covering any related fees; furnishing and setting up all equipment and labor necessary to clean the sewer; furnishing of water for jetting; removal of all foreign material from the sewer line that will prevent installation of cured in place products; all inspection and cleaning of manholes; by-pass pumping and/or diversion of sewer flows around the section of pipe to be cleaned and to another sewer line accepted by the Construction Project Manager to receive such bypass; temporary installation of bypass piping under the pavement of cross streets, or raised transitional crossings as may be required per the approved traffic control plan; repaving of street cuts after completion of bypassing; removal and replacement of manhole rings, covers, steps and cone sections as necessary to permit bypassing; storage of cleaning sediment on the job site in containers or other approved methods; maintaining storage during the waiting time for laboratory test results on the sediment; disposal of sediment according to Local, Federal, and State environmental requirements; removal and disposal of unsuitable material and construction debris; and all other related and necessary equipment, work, and materials required to accomplish this item in accordance with the Contract Documents.*

---

## **34-17.3 Sanitary Sewer By-Pass**

## **34-18.3 Storm Sewer By-Pass**

The measurement for payment of this item will be the number of linear feet of sewer line as measured along the centerline of the pipe run, where the work (ie: lining, repairing or replacing) is occurring from center of upstream manhole to center of downstream manhole and shall only be paid for once during the time necessary to complete each section of work. Bypass plans shall be submitted by the Contractor to the Construction Project Manager for review and shall include written by-pass pumping plans on the approved MHT map for the proposed bypass pumping segment, including plans for contingency activities in the event of weather changes,

## Measurement and Payment

equipment malfunction, or other disruptions. Bypass plans shall include providing a 48 hour public notification in advance of the work. Only those sections specifically identified within the contract documents or authorized by the Construction Project Manager will be bypassed and measured for payment. All by-pass activities will be performed using materials and methods that result in a complete system that provides zero leakage during all components of by-pass operations.

*The unit price bid per linear foot for this item shall include all of the Contractor's costs of whatsoever nature. The price bid shall include: furnishing and setting up of all equipment, labor, measurement and determination of sewer flow, all materials required to pump or divert sewer flows around the section of pipe or manhole being lined, repaired, reconstructed, or constructed to another sewer line accepted by the Construction Project Manager to receive such bypass; supplying of energy required to operate all bypass equipment; temporary installation of bypass piping under the pavement of cross streets, or raised transitional crossings as may be required per the approved traffic control plan; repaving of streets after completion of bypassing; removal and replacement of manhole rings, covers, steps and cone sections as necessary to permit bypassing; cleanup and removal of unsuitable material; and all other related and necessary equipment, work, and materials required to complete the bypassing as required in the Contract Documents or as directed by the Construction Project Manager.*

---

### 34-17.4 Cured-in-Place-Pipe

The measurement for payment of this item will be the actual number of linear feet of cured-in-place pipe installed, measured along the centerline of the pipe from center of manhole to center of manhole. Only those sections specifically authorized by the Project Manager or noted in the Contract Documents will be measured for payment.

*The unit price bid per linear foot of the Cured-In-Place-Pipe shall include all of the Contractor's costs of whatsoever nature. The price bid shall include, but is not limited to: providing 48 hours public notification in advance of the work, furnishing all equipment, materials, and labor necessary to complete CIPP installation; furnishing and setting up of all equipment, labor, and materials required to pump or divert sewer flows around the section of pipe being lined to another sewer line accepted by the Construction Project Manager to receive such bypass; supplying of energy required to operate all bypass equipment; temporary installation of bypass piping under the pavement of cross streets, or raised transitional crossings as may be required per the approved traffic control plan; repaving of streets after completion of bypassing; removal and replacement of manhole rings, covers, steps and cone sections as necessary to permit bypassing; cleanup and removal of unsuitable material; all other related and necessary materials, work, and equipment required to complete by pass; post-installation inspection video and engineering inspections of the sewer being rehabilitated; use of intrinsically safe equipment as necessary; recording all information on USB Plug and Play device (flash drive or hard drive) for review by City; submittal of video in MP4 format and logs in .pdf format, both of which must be submitted in accordance to the naming convention required within the applicable Standard Construction specification section; Identification and locating of all active and inactive (capped) sewer taps, to include linear footage from center upstream manhole, by dye testing, electronic sensing, smoke tracing or use of any other means necessary to verify the active taps; completion and submittal of written logs and digital as-constructed drawings; determination of taps requiring trimming; locating, identifying and reporting structurally deficient pipe sections for replacement or point repair, completion of additional pre-installation inspections and sewer cleaning as necessary prior to CIPP installation; supply energy for all equipment; obtain all*

## Measurement and Payment

*required permits for CIPP installation, materials used, the inspection and covering any related fees; furnishing and setting up all equipment and labor necessary to: clean the sewer; furnish water for jetting, perform bypass pumping required to install product; providing power for de-rooting equipment and other types of machinery; removal and disposal of all foreign material from the sewer line that will prevent installation of cured in place linings; storage of cleaning sediment on the job site in containers or other approved methods; maintaining storage during the waiting time for laboratory test results on the sediment; disposal of sediment according to Local, Federal, and State environmental requirements; all public information and notifications; attending the weekly construction meeting and any other meeting required by the Project Manager; all inspection and cleaning of manholes; removal and disposal of unsuitable material and construction debris; furnishing and setting up all equipment, materials, and labor necessary for the construction process; furnishing water, steam and energy required for the rehabilitation process; furnishing, installing and applying the Cured-In-Place-Pipe Material; curing the CIPP liner, cutting, trimming and brushing active sewer service connection; hydrophilic water swelling material as needed to prevent infiltration between the CIPP liner and host pipe at each manhole; providing access to the City and County of Denver, or their designee, for the purpose of obtaining samples of installed material for onsite and laboratory testing; incidentals referenced in other sections of the Specifications; and all other related and necessary materials, work, and equipment required to complete this item in accordance with the Contract Documents.*

---

### 34-17.5 Grinding

The measurement for payment of this item will be the actual number of linear feet of grinding within the sewer line submitted and approved by the Project Manager.

It shall be the Contractor's responsibility to notify the Project Manager of pipe segments that require grinding to facilitate CIPP installation. Only those sections specifically designated by the Construction Project Manager will be ground and measured for payment. Measurement shall commence at the point at which the obstruction is encountered and terminate the point at which the obstruction is removed. Payment for grinding will not be made due to negligence or unauthorized operations by the Contractor.

*The unit price bid per linear feet of sewer line grinding shall include all of the Contractor's costs of whatsoever nature. The price bid shall include: providing 48 hours public notification in advance of the work, providing pre and post digital verification video of the specific pipe segments proposed for grinding, removal of roots, protruding objects, chemical deposits, unsuitable material or any other materials as directed by the Construction Project Manager prior to placement of any liner; grinding via mechanical, chemical or other approved methods; furnishing and setting up of all equipment and labor necessary to inspect the line to be rehabilitated; video inspection of the line to locate and identify live sewer taps and to locate taps that require trimming; recording of the video inspection; removal of all materials from the pipe walls that will prevent the proper installation of cured-in-place or formed-in-place plastic liners; furnishing of water and power for de-rooting equipment; storing of cleaning sediments on the job site in containers or other Federal or locally approved storage methods; maintaining of stored materials during the time required to obtain laboratory tests; transporting of the sediment for disposal to a landfill upon receipt of laboratory tests results showing that all tests meet Federal and local standards for normal disposal, payment of disposal and landfill fees, if the material is being hauled to any site other than Denver/Arapahoe Disposal Site (DADS); cleaning and inspection of manholes; and all other related and necessary materials, work and equipment required to complete this item in accordance with the Contract Documents.*

# Measurement and Payment

---

## **34-17.6a Sanitary Sewer Service Reactivation for CIPP**

### **34-17.6b Storm Sewer Service Reactivation for CIPP**

The measurement for payment of this item will be the actual number of sewer service taps required to be reactivated as determined to be active during the pre-video inspection study. No measurement for payment will be made for taps which are opened/reactivated and have not been determined to be active. The Contractor shall accept all responsibility to provide residents, businesses, etc. with an established and reconnected sewer service. No measurement will be made for sewer service reactivations due to negligent or unauthorized operations by the Contractor.

*The unit price bid shall include all of the Contractor's costs of whatsoever nature. The price bid shall include: furnishing and setting up of all equipment and labor necessary to locate and reactivate active services; cutting and brushing of CIPP material and linings, coatings and/or coverings required to open active sewer services; removal and disposal of all unsuitable material; providing 48 hours public notification in advance of the work and notifying residents and business upon reactivation; and all other related and necessary materials, work and equipment required to complete this item in accordance with the Contract Documents or at the direction of the Construction Project Manager.*

---

### **34-17.7 Extended Tap Cutting**

The measurement and payment for this item will be the actual number of submitted and approved extended taps or services that would have to be cut or otherwise repaired for construction of the proposed sewer and or appurtenances. No measurement will be made for extended tap cutting required due to negligent or unauthorized operations by the Contractor.

*The unit price bid shall include all of the Contractor's costs of whatsoever nature. The price bid shall include: furnishing of all equipment and labor required to cut the extended tap; cutting of the tap to a smooth and hydraulically functional opening; furnishing of power for all equipment; video-inspection and locating of the extended tap; removal and disposal of materials; and all other related and necessary materials, work and equipment required to complete this item in accordance with the Contract Documents or at the direction of the Construction Project Manager.*

---

### **34-17.8 Intrinsically Safe Electrical Equipment**

No measurement for payment will be made for any of the work and materials required to accomplish this aspect of the construction project and payment will be based upon the completion of the work in accordance with the Contract Documents.

The areas/extents within the Contract Documents requiring the use of explosion proof equipment shall be determined by the Contractor. Damage and repair to the sanitary system and surrounding areas due to misuse of equipment, faulty equipment or negligence are the responsibility of the Contractor.

*The lump sum price bid for Intrinsically Safe Electrical Equipment shall include all of the Contractor's costs of whatsoever nature. The lump sum price bid shall include: furnishing, installing, and activating the camera; all labor of whatsoever nature to the various areas of construction, and all other related and necessary materials, work, and equipment required to accomplish this item in a manner satisfactory to the Construction Project Manager and in accordance with the Contract Documents.*

---

# Measurement and Payment

---

## **36-1 Install Railroad Tracks**

The measurement for payment of this item will be the actual number of linear feet of railroad tracks constructed, including appurtenances, as shown within the contract documents; provided, however, no payment will be made for track installation outside the project limits or for track installation due to negligence or unauthorized operations by the Contractor. Payment will be based upon each pair of tracks constructed, as measured along the centerline of the newly installed tracks.

*The unit price bid per pair of railroad tracks shall include all of the Contractor's costs of whatsoever nature. The linear foot price bid per pair of railroad tracks shall include: all work and materials required to install the tracks per the Governing Railroad Company, contract documents and design criteria; procurement, including protection and stockpiling of materials removed and approved for re-use, hauling, delivery and installation of ballast; track hardening; railroad ties; pre-stressed concrete panels; full depth asphalt or concrete paving up to the concrete panels as delineated by the area perpendicular to the length of tracks being replaced and within 25 feet of the centerline of the tracks on each side; joining of rails; fasteners, spikes, special joints; grading the subgrade and special bedding under the tracks; hauling and disposal of all excavated material which is not recyclable to the Denver Arapahoe Disposal site; backfilling and compaction; and all other related and necessary materials, work and equipment required for the installation of this item in accordance with the Contract Documents.*

---

## **40-1 Seeding and Mulching**

The measurement and payment for this item will be the total number of square feet of seed, mulch and required soil amendment placed for construction of the proposed sewer and or appurtenances; however, no measurement will be made for seed and mulch placed due to negligent or unauthorized operations by the Contractor.

*The unit price bid per square foot of seed and mulch placed shall include all of the Contractor's costs of whatsoever nature. The price bid shall include: furnishing, transporting and placing of seed, mulch, erosion control fabric, blankets or protective coverings; protection and care of stockpiled seed and mulch; preparation, fertilization and soil amendment; furnishing of new seed and mulch of like quality to replace any improperly maintained seed and mulch; watering, raking and rolling the ground surface after placement of seed and mulch; placement of erosion blanket on all slopes greater than 3:1; and all other related and necessary materials, work and equipment required to furnish and place the seed and mulch, complete, in accordance with the Contract Documents.*

---

## **40-2 Seeding**

The measurement and payment for this item will be the total number of square feet of seed to be placed for construction of the proposed sewer and/or appurtenances; however, no measurement for payment will be made for seeding required due to negligent or unauthorized operations by the Contractor.

*The unit per square foot of seed placed shall include all of the Contractor's costs of whatsoever nature. The price bid shall include: preparation of soils, ripping and tilling, cleaning, fertilization, leveling to the elevations specified in the Contract Documents; furnishing of seed as specified in the Contract Documents; placing of the seed, wetting, and compaction; erosion control fabric,*

---

# Measurement and Payment

*blankets, or protective coverings as required; watering; reseeding and/or replacement of any improperly maintained seed; and all other related and necessary materials, work, and equipment required to place the seed in accordance with the Contract Documents.*

---

## **40-3 Sodding**

The measurement and payment for this item will be the total number of square feet of sod required to be placed for construction of the proposed sewer and/or appurtenances; provided, however no measurement will be made for sod placed due to negligent or unauthorized operations by the Contractor.

*The unit price bid per square foot shall include all of the Contractor's costs of whatsoever nature. The price bid shall include: preparation and cleaning of the ground surface; furnishing of sod as specified in the Contract Documents or to the same quality as the existing sod; replacement of any improperly maintained sod; proper placement of the sod; watering, rolling and compaction; clean up and disposal of unsuitable material; and all other related and necessary materials, work and equipment required to place the sod in accordance with the Contract Documents.*

---

## **40-4a Install Sprinkler Line**

### **40-4b Relocate Existing Sprinkler Line**

The measurement and payment for this item will be the total number of linear feet of sprinkler line required to be installed or relocated for construction of the proposed sewer and/or appurtenances; provided, however no measurement will be made for sprinkler placed due to negligent or unauthorized operations by the Contractor.

*The unit price bid shall include all of the Contractor's costs of whatsoever nature. The price bid shall include: excavation, furnishing of materials, protection and installing pipework and heads; adjusting heads; fittings and connections; backfilling, grading, installing and adjusting valves; and all other related and necessary materials, work, and equipment required to install the sprinkler system in accordance with the Contract Documents or as directed by the Construction Project Manager.*

---

## **40-5 Install or Relocate Sprinkler System**

No quantity measurement will be made for any of the work and materials required to install and/or relocate sprinkler systems. Payment will be based upon completion of the work in accordance with the Contract Documents; provided, however, no payment will be made for installing and/or relocating sprinkler systems due to negligent or unauthorized operations by the Contractor.

*The lump sum bid price shall include all of the Contractor's costs of whatsoever nature. The price bid shall include: excavation, furnishing and installation of all sprinkler system materials and materials necessary for relocation of an existing system; protection and installing pipework and heads; adjusting heads; fittings and connections; backfilling, grading, installing and adjusting valves; trace wires; electrical hookups, valve boxes and controls; pressure testing of system; winterization and recharging of system as necessary during project period of performance; and all other related and necessary materials, work, and equipment required to install and/or relocate the sprinkler system in accordance with the Contract Documents or as directed by the Construction Project Manager.*

---



# Measurement and Payment

---

## **40-6 Decorative Landscaping**

No quantity measurement will be made for any of the work and materials required to remove and replace this item. Payment will be based upon completion of the work in accordance with the Contract Documents; provided, however, no payment will be made for removing and replacing decorative landscaping required to be replaced due to negligent or unauthorized operations by the Contractor.

*The lump sum bid price shall include all of the Contractor's costs of whatsoever nature. The price bid shall include: excavation; removal and replacement of concrete, rock; removal and replacement of plants, mulch, support systems and retaining structures; disposal of excess excavated materials; topsoil, fertilizer, water, storage and all other related and necessary materials, work and equipment, required to replace the decorative landscaping in accordance with the Contract Documents.*

---

## **40-7 Remove Trees (>6" Diameter)**

### **40-8 Remove Bushes**

The measurement for payment of this item will be the total number of trees, bushes, shrubs or landscaping units, required to be removed for construction of the proposed sewer as specified in the Contract Documents and directed by the Construction Project Manager; provided, however, no measurement for payment will be made for items removed which are less than six (6) inches in diameter at a height of one (1) foot above the existing ground.

*The unit price bid per tree, bush, shrub or specified landscaping item removal shall include all of the Contractor's costs of whatsoever nature. The price bid shall include: removal of a sufficient length of the root system to insure that the tree, bush, shrub or landscaping unit will not continue to grow; disposal of all materials removed; acquisition of all permits required for removal; backfilling with soil material approved by the Construction Project Manager; and all other related and necessary materials, work and equipment required to remove trees in accordance with the Contract Documents.*

---

## **40-9 Remove and Transplant Trees (>6" Diameter)**

### **40-10 Replace Bushes and/or Shrubs**

The measurement for payment of this item will be the total number of trees required to be removed and transplanted and/or the total number of shrubs and/or bushes required to be replaced for construction of the proposed sewer; provided, however, no measurement for payment will be made for trees required to be removed and transplanted, or shrubs and/or bushes required to be replaced due to negligent or unauthorized operations by the Contractor.

*The unit price bid per tree removal and transplant or shrub and/or bush replacement shall include all of the Contractor's costs of whatsoever nature. The price bid shall include: removal, storing, planting, replanting or replacing, puddling, backfilling, and all other related and necessary materials, work and equipment required to remove and transplant the tree or replace the shrub and/or bush in accordance with the Contract Documents.*

---

## **40-11 Replace Green Ash Tree (2" Caliper)**

### **40-12 Replace Tree (>6" Diameter)**

# Measurement and Payment

The measurement for payment for tree planting or replanting will be the total number of trees required to be placed per plans and due to construction of the proposed sewer; provided, however, no measurement for payment will be made for trees planted due to negligent or unauthorized operations by the Contractor.

*The unit price bid per tree placement or replacement shall include all of the Contractor's costs of whatsoever nature. The price bid shall include: removal, storing, replanting or replacing, backfilling, staking and supporting devices; formed wells and/or cages; insulating wrap; protection from animals; watering and care throughout the warranty period; and all other related and necessary materials, work and equipment required to plant and replant the tree in accordance with the Contract Documents.*

---

## **40-13 Shade Trees (> 2" Caliper)**

### **40-14 Ornamental Trees (> 2" Caliper)**

The measurement for payment for tree planting will be the total number of trees required to be placed per plans and due to construction of the work; provided, however, no measurement for payment will be made for trees planted due to negligent or unauthorized operations by the Contractor.

*The unit price bid per tree placement shall include all of the Contractor's costs of whatsoever nature. The price bid shall include: delivery, temporary protection, storage, planting, backfilling, staking and temporary support devices; formed wells and/or cages; insulating wrap; protection from animals; watering and care throughout the warranty period; and all other related and necessary materials, work and equipment required to plant the tree in accordance with the Contract Documents.*

---

## **40-15 Landscape Improvements**

No quantity measurement will be made for any of the work and materials required for this item in construction of the proposed landscape and irrigation improvements. Payment will be based upon completion of the work in accordance with the Contract Documents; provided, however, no payment will be made for any work performed due to negligent or unauthorized operations by the Contractor.

*The lump sum bid price shall include all of the Contractor's costs of whatsoever nature. The price bid shall include all of the work and equipment, and all other related and necessary materials, required to construct all of the proposed landscape and irrigation improvements shown on the landscape/irrigation plans, in accordance with the Contract Documents.*

---

## **41-1 Traffic Control**

No quantity measurement will be made for any of the work and materials required to accomplish this aspect of the construction project and payment will be based upon the completion of the work in accordance with the Contract Documents.

*The lump sum price for Traffic Control shall include all of the Contractor's costs of whatsoever nature. The lump sum bid price shall include: All coordination with relevant agencies and utility companies; including by-pass pumping plans on the MHT plans submitted to City and County of Denver- Public Works Right of Way Services; furnishing, installing, moving, maintaining and removing all temporary traffic signs, barricades, channeling devices, warning lights, delineators, and any other equipment or personnel as required by the latest revision of the "Manual on*

# Measurement and Payment

*Uniform Traffic Control Devices for Streets and Highways”, and the requirements set forth by the City and County of Denver, Transportation Engineering Division; all signs, emergency replacements, warning lights, variable message boards, traffic cones, and barricades; approved traffic maintenance plans as required; concrete median barriers as required; lane markings and temporary striping; flagging and notification of property owners; traffic control management; furnishing, installing, adjusting, maintaining and removing all special signs required to direct pedestrians and/or vehicles to businesses or parking facilities disrupted due to construction activities; additional traffic control and safety devices as required by the Construction Project Manager; and all other related and necessary materials, work, and equipment required to accomplish this item in accordance with the Contract Documents.*

*At the option of the Construction Project Manager payment will be made in percentage installments based upon type, location and scope of work in relation to the period of performance.*

---

## **41-2 Rerouting and Construction of Bike Path**

No quantity measurement will be made for any of the work and materials required to accomplish this aspect of the construction project and payment will be based upon the completion of the work in accordance with the Contract Documents.

*The lump sum price bid for rerouting and construction of bike paths shall include all of the Contractor’s costs of whatsoever nature. The price bid shall include: furnishing, installing, moving, maintaining and removing all temporary traffic signs, barricades, channelization devices, warning lights, delineators, bike path signage and any other equipment or personnel required for safe conductance and detouring of bike path personnel off and around the designated construction zone in a safe and professional manner; construction of safety fence, including placement of concrete barriers; coordination with Parks and/or Traffic personnel; obtaining of necessary permits and paying associated fees; water control; placement of rock or pavement for temporary bike path; and all other related and necessary materials, work, and equipment required to accomplish this item in accordance with the Contract Documents or the direction of the Construction Project Manager.*

*At the option of the Construction Project Manager, one third of the lump sum price for this item may be paid to the Contractor upon satisfactory completion of and/or incorporation of proper controls, the second third may be paid upon fifty percent completion of the work as determined by the percent of work completed on the day of progress payment, and the last third may be paid to the Contractor at the last progress payment or at the discretion of the Construction Project Manager.*

---

## **42-1 Railroad Control**

No measurement will be made for any of the work and materials required to accomplish this aspect of the construction project and payment will be based upon the percent completion of the work in accordance with the Contract Documents.

The City and County of Denver (railroad Licensee) will obtain all necessary license agreements. The contractor(agent of Licensee including subcontractors, officers, agents and employees; and others acting under the licensee or agent of licensee’s authority) will be responsible for the acquisition and maintenance of all railroad protective liability insurance as required by the railroad crossing agreements included within the bid document package, and which is deemed

## Measurement and Payment

necessary by the railroad to complete construction. In no way should the railroad pipeline crossing agreement be used to dictate railroad flagger/inspector participation in a project. Railroad Flagger/inspector participation shall be determined by local railroad officials.

*The lump sum price for Railroad Control shall include all of the Contractor's costs of whatsoever nature. The price bid shall include: acquisition of additional insurance required by the railroad company to work within railroad right-of-ways, or as otherwise noted within the license agreement; acquisition of all permits, payment of all railroad flagging, inspection and associated permit fees; detouring, railroad traffic control, as required; furnishing of approved base materials, as required to bring the subgrade up to ballast elevation; supplying materials required to protect railroad tracks for equipment crossing; adhering to the conditions of permits, easements, and railroad agreements; preparation of submittals required by the railroad and receipt of approvals prior to work, design and stamping by an Engineer licensed in the State of Colorado as necessary; notification of the railroad and the public of proposed work; arrangements with the railroad for use of railroad property not covered under permits, easements, or railroad agreements; coordination with the railroad and its sub tiers for removal and replacement of the track and its related facilities; railroad safety training for all personnel working within the railroad right-of-way; and all other related and necessary materials, work and equipment required to accomplish this item in accordance with Right of Entry Permits, Pipeline Crossing Agreements and adherence to the latest edition of the American Railway Engineering and Maintenance-of-Way Association (AREMA) Standards, the Contract Documents or as directed by the Construction Project Manager.*

*At the option of the Construction Project Manager, monthly percentage payments, based upon Period of Performance, may be paid to the contractor upon satisfactory completion of and/or proper controls submitted in monthly payment application, or at the discretion of the Construction Project Manager. Up to the last progress payment or at the discretion of the Construction Project Manager.*

---

### 43-1 Storm Water Management

No quantity measurement will be made for any of the work and materials required to accomplish this aspect of the construction project and payment will be based upon the completion of the work in accordance with the Contract Documents.

*The lump sum price for Storm Water Management shall include all of the Contractor's costs of whatsoever nature. The price bid shall include: implementing measures per Best Management Practices (BMPs); obtaining all permits and paying any associated fees (i.e. NPDES, etc.); coordination with State and Local agencies as required to setup all required plans for the project; furnishing, installing and removing erosion control materials required by the Contractor's plans; protection of existing flow lines, inlets and manholes; care and diversion of drainage courses; pumping and bypass pumping; construction and design of special erosion control plans for emergency situations that develop during construction or unexpected weather conditions; providing filter fabric, bales, stakes, rock, filter material, silt fence, gabions, wire mesh, temporary berms, temporary diversions, temporary slope drains, check dams, geotextile protection, sediment traps and basins; clearing and grubbing for placement of planned control features, etc.; flushing, jetting and/or removal of construction debris from existing systems as required by the Construction Project Manager; stabilization of the work area by seeding and/or mulching during and after construction; disposal of work materials; maintenance of all erosion control features and seeded areas, so they function properly during construction; testing of*

# Measurement and Payment

*sediment and disposal as required; and all other related and necessary materials, work and equipment required to accomplish this item in accordance with the Contract Documents.*

*At the option of the Construction Project Manager, one third of the lump sum price for this item may be paid to the Contractor upon satisfactory completion of and/or incorporation of proper controls, the second third may be paid upon fifty percent completion of the work as determined by the percent of work completed on the day of progress payment and the last third may be paid to the Contractor at the time of final progress payment or at the discretion of the Construction Project Manager.*

---

## **44-1 Dewatering**

No quantity measurement will be made for any of the work and materials required to accomplish this aspect of the construction project and payment will be based upon the completion of the work in accordance with the Contract Documents. This bid item is for dewatering to accomplish the work, however no payment will be made for dewatering due to failure to protect the excavation from storm events, failure to protect existing utilities or dewatering included elsewhere in these contract documents. No payment will be made for this lump sum item without specific written approval of the Construction Project Manager.

*The lump sum price for dewatering shall include all of the Contractor's costs of whatsoever nature. The price bid shall include: pumping and bypass pumping; furnishing of all equipment and manpower; furnishing and installing erosion control materials; obtaining all required discharge permits and paying associated fees; excavation, haul, backfill; installation of caissons, pump pits, piping and drainage courses; disposal of excess and contaminated water; water testing; and all other related and necessary materials, work and equipment required to accomplish this item in accordance with the Contract Documents.*

---

## **44-2 Water Treatment**

No quantity measurement will be made for any of the work and materials required to accomplish this aspect of the construction project and payment will be based upon the completion of the work in accordance with the Contract Documents

*The lump sum price for treatment of contaminated water shall include all of the Contractor's costs of whatsoever nature. The price bid shall include: pumping and bypass pumping; sampling and/or water testing; furnishing of all labor, equipment and materials for treatment of contaminated water on site; furnishing and installing of erosion control materials; obtaining all required discharge permits and paying of associated fees; installation of caissons, pumps, pump pits and drainage courses; disposal of excess and contaminated water; excavation, haul , backfill; and all other related and necessary materials and equipment required to accomplish this item in accordance with the Contract Documents. All work must proceed in a manner that does not delay the project*

---

## **45-1 CIPP Laboratory Testing**

The measurement for payment of this item will be the actual number of laboratory tests required for completion of this project and/or installation of related appurtenances.

# Measurement and Payment

*The unit price bid shall include all of the Contractor's costs of whatsoever nature. The price bid shall include: coordination with a third party tester, creating the sample, for third party transport to the testing lab; receipt of written results by the Construction Project Manager; testing of: final CIPP product, sediment removed from sewer line during cleaning, water quality, soils or other types of laboratory tests as required by the Construction Project Manager; tests shall determine materials composition, concentrations of chemicals, or contaminants present, Atterberg soils limits, soil stress, permeability, volatile organic compounds; testing of CIPP pipe as outlined in the Technical Specifications; and all other related and necessary materials, work and equipment required to complete this item in accordance with the Contract Documents and as directed by the Construction Project Manager.*

---

## **45-2 Quality Control Testing**

No quantity measurement will be made for any of the work and materials required to accomplish this aspect of the construction and payment will be based upon completion of the work in accordance with the Contract Documents. The lump sum price bid shall include the coordination and performance of quality control testing for all facets of the Work in accordance with the City's Frequency of Testing standards.

*The lump sum price for Quality Control Testing shall include all of the Contractor's costs of whatsoever nature. The price bid shall include: procurement and payment of professional services; testing of: soils, asphalt, concrete and any materials incorporated into the work (bedding, controlled low strength materials, select or imported fill, etc.) in accordance with the Contract Documents; all testing associated with any form of grouting, as specified in these contract documents; coordination and scheduling of testing; travel to and from work site; additional testing by the Contractor for its own use; re-testing of work components (backfill, concrete used in structures, etc.) as necessary to ensure conformance with Contract Documents, re-testing of work components due to failing QA test results by owner; delivery and transport to testing lab; furnishing of written results to the Construction Project Manager; and all other related and necessary materials, work and equipment required to complete this item in accordance with the Contract Documents and as directed by the Construction Project Manager.*

*At the option of the Construction Project Manager, one quarter of the lump sum price for quality control testing may be paid to the Contractor at the time of the first monthly progress payment, the second quarter may be paid at the time of the second monthly progress payment, and the third quarter may be paid to the Contractor at the time of the third monthly progress payment, or at the discretion of the Construction Project Manager. The total payment for this bid item shall not exceed seventy-five percent (75%) of the lump sum price during construction. The remaining twenty-five percent (25%) shall be paid after substantial completion of the work and only after all project testing and/or results have been completed and/or provided for project recordation. Any costs paid by the City which are the result of retesting previously failing QA events may be deducted from the Contractor's payment, as applicable and as determined by the Construction Project Manager.*

- 
- 46-1 Pavement Marking (Paint)**
  - 46-2 Epoxy Pavement Marking**
  - 46-3 Thermoplastic Pavement Marking**
  - 46-4 Preformed Plastic Pavement Marking**
  - 46-5 Pavement Marking Tape**

## Measurement and Payment

The measurement for payment of this item will be the actual square feet of pavement marking material or paint installed, as required to accomplish this aspect of the construction. Payment will be based upon completion of the work in accordance with the Contract Documents.

*The unit price square foot shall include all of the Contractor's costs of whatsoever nature. The price bid shall include: pavement marking plans when required; furnishing and installation of paint, marking tape, thermoplastic and methyl methacrylate materials; furnishing of all equipment required for application of all pavement marking materials; sandblasting and high pressure cleaning to remove all dirt, laitance, and curing compound residues; and all other related and necessary materials, work and equipment for pavement marking as required in the Contract Documents or as directed by the Construction Project Manager.*

---

### 47-1 Construction Surveying

No quantity measurement will be made for any of the work or materials required to accomplish this aspect of the construction project and payment will be based upon the completion of the work in accordance with the Contract Documents.

*The lump sum cost shall include all of the Contractor's cost of whatsoever nature. The price bid shall include: construction surveying and staking; boundary staking; re-staking as necessary during construction; maintenance and submittal of as-built records, red-lined drawings, final survey and recordation, and prints necessary for the creation of as-built documents for all elements of the project to the Construction Project Manager ; elevation/survey checks as requested by the City during construction; verification of all survey control points, City of Denver range points, section corners and benchmarks prior to starting work; submittal of required items to the City Survey per the specifications; traffic control required to perform work under this bid item; and all other related and necessary materials, work and equipment required to accomplish this item in accordance with the Contract Documents.*

All work performed within this bid item shall be done under the supervision of a Professional Land Surveyor (PLS) or Professional Engineer (PE) who is experienced and competent in storm sewer construction, sanitary sewer construction and roadway construction surveying and is licensed in the State of Colorado.

At the option of the Construction Project Manager, one quarter of the lump sum price for Construction Surveying may be paid to the Contractor at the time of the first monthly progress payment, the second quarter may be paid to the Contractor at the time of the second monthly progress payment, and the third quarter may be paid to the Contractor at the time of the third monthly progress payment, or at the discretion of the Construction Project Manager. The total payment for this bid item shall not exceed seventy-five percent (75%) of the lump sum price during construction. The remaining twenty-five percent (25%) shall be paid after submittal of final survey and recordation documents to the Construction Project Manager for creation of as-built drawings.

---

### 47-2 Survey Monumentation

The measurement and payment of this item will be the total number of survey monuments removed and replaced for construction of the proposed sewer and/or appurtenances as indicated within the contract documents; provided, however, no measurement for payment will be made for survey monumentation required due to careless or unauthorized operations

# Measurement and Payment

by the Contractor. No measurement will be made for locating survey monuments, preserving and referencing monuments within the project limits.

*The unit price bid shall include all of the Contractor's costs of whatsoever nature. The price bid shall include: record searches and research; locating, preserving, referencing, adjusting, installing and/or restoring survey monumentation as described within the contract documents; the preparation and depositing of monument tie-out sheets and final monumentation diagram; traffic control required to perform work under this bid item; construction survey checklists, equipment calibrations; monumentation related survey records; and all other related and necessary materials, work and equipment required to accomplish this item in accordance with the Contract Documents.*

All work performed within this bid item shall be done under the supervision of a Professional Land Surveyor (PLS) who is experienced and competent in storm sewer construction, sanitary sewer construction, roadway construction surveying, boundary surveying and is licensed in the State of Colorado.

---

## 50-1 Mobilization

No quantity measurement will be made for any of the work and materials required to accomplish this aspect of the construction project and payment will be based upon the completion of the work in accordance with the Contract Documents

*The lump sum cost shall include all of the Contractor's costs of whatsoever nature. The price bid shall include: mobilization and demobilization to the site or sites defined within the contract documents, multiple mobilizations and demobilizations to accommodate construction moratoriums, events, schools, and/or special circumstances outlined in the Contract Documents; transporting all equipment and materials; temporary sanitary facilities; complete setup, removal, repair, coordination and payment of fees associated with temporary staging facilities; project signs; obtaining groundwater discharge permits and all additional permits required by state and local agencies to complete any facet of the work; fugitive dust control in accordance with D.R.M.C. Title II Chapter 4 Sec. 4-25 throughout entire project duration, development of fugitive particulate control plans as required and street sweeping and site cleanup as necessary; loading, hauling and disposal of all construction related debris and excess excavated material not provided for elsewhere in the Contract Documents; advance coordination, notification and scheduling with City and County of Denver agencies, all affected utility companies, railroads, businesses, and homeowners; scheduling of work to accommodate residents, business owners and special circumstances encountered during construction and/or as indicated in the Contract Documents; all aspects of public information services as required with the Standard Construction Specifications for the project; night and weekend work as necessary; any labor of whatsoever nature required in various areas of construction site as necessary to complete the work in accordance with the Contract Documents. The contractor shall be responsible for all maintenance of parks facilities affected by construction activities. This includes, but is not limited to, the maintenance and irrigation of landscaping items outside of the work area which are disconnected from service due to construction operations. All cost for this work shall be included within this bid item and no additional payment will be made. At the option of the Construction Project Manager, payment may be made in percentage installments based upon type, location and scope of work in relation to the period of performance. . The total payment for this bid item shall not exceed seventy-five percent (75%) of the lump sum price during construction. The remaining twenty-five percent (25%) shall be paid after final site cleanup, completion of all punch list items and demobilization from site.*



# Measurement and Payment

---

## 50-1a Emergency Mobilization

No quantity measurement will be made for any of the work and materials required to accomplish this aspect of the construction and payment will be based upon the completion of the work in accordance with the Contract Documents. The required time for mobilization to site shall be five (5) hours from official written notification.

*The measurement for payment of this item will be the actual number of emergency mobilizations required to complete the work in accordance with the Contract Documents and shall include all of the Contractor's costs of whatsoever nature. Each individual site response officially requested by the Construction Project Manager shall be considered one emergency mobilization. The price bid shall include: emergency mobilization; demobilization; transporting all equipment and materials; temporary sanitary facilities; complete setup, removal, repair, coordination and payment of fees associated with temporary staging facilities; obtaining groundwater discharge permits and all additional permits required by state and local agencies to complete any facet of the work; fugitive dust control in accordance with D.R.M.C. Title II Chapter 4 Sec. 4-25 throughout entire project duration, development of fugitive particulate control plans as required and street sweeping and site cleanup as necessary; loading, hauling and disposal of all construction related debris and excess excavated material not provided for elsewhere in the Contract Documents; advance coordination, notification and scheduling with City and County of Denver agencies, all affected utility companies, railroads, businesses, and homeowners; scheduling of work to accommodate residents, business owners and special circumstances encountered during construction and/or as indicated in the Contract Documents; all aspects of public information services as required with the Standard Construction Specifications for the project; night and weekend work as necessary; any labor of whatsoever nature required in various areas of construction site as necessary to complete the work in accordance with the Contract Documents.*

**END OF MEASUREMENT AND PAYMENT**



# DENVER

## PUBLIC WORKS

CITY AND COUNTY OF DENVER  
ENGINEERING DIVISION

# Wastewater Capital Projects Management Standard Construction Specifications

March 15, 2016

---



CITY AND COUNTY OF DENVER  
ENGINEERING DIVISION

# Wastewater Capital Projects Management Standard Construction Specifications

---

## Table of Contents

<i>Section</i>	<i>Page</i>
1.0	Scope.....1-1
01-1416	Public Information Services .....011416-1
01-5213	Temporary Office Facilities .....015213-1
2.0	Site Preparation .....2-1
02-2213	Vibration Assessment .....022213-1
3.0	Existing Facilities .....3-1
4.0	Utility Trenching and Excavation .....4-1
5.0	Bedding and Backfilling.....5-1
6.0	Surface Restoration.....6-1
7.0	Pipe Jacking, Boring, Casing and Micro Tunneling
7.1	Tunneling, Jacking and Boring.....7.1-1
7.2	Micro Tunneling .....7.2-1
7.3	Shaft Excavation and Support .....7.3-1
7.4	Permeation Grouting.....7.4-1
7.5	Compensation Grouting .....7.5-1
8.0	Structural Excavation .....8-1
9.0	Testing, Inspection and Acceptance .....9-1
10.0	Storm/Sanitary Sewer Pipe and Culverts
10.1	Precast Concrete Pipe .....10.1-1
10.3	Precast Reinforced Box Conduits .....10.3-1
10.4	Reinforced Polymer Mortar Pipe .....10.4-1

10.5	Ductile Iron Pipe .....	10.5-1
10.6	Polyvinyl Chloride (PVC) Sewer Pipe .....	10.6-1
10.7	Cured In Place Pipe.....	10.7-1
10.20	Pipe Bursting.....	10.20-1
11.0	Structures and Appurtenances .....	11-1
12.0	Riprap Boulders and Slope/Channel Protection .....	12-1
13.0	Fencing.....	13-1
14.0	Removal and Disposal of Construction Debris and Contaminated Materials .....	14-1
15.0	Reserved	
20.0	Grass Sodding.....	20-1
21.0	Sprinkler Systems.....	21-1
22.0	Seeding.....	22-1
23.0	Storm Water Management.....	23-1
25.0	Hot-Mix Asphalt Pavement.....	25-1
26.0	Excavation and Embankment .....	26-1
31-3223.12	Soil Improvement by Compaction Grouting .....	31322312-1
47.0	Construction Survey and Monumentation .....	47-1

**Supplemental Information**

Measurement and Payment .....	Pages 1 thru 53
-------------------------------	-----------------



CITY AND COUNTY OF DENVER  
ENGINEERING DIVISION

# Wastewater Capital Projects Management Standard Construction Specification

---

## **01-00 Scope**

These Standard Construction Specifications set forth the provisions applicable to storm, sanitary and other related construction on Wastewater Capital projects, as specified. The general contractor is responsible for all materials and equipment necessary to perform all operations in connection with the construction of the facilities as described in approved plans, the most recent edition of these Standard Construction Specifications and the Wastewater Management Division Standard Details.

**END OF SPECIFICATION**



CITY AND COUNTY OF DENVER  
ENGINEERING DIVISION

# Wastewater Capital Projects Management Standard Construction Specification

---

## 01-1416 PUBLIC INFORMATION SERVICES

### PART 1- General

#### **1.01 Description**

The Work consists of providing various public involvement activities for the Project. Additional requirements may be included elsewhere within the Contract Documents.

Public information services shall include, at minimum, the following:

- a) Responding to questions concerning Project activities and schedules
- b) Participating in, and documenting meetings held with affected individuals, residents and/or business
- c) Maintaining ongoing communication with residents and businesses directly impacted by construction activities and traffic control plans for the project
- d) Maintaining a written log which documents calls and concerns. The log shall include: the nature of the concern, response(s) provided, date of completion for any required remedial action and any necessary future follow up with a frequency.

#### **1.02 Submittals**

The following shall be submitted to the Construction Project Manager:

- a) All construction notification letters intended for use on the project, shall be submitted for approval by the Construction Project Manager prior to issuance of a notice to proceed. Updated notification letters intended for distribution to the public will require re-review and approval prior to issuance and may require additional time for coordination through the district City Council office.
- b) The qualifications of the Contractor's assigned Public Information Manager shall be submitted to the Construction Project Manager prior to the preconstruction meeting for review
- c) An updated written log for calls and concerns received will be submitted on a weekly basis, unless directed otherwise

### **Part 2 – Product**

### **Part 3 – Execution**

### **3.01 Public Information Manager**

A Public Information Manager (PIM) for the Project shall be designated by the Contractor at the preconstruction meeting. The PIM shall be primarily responsible for maintaining communications and providing information on a regular basis to businesses and property owners affected by and adjacent to the work. The PIM shall be available on every calendar day and at all times during the course of the project from Contract Award through issuance of Final Acceptance. Interpretation services may be necessary and must be made available to ensure appropriate assistance is provided.

The PIM shall have a minimum of two Projects of previous experience in work with communications on similar Projects.

If directed by the Construction Project Manager, the PIM shall:

- a) attend regularly scheduled meetings of local neighborhood and business associations to discuss the project and schedule
- b) provide interpretation services
- c) distribute additional notifications to the public which provide project related information, service interruptions, or general construction progress updates
- d) provide timely input and review public information intended for use in neighborhood newsletters or publications, City Council updates, and local news media interviews or articles
- e) provide information, documents, photographs, input and review for information posted on City sponsored websites
- f) coordinate and communicate with adjacent projects/work, as well as utility companies working within the project limits to ensure proper notification of effected residents and business owners occurs and does not negatively impact the project

### **3.02 Public Information Phone Line**

The Contractor shall provide a public information, local call line for the Project which is accessible 24 hours a day, 7 days a week. The public information line shall be answered by a person with direct knowledge of the Project or by an answering machine with current Project information that is updated on a weekly basis and allows the recording of a message from the caller. Cellular phones are acceptable. All calls shall be returned by the PIM or their designee within 24 hours. This phone number shall also appear on the project signs and on all information distributed for the Project.

### **3.03 Construction Notification Letter**

The Contractor shall be required to prepare, submit for review and distribute construction notifications a minimum of 7 calendar days prior to starting work on each block. Notification and coordination shall occur with: property owners, tenants and/or businesses directly adjacent to or affected by the work, as well as those on side streets near the work site. It is the Contractor's responsibility to maintain ongoing communication with the affected property owners, tenants and/or businesses.

The notification shall provide a brief summary of the Project scope, work activities associated with the type of construction, general safety guidelines for the public and an anticipated completion date for the Project. In addition, the notification shall provide the name of the PIM and their telephone number. Notifications shall be updated and redistributed every two to

three weeks until construction is completed. The Contractor shall allow time for the Construction Project Manager to review and approve all updated notification letters prior to distribution.

**End of Specification**





CITY AND COUNTY OF DENVER  
ENGINEERING DIVISION

# Wastewater Capital Projects Management Standard Construction Specification

---

## 01-5213 TEMPORARY OFFICE FACILITIES

### **PART 1- General**

#### **1.01 Description**

This specification covers temporary office facilities during construction activities above that normally provided by the Contractor for use by the City and their designated personnel. This specification only applies when the corresponding bid item for temporary office facilities is included and is specifically stipulated in the contract documents.

The purpose of the temporary office facilities is to provide the necessary working area and resources for project team member meetings, City Construction Project Managers, City Construction Project Inspectors, Project Resident Engineers, or their designees.

The City and County of Denver is not responsible for the safety of the temporary office facilities and compliance with this specification does not relieve the Contractor of full responsibility for damage caused by the Contractor's operations.

#### **1.02 Submittals**

All submittals for this item shall be provided to the City Construction Project Manager for record keeping purposes and verification of conformance with the contract documents. These submittals or approval of the submittals does not shift liability or relieve the Contractor from full responsibility for adherence to specification.

Provide a detailed submittal for review and acceptance by the City Construction Project Manager detailing the product requirements described in Part 2 of this specification. Detail the location and layout of the temporary office facilities in the submittal(s).

### **PART 2- Product**

#### **2.01 Temporary Office Space**

The Contractor shall furnish and maintain a temporary office facility at or adjacent to the work site for use by City Construction Project Managers, City Construction Project

Inspectors, Project Resident Engineers, and/or their designees. An individual desk space is required for City Construction Project Inspectors, the City Construction Project Manager, and/or Project Resident Engineer; and additional space may be needed for specialty inspectors (geotechnical, structural, etc.)

Each individual desk space shall include one standard size desk with drawers, one desk chair and one side chair, a book case, a plan rack, a waste basket, lighting (50 foot candles at desk top), a duplex electrical outlet (110-volt), access to high speed internet (minimum 20Mbps), and a printer (capable of printing and scanning standard, legal, and 11-inch by 17-inch color prints).

The temporary office shall be structurally sound, secure, vandal resistant, weather tight, with floors raised above ground and have interior and exterior lighting. The temporary office shall be provided with automatic heating and mechanical cooling equipment to maintain comfort conditions of 70 degrees Fahrenheit year round and provide convenient access to potable drinking water and toilet facilities cleaned at least twice per month.

## **2.02 Temporary Meeting Space**

The Contractor shall furnish and maintain a temporary meeting space at the work site within the temporary office facility for use by project team members during meetings. The temporary meeting space shall be large enough to accommodate at least 8-persons, including a table and chairs. The meeting space shall have multiple wall mounted cork boards and white boards and a large wall mounted display clock for help in facilitating meetings.

## **PART 3- Execution**

Provide the City with and maintain full access to the temporary office facilities at least two weeks prior to starting ground disturbance at the project site. Allow the City and/or their designees' full access to the temporary office facilities during the duration of the project; including weekends, nights, and holidays if warranted by the project. Provide temporary access roads and maintenance if required to maintain access to the temporary office facilities. Provide snow removal as required.

The temporary office facilities shall be removed within 30 days after they are no longer needed or as directed by the City Construction Project Manager.

**END OF SPECIFICATION**



CITY AND COUNTY OF DENVER  
ENGINEERING DIVISION

## **Wastewater Capital Projects Management Standard Construction Specification**

---

### **2.0 Site Preparation**

#### **2.0.1 General**

The site of all trenches shall be cleared of all vegetation, stumps, roots, sod, and debris prior to excavating. Fences, walls, curbs, sidewalks, gutters, crosspans, poles, or any other structures stipulated on the drawings to be removed, or otherwise authorized by the Construction Project Manager to be removed, shall be removed and later replaced in a manner acceptable to the City and equivalent to its original undisturbed condition. Except as otherwise shown on the Drawings or otherwise specified herein all unsalvageable materials shall be removed or hauled from the site and disposed of by the Contractor at his expense. Unless otherwise specified in the Contract Documents or elsewhere in these Standard Construction Specifications, all salvageable materials and items shall become the property of the City. If, in the event it is specified that certain salvageable materials are to become property of the Contractor, no payment will be made for the removal of those items or materials.

#### **2.0.2 Stockpiling of Excavated Materials, Pipe, Etc.**

In accordance with and in addition to the requirements set forth in GC's 801-807 of the General Contract Conditions, no excavated materials, pipe, equipment, or any other items shall be stockpiled or stored on private property without the express written approval of the property owner of record. Duplicate copies of any written approval or authorization given to the Contractor shall be submitted to the Construction Project Manager and shall be so worded as to hold harmless the City of any responsibility whatsoever related to the stockpiling and storage of material and equipment. All costs incurred shall be borne by the Contractor.

#### **2.0.3 Construction Easements**

All additional temporary construction easements that the Contractor feels are necessary to perform the required work shall be coordinated, obtained and paid for by the Contractor. If these easements are granted to the Contractor, they shall be so worded as to hold harmless the City of any responsibility whatsoever related to any temporary construction easement obtained by the Contractor. Duplicate copies of the written authorization shall be submitted to the Construction Project Manager. All costs incurred under this item shall be borne solely by the Contractor.

**End of Specification**



CITY AND COUNTY OF DENVER  
ENGINEERING DIVISION

# Wastewater Capital Projects Management Standard Construction Specification

---

## **02-2213 Vibration Assessment**

### **Part 1 - General**

#### **1.01 Description**

This specification covers vibration monitoring during construction activities to include an existing condition survey, baseline equipment monitoring and the establishment of a vibration monitoring program for use during construction operations. . This specification only applies when the corresponding bid item for vibration assessment is included and is specifically stipulated in the contract documents.

The purpose of the vibration monitoring program is to assess possible impacts that construction activities might have to adjacent facilities during all phases of the work. These facilities include, but are not limited to buildings, bridges, underground utilities, surface facilities, structure foundations, and all other facilities within the proximity of the work.

The City and County of Denver is not responsible for the safety of the Work and compliance with this specification does not relieve the Contractor of full responsibility for damage caused by the Contractor's operations.

#### **1.02 Submittals**

All submittals are submitted to the Construction Project Manager for record keeping purposes and verification of conformance with the contract documents. These submittals do not shift liability or relieve the Contractor from full responsibility for damage that is deemed to be caused by the Contractor's operations.

- A. An independent vibration monitoring consultant will be used to fulfill the requirements of this section. The Contractor shall submit references for the consultant detailing at least

---

PWWCPM\_SCS  
SCS 022213-1

Revised: March 15, 2016

- two projects completed in the past five years where the vibration monitoring consultant has satisfactorily monitored construction operations by recording maximum peak particle velocities (PPVs). Include contact information for each reference. This information shall be submitted to the Construction Project Manager for acceptance prior to beginning use of the Consultant's services.
- B. The Contractor shall submit any facility condition survey that is done to the Construction Project Manager within 2 weeks of completion of the survey.
  - C. At a minimum, the Contractor shall submit any data and documentation derived from vibration monitoring along with interpretations of the results from the vibration monitoring consultant to the Construction Project Manager on a monthly basis.
  - D. The contractor shall offer formal training on how to access any web base data access site. A technical manual detailing all procedures for accessing the site shall be offered at the training session and submitted to the Construction Project Manager.

## **Part 2 – Product**

## **Part 3 – Execution**

### **3.01 Facility Condition Survey**

This work shall consist of performing a facility condition survey(s) and preparing permanent records as indicated in this specification prior to the commencement of work, after completion of work, and at locations and times during construction as needed to verify that adjacent facilities have not been damaged by any element of the work.

### **3.02 Vibration Monitoring Consultant**

- A. The Contractor shall, as specifically indicated in this specification, provide vibration monitoring to verify that construction activities will not or have not damaged adjacent facilities.
- B. The Contractor will obtain the services of an independent vibration monitoring consultant to assist in developing an existing condition survey, establish a vibration monitoring plan to include baseline and continuous monitoring, and interpret the results of the vibration monitoring as it relates to adjacent facilities.
- C. Vibration monitoring will be done near elements of the construction work which are likely to have the largest potential to damage adjacent facilities during the course of construction operations. This monitoring will be used to establish a baseline reading of these activities and will be done at a location of the work which is least likely to damage adjacent property. The vibration monitoring consultant will review the results of the

- baseline monitoring program and submit the results and their interpretation of the findings to the Construction Engineer in a report submitted on a monthly basis.
- D. Vibration monitoring will take place on a continuous basis during all construction activities. Continuous vibration monitoring will be done throughout the project at locations that are nearest the construction activities and which have the potential to damage nearby facilities. The location and number of vibration monitoring instruments will be as directed by the vibration monitoring consultant based on the results of the baseline monitoring, their interpretation of these results, and their experience based on the type of activity and proximity to nearby facilities.
  - E. The Consultant/Contractor shall provide protection for all instrumentation from vandalism or theft. Any costs associated with vandalism or theft shall be born by the general contractor. The City and County of Denver shall at no time entertain any claim for loss associated with vandalism or theft of instrumentation.
  - F. The vibration monitoring consultant will be a PE licensed in the state of Colorado, and will have performed vibration monitoring services in Colorado to include monitoring construction operations to record maximum peak particle velocities.
  - G. The Consultant/Contractor will submit monthly reports to the Construction Project Manager which detail the baseline monitoring results, a summary of the continuous vibration monitoring results at locations nearest the construction activities and include a summary interpretation of all the results collected over the past month.

**END OF SPECIFICATION**



CITY AND COUNTY OF DENVER  
ENGINEERING DIVISION

## Wastewater Capital Projects Management Standard Construction Specification

---

### **3.0 Existing Facilities**

#### **3.0.1 General**

The Contractor shall at all times take extreme and proper precautions for the protection of utilities, the presence of which are known or can be determined by the examination of appropriate utility maps, use of electronic locating, exploratory excavations, etc. The Contractor shall be responsible for all costs associated with the repair of any service and/or utility damaged by construction.

The Contractor shall notify Denver Water, Xcel Energy, telephone, cable and fiber optic companies, as well as property owners and all other interested parties, prior to commencement of work in order to ensure that there will not be service interruptions during construction. Existing utility lines and utility poles, trees, shrubbery, fences, water mains, gas mains, sewers, cables, conduits, curb, gutter, walks, and other structures in the vicinity of the work not authorized to be removed, shall be supported and protected from damage by the Contractor until all construction and related work is complete. The Contractor shall be liable for all damages to existing facilities, structures, and property.

#### **3.0.2 Utilities**

Utilities, underground and above-ground, shall include but not be limited to: fiber optics (including empty ducts), gas, telephone, electric, steam, water, sanitary and storm sewers, telegraph lines, conduits, all abandoned utilities, etc., and their accessories, appurtenances and service connections. The type, size, location, and number of all known above-ground and underground utilities have been shown on the drawings, however, no guarantee is made as to the true size, location or number of such utilities. It shall be the responsibility of the Contractor to verify the existence and location (vertically and horizontally) of all underground utilities along the route of the work, to ensure construction as shown in the Contract Documents. The omission from or the inclusion of existing or abandoned utility locations on the drawings is not to be considered as the nonexistence of, or a definite location of, said utilities.

#### **3.0.3 Exploratory Excavations**

Exploratory excavations shall only be paid at locations designated in the Contract Documents or as specifically approved by the Construction Project Manager, in writing. Otherwise, all costs incurred by the Contractor in making exploratory excavations shall be considered to be

included in the unit price bid for constructing each section of sewer line, structures, laterals and/or appurtenances.

In addition to those areas as may be designated in the Contract Documents, it shall be the Contractor's responsibility to excavate and locate all utilities and appurtenances which may affect construction or require protection during construction of the project scope. All exploratory excavations shall occur far enough in advance of the sewer facility construction to permit any necessary relocation or adjustment of the sewer facility without delaying the project.

### **3.0.4 Relocation and Adjustment**

If it is determined prior to, or during construction that any underground or aboveground utilities (as defined within this specification) are required to be relocated or adjusted, the Contractor shall notify the utility owner well in advance of the Contractor's approach of such utility so that arrangements with the owner or owners of the affected utility can be completed without delaying construction. It is the Contractor's responsibility to coordinate all utility relocations and adjustments required to complete the scope of work designated within the construction plans and documents. All utilities requiring relocation and/or adjustment shall be constructed in accordance with each specific owner's requirements, standard specifications, and applicable agreements. The costs associated with utility coordination, relocations, adjustments; and/or construction delays due to improper planning, scheduling or advance notification of utility owners by the Contractor, shall be included within the related pipe segments, structures and appurtenances. Unless otherwise provided for in the Contract Documents or specified elsewhere, the responsibility of relocating both underground and aboveground utilities within the project limits shall be borne by the Contractor. If operations by the Contractor cause damage to any utilities lying outside of the prescribed maximum trench width the utility shall be repaired at the sole expense of the Contractor. The Construction Project Manager may order such utilities to be protected or relocated at the sole expense of the Contractor.

#### **3.0.4.1 Water Services**

The type, size and location of water services are not shown on the construction plans and it shall be the Contractor's responsibility to identify and locate the services affected during construction. The Contractor is required to coordinate all water service relocations with Denver Water, well in advance of approach

The Contractor is required to maintain service and adjust all water service taps and/or connections encountered during construction. Service adjustments and reconnections for homeowners, businesses, and facilities with special circumstances will be completed during a timeframe which accommodates their needs. All work will be performed by a licensed plumber or journeyman drainlayer and shall be in accordance with Denver Water Standard Construction Specifications. No separate payment will be made for any of the work involved for this item and all costs incurred will be considered to be included in the applicable unit price bid for the associated pipe segments, structures and appurtenances.



### **3.0.4.2 Gas Services**

The type, size and location of gas services are not shown on the construction plans, and it shall be the Contractor's responsibility to identify and locate the services affected during construction. The Contractor is required to coordinate all gas service relocations with the utility owner, well in advance of approach. All work involved and costs incurred for this item will be included within the applicable unit price bid for the associated pipe segments, structures and appurtenances.

### **3.0.4.3 Sewer Services**

#### **1. Adjusting**

All storm and sanitary sewer services and/or connections crossed during construction shall be adjusted by the Contractor as required to maintain service. A licensed plumber or a licensed drainlayer shall perform all such work. Unless otherwise provided for in the Contract Documents, no separate payment will be made for any of the work involved for this item and all costs incurred will be considered to be included in the applicable unit price bid for the associated pipe segments, structures and appurtenances.

#### **2. Reconnection**

Where existing sanitary and/or storm sewer lines with service and/or lateral connections are being replaced, reconnection will be required at the locations shown in the contract documents, in addition to those located in the field by the Contractor and identified by the Construction Project Manager as active connections. Reconnection will also be required where a service or lateral connection was damaged as a result of work associated with this project. The contractor is also required to immediately and fully mitigate all damage to public or private property associated with the damaged service and/or lateral connection. This full and immediate mitigation shall be conducted regardless of apparent "fault" of the damage. The connections shall be reconnected by the Contractor utilizing standard tee or wye fittings, factory manufactured saddle taps, applicable pipe and reinforced concrete collars, adjustable repair couplings, etc. as specifically approved for construction by the Construction Project Manager. All service connections on PVC lines shall be constructed in accordance within these Standard Construction Specifications. Connections to sewer lines and structures shall be made using coring machines, keyhole saws, or other methods approved by the Construction Project Manager; jack-hammering or break in connections are not permitted. The Contractor will perform this work utilizing a licensed plumber or journeyman drainlayer. All connections must be reconnected to the new sewer line within twelve hours of discontinuance of service.

#### **3. Location and Verification**

All sewer services and/or lateral connections shall be located and verified by the Contractor prior to construction (both vertically and horizontally). The Contractor shall notify the owner well in advance of access to mainline sewers to allow coordination and planning with the pertinent maintenance groups. All costs associated with delays and maintenance of mainline facilities will be incurred by the Contractor. The Construction

Project Manager shall be notified immediately of any information acquired from locates and verifications which may affect the design or original scope of work.

Unless provided for elsewhere in the Contract Documents or specified elsewhere, no separate payment will be made for any of the work involved for these items and all costs incurred will be included in the applicable unit price bid for the associated pipe segments, structures and appurtenances.

### **3.0.5 Abandonment**

All existing sewer facilities to be plugged and abandoned in place are specifically shown on the Construction Drawings. Unless otherwise specified in the Contract Documents or elsewhere in the Special Conditions, the procedures and methods for the abandonment of said facilities shall conform to the following.

#### **3.0.5.1 Manholes/Inlets/Structures**

Manholes, inlets or miscellaneous structures to be abandoned in place shall have all pipes entering or exiting the structure plugged with lean concrete. Manhole tops or cone sections shall be removed to the first full barrel diameter section, and/or to a point not less than 24-inches below final grade. The structure shall then be backfilled and compacted in accordance with Backfill Method B as specified within these Standard Construction Specifications. Backfill material may be either: select backfill, clean suitable excavated material, or controlled low strength material approved by the Construction Project Manager. Surface restoration for the surrounding area shall be done in accordance within these Standard Construction Specifications.

Manhole rings, covers, inlet grates, frames, precast flat tops, cone sections, or other salvageable items shall be salvaged, stored and delivered to such location as prescribed by the Construction Project Manager.

The payment for abandoning manholes, inlets, and/or miscellaneous structures as described above; along with the materials, equipment and labor necessary to complete all surface restoration associated with these items shall be included within the appropriate bid item (regardless of the size or depth of item abandoned). Refer to applicable Measurement and Payment description for specific item inclusions.

#### **3.0.5.2 Sewer Lines**

Sewer lines to be abandoned in place shall be plugged with lean concrete and standard manufactured plugs or caps at both upstream and downstream ends of the abandoned section. If the manholes, inlets, etc. are also abandoned in place, or if the structure is to be removed completely, all sewer lines shall be plugged upstream and downstream of the removed structure following removal.

Sewer lines with an internal diameter of 24-inches or larger shall be filled with sand, pumped grout mixtures, or flowable fill, prior to final plugging. Unless otherwise noted in the Contract Documents, sewer lines with an internal diameter of 21-inches and smaller shall be plugged at entrance and exit ends with approved grout mixtures or concrete.

Unless provided for elsewhere in the Contract Documents or specified elsewhere, no separate payment will be made for any of the work involved for these items and all costs

incurred will be included in the applicable unit price bid for the associated pipe segments, structures and appurtenances.

### **3.0.6 Crossing of Existing Utilities**

See Wastewater Management Division Standard Detail S-350, for requirements and general notes.

**End of Specification**



CITY AND COUNTY OF DENVER  
ENGINEERING DIVISION

## Wastewater Capital Projects Management Standard Construction Specification

---

### 4.0 Utility Trenching and Excavation

#### 4.0.1 General

All excavations, trenching, shoring and stockpiling of excavated materials shall be in strict compliance with the applicable Occupational Safety and Health Act (OSHA) rules and regulations.

Except where shown otherwise on the Drawings, and except when the Construction Project Manager provides written permission to do otherwise, all trench excavation shall be made by open cut to the depth required to construct the pipe line as shown on the Drawings and specified herein. Permission for tunnel work may be granted by the construction project manager for crossing under sidewalks, driveways, or existing utility lines. No separate payment will be made for any of the work involved for these items and all costs incurred will be included in the applicable unit price bid for the associated pipe segments, structures and appurtenances.

The length of trench permitted to be open at any one time may be limited when, in the opinion of the Construction Project Manager, such limitation is necessary for the safety and convenience of the public; however, in no case shall the length of open trench exceed 400 feet, except when the Construction Project Manager provides written permission to do otherwise. All trenches and excavations left overnight shall be protected as specified by the Construction Project Manager. This may include, but is not limited to: fencing, concrete, barriers, additional signage or any other measures required to provide public safety.

#### 4.0.2 Subsurface Information

Whenever subsurface exploration, consisting of test holes and borings, has been made along the route of the work, the information obtained from these test holes will be included in both the Bid Submittal Package and the Contract Documents.

Subsurface information is provided for general information, and conditions may vary due to the location on jobsite and time of year. The City does not accept any responsibility for assumptions or generalizations made by the Contractor. Each bidder and Contractor must form their own opinion of the character of the work and of the materials to be excavated, and must make their own interpretations and investigations regarding all conditions affecting the work to be done.

### **4.0.3 Trench Width**

Except as may be otherwise specified on the Drawings, the maximum clear trench width measured at a point one (1) foot above the top of the pipe barrel shall not be greater than that set forth in the most recent edition of the Wastewater Management Division Standard Detail Drawings.

The trench width shall be sufficient to permit the pipe to be placed and jointed properly and to allow for the construction of appropriate structures and appurtenances. Adequate width shall be provided to allow backfill to be placed and compacted as specified. Pipe shall not be installed in a bedding trench having a width (as measured one (1) foot above the top of the pipe) greater than the outside diameter of the pipe plus sixteen (16) inches for pipe having internal diameters of thirty-three (33) inches or less. Bedding trench shall not be greater than the outside diameter of the pipe plus twenty-four (24) inches for all pipes with internal diameters of thirty-six (36) inches or more.

If the stated maximum trench widths are exceeded either through accident or otherwise and if the Construction Project Manager determines that the design loading of the pipe will be exceeded, the Contractor will be required to either support the pipe with an improved trench bottom or to use a stronger class of pipe. The cost of such remedial measures shall be entirely at the Contractor's own expense. If deemed necessary, the Contractor shall brace or shore this portion of the trench excavation to maintain the required trench width at the top of the pipe.

### **4.0.4 Trench Walls**

All trench sidewalls shall be properly sloped, benched, braced, shored or sheeted to assure safe working conditions and to prevent cave-ins. All trench operations including sloping or benching of the trench sidewalls and stockpiling of excavated materials shall be confined to the width of the permanent rights-of-way plus any temporary construction easements.

#### **4.0.4.1 Sloping or Benching**

Sloping or benching of the trench walls will normally be allowed, provided that such sloping or benching complies with all applicable State and Federal requirements as defined within these Standard Construction Specifications; and provided further, that such sloping or benching does not endanger adjacent utilities or structures or the public. In the event the Contractor elects to slope or bench the trench sidewalls, the sloping or benching shall terminate at a depth not less than one (1) foot above the top of the pipe barrel and, from that point to the bottom of the excavation, the trench wall shall be vertical (with adequate shoring as necessary). All additional costs for backfilling and surface restoration, for trenches which exceed the maximum width defined within the Standard Constructions shall be borne by the Contractor.

#### **4.0.4.2 Bracing Shoring, Sheeting**

The sides of the excavation shall be securely held in place with suitable bracing and shoring wherever necessary to prevent caving. In addition, bracing, shoring, sheeting, etc. shall be in accordance with all applicable State and Federal. Shoring shall be removed as the work

and backfilling operations progress, unless ordered by the Construction Project Manager to be left in place. The Contractor will be responsible for minimizing the disturbance of compacted bedding during advancement and removal of shoring within the bedding trench zone. All voids and separations shall be backfilled and recompacted with the appropriate bedding materials and in conformance with these Standard Construction Specifications. The Contractor will be paid for shoring so ordered left in place on the basis of invoiced material only. All other shoring shall be considered as incidental to construction and all costs incurred, except for materials ordered to be left in place, will be considered to be included in the unit price bid for the construction of each section of sewer, associated structures, laterals and appurtenances.

The decision to brace, shore or sheet the excavation shall be entirely the Contractor's responsibility. However, if the Construction Project Manager is of the opinion that any part of the excavation is not properly supported, the placement of additional supports or implementation of other methods by and at the expense of the Contractor may be required. Compliance with such order shall not relieve or release the Contractor from his/her responsibilities to provide a safe work zone.

#### **4.0.5 Preparation of Foundation for Pipe Laying**

When the excavation is in firm soil, care shall be taken to avoid excavation below the established grade (i.e. the specified overdepth to accommodate the particular class of bedding). The different methods and classes of bedding are described within these Standard Construction Specifications.

##### **4.0.5.1 Dewatering**

During construction, the Contractor shall provide and maintain adequate equipment to properly remove and dispose of all water entering the trench or other part of the work. In water bearing strata, well points, sub drains or any other method approved by the Construction Project Manager that may be required to provide a dry trench.

Pipe trenches shall be kept free from water during excavation, fine grading, pipe laying and jointing. Dewatering, sufficient to provide a completely dry trench, shall be maintained during all pipe laying and jointing operations. The Contractor shall be responsible for damage resulting from the dewatering operations.

The discharge from any trench dewatering operations shall be conducted to natural drainage channels or other structures as approved by the Construction Project Manager and in accordance with applicable permits. Ground water shall not be discharged into sanitary sewers.

Unless provided for in the Contract Documents, dewatering shall be considered as incidental to construction and all costs incurred will be considered to be included in the unit price bid for the construction of each section of sewer line, associated structures, laterals and appurtenances.

##### **4.0.5.2 Overexcavation and Replacement with Select Backfill Material**

If soft or otherwise unsuitable foundation material is encountered during the course of completing the work, it shall be removed and replaced with select backfill material and/or

angular rock bedding material so as to provide a suitable foundation for the pipe, structure and/or appurtenance or roadway, as determined by the Construction Project Manager.

In the event that overexcavation and replacement with select backfill material is below the water table, the sub-bedding material shall consist of 3/4 to 1-1/2-inch rock (or larger if approved). All work shall conform to the most recent edition of the Wastewater Management Division Standard Details.

If provided for in the Contract Documents, the cost of overexcavation and replacement with select backfill material will be paid for per the associated measurement and payment description. If no pay item for such work is included in the Contract Documents, the Contractor shall consider all costs incurred to be included in the unit prices bid for the construction of each section of sewer, associated structures, laterals and appurtenances.

At the option of the Construction Project Manager, select backfill material meeting the requirements of these Standard Construction Specifications may be delivered to the job site for the Contractor's use. The Contractor will be paid for placement of this material and the removal and disposal of the overexcavated material per the associated measurement and payment description.

#### **4.0.6 Unsuitable Materials Excavation**

Unsuitable material encountered within an excavated area during construction shall be excavated and disposed of by the Contractor as directed by the Construction Project Manager. Payment for excavation, disposal and replacement of unsuitable materials will not be paid for unless specifically authorized in writing by the Construction Project Manager. It may be necessary for the Contractor to rework, solely at the Contractor's own expense; dry, wet or otherwise satisfactory excavated material as necessary to obtain conformance with backfill requirements. Unsuitable materials are defined as:

1. Rock Excavation: Rock shall be defined as material consisting of igneous, metamorphic and sedimentary materials which cannot be excavated without blasting or the use of rippers, or boulders or other detached stones having a volume of ½ cubic yard or more, or having a specific gravity of at least 2.24 and weight not less than 140.4 pounds per cubic foot. The unit price bid for rock excavation will include granular bedding, select material, or any other material specifically approved in writing by the Construction Project Manager required to fill the excavated area.
2. Soil and excavated material containing rubbish, organics, frozen material, broken pavement, debris, stones larger than three (3) inches in diameter.
3. Muck, defined as an organic soil consisting of highly decomposed materials with more than 30% organic material and are generally referred to as peat or muck. These soils have bulk densities as low as 25 to 37 lb/ft<sup>3</sup>.
4. Material determined to be of such an unstable nature as to be incapable of being compacted to the specified density using ordinary methods, at optimum moisture content.
5. Material which is too wet to be properly compacted and circumstances prevent suitable in-place drying prior to incorporation into the work.

6. For backfill to be used within a street, roadway or any other area where the degree of compaction is critical, material having a plasticity index greater than twenty (20) shall be considered unsuitable.
7. Material otherwise unsuitable for the planned use per the Contract Documents.

#### **4.0.7 Pavement and Sidewalk Cuts**

Where excavation is required under concrete or asphalt paved areas, including gutters and walks, the surfacing material shall be cut or rotomilled in such a manner as to produce a smooth, structurally sound, straight cut edge and confine the excavation to a minimum practical width. All pavement removals shall be neatly cut, rectangular or trapezoidal in shape, and edges shall be parallel, perpendicular or skewed up to 45°. The pavement or concrete shall be cut or removed at least one (1) foot beyond the top width of the trench on each side. All broken pavement, asphalt, concrete or other debris resulting from this initial work shall be immediately removed from the job site or stockpiled in an approved manner so that it is kept separated from the remaining trench excavation. This debris will not be allowed to be mixed in the trench backfill material.

#### **4.0.8 Cut-off Walls**

Cut-off walls are only required as noted in the contract documents and as specifically requested by the Construction Project Manager to prevent migration of water through the pipe bedding zone. The Construction Project Manager may specify alternate locations from those shown in the plans. Concrete cut-offs are the preferred installation method. Refer to Wastewater Management Division Standard Detail S-301.1 figure 2 for typical locations and additional information.

**End of Specification**





CITY AND COUNTY OF DENVER  
ENGINEERING DIVISION

## Wastewater Capital Projects Management Standard Construction Specification

---

### 5.0 Bedding and Backfilling

#### 5.0.1 General

This section outlines the guidelines and requirements for pipe bedding and backfilling operations required to complete construction per the Contract Documents.

#### 5.0.2 Pipe Bedding

Unless specified otherwise on the Drawings or elsewhere in the Contract Documents, or directed otherwise by the Construction Project Manager, the Contractor shall bed all conduit according to the Class B Bedding method using a crushed granular, mineral aggregate material as noted in these Standard Construction Specifications and install the required geotextile over the pipe and/or bedding. Substitutions of recycled materials or manufactured materials in place of mineral aggregate mixtures for pipe bedding will not be allowed. If, in the course of construction, it is determined that the pipe foundation is unsatisfactory or the prescribed maximum allowable trench width is exceeded, the Construction Project Manager may require that an alternate class of bedding be installed. The Contractor shall be required to place the improved bedding class or make other remedies, at his/her expense.

No separate payment will be made for placement of the required bedding material. All costs incurred will be considered to be included in the unit price bid for each section of sewer line, associated structures, laterals and appurtenances.

##### 5.0.2.1 Bedding Materials

###### 1. #67 Bedding

This bedding shall consist of a durable crushed granular material with a well graded mineral aggregate mixture, which will provide good stability. This bedding shall not contain recycled or manufactured materials. The size range of the aggregate shall be from 1/4-inch minimum to 3/4-inch maximum with a maximum amount of fines passing a No. 8 sieve not to exceed 5% by weight and shall conform to ASTM C-33 or ASTM D-448, gradation size #67. At least 50% of the material greater than the 3/8-inch sieve shall contain particles having 3 or more fractured faces.

CLASS 67 GRADATION	
Nominal Size	Percent Passing by Weight
$\frac{3}{4}$	90-100
$\frac{3}{8}$	20-55
No. 4	0-10
No. 8	0-5

## 2. Special Bedding Material

Special bedding material shall only be used where required within the Contract Documents and as specifically approved by the Construction Project Manager. This material is intended for use on rigid pipe of sixty (60) inches or greater in diameter and shall not be used with flexible conduits. Additionally, this bedding shall not contain recycled or manufactured materials. The following gradation requirements shall apply:

SPECIAL BEDDING MATERIAL	
Nominal Size	Percent Passing by Weight
$\frac{3}{8}$	100
No. 4	80-100
No. 16	35-65
No. 50	10-25
No. 100	5-10
No. 200	3-8

## 3. Alternate Classes of Bedding

Alternate classes of bedding may be required within the Contract Documents or requested within the project scope. All such bedding materials must be submitted and separately approved for use by the Construction Project Manager. Recycled or manufactured materials will not be considered and alternate bedding materials used on site which have not been approved shall be rejected and the removal and replacement of these materials will be at the Contractor's expense.

### 5.0.2.2 Bedding Requirements

On rigid pipe of fifteen (15) inches or less in diameter and on all pipe classified as flexible, the bedding shall be continued until the bedding is filled to one foot above the top of the pipe. On rigid pipes eighteen (18) inches or greater in diameter, the bedding can be terminated at a point equal to the spring line of the pipe.

Conduit Type	Bedding Requirements*	
	≤15" Diameter	≥18" Diameter
Reinforced Concrete Pipe (RCP, HERCP, etc.)	1' Above Top of Pipe	Spring Line of Pipe
Reinforced Polymer Mortar Pipe (RPMP)	1' Above Top of Pipe	
Ductile Iron Pipe (DIP)	1' Above Top of Pipe	
Corrugated Metal Pipe (CMP, CSP, ASP, etc.)	1' Above Top of Pipe	
Polyvinyl Chloride Pipe (PVC)	1' Above Top of Pipe	
High Density Polyethylene Pipe (HDPE)	1' Above Top of Pipe	
Reinforced Concrete Box Culvert (RCB or RCBC)	6" Below Outside of Box	
* Based on internal diameter or equivalent internal diameter of conduit		

### 5.0.2.3 Bedding Methods

#### 1. Class A Pipe Bedding

Class A Bedding shall be defined as that method of bedding by which additional supporting strength of the pipe is attained by supporting the lower part of the pipe with a concrete cradle or distributing trench loads on the upper portion of the pipe by means of a concrete arch.

In those instances where Class A Bedding is required, the Contractor shall construct either a concrete cradle or concrete arch as specifically noted in the Contract Documents or as directed by the Construction Project Manager. Class A Bedding shall be constructed of non-reinforced concrete with a minimum 28-day compressive strength ( $f'_c$ ) of no less than 2000 psi, unless otherwise noted. Additional requirements for either type of construction are specified below. Class A Bedding will normally not be allowed for flexible type installations such as corrugated steel pipe, plastic pipe, etc.

After concrete cradle or arch bedding has been constructed, no backfilling shall be completed above the pipe until the concrete has attained the required minimum compressive strength. Where sheeting is removed or left in place, all cavities remaining, adjoining and/or behind shall be firmly filled with a suitable backfill material.

**a. Concrete Cradle**

This method of Class A Bedding construction shall consist of bedding the lower part of the pipe in a poured-in-place concrete cradle. The minimum thickness of concrete under and around the conduit shall not be less than that specified on the most recent edition of the Wastewater Management Division Standard Detail Drawings.

The concrete shall extend upward around the pipe a minimum distance of  $\frac{1}{4}$  of the outside diameter (but not less than 4-inches), measured from the lowest portion of the pipe exterior. The width of the concrete cradle shall be at least equal to the outside diameter plus 8-inches. Blocking material required to support the pipe prior to placement of concrete shall have a minimum compressive strength of 2000 psi. The remaining excavation to a point two (2) feet above the top of pipe shall be backfilled and compacted in accordance with Backfill Method B as specified in Section 5.0 of the Standard Construction Specifications.

**b. Concrete Arch**

This method of Class A Bedding construction shall consist of bedding the upper part of the pipe in a poured-in-place concrete arch. The minimum thickness of concrete over and around the conduit shall not be less than that specified in the most recent edition of the Wastewater Management Division Standard Detail Drawings.

The concrete shall extend upward around the pipe a minimum distance of  $\frac{1}{2}$  the outside diameter plus 4-inches, measured from the spring line of the pipe. The width of the concrete arch shall be at least equal to the outside diameter plus 8-inches. Where a concrete arch is required, the lower portion of the pipe (from spring line down) shall be bedded with Class B bedding, in accordance with this section. The remaining excavation to a point two (2) feet above the top of pipe shall be backfilled and compacted in accordance with Backfill Method B as specified in Section 5.0 of these Standard Construction Specifications.

**2. Class B Pipe Bedding**

Class B Bedding shall be defined as that method of bedding in which the pipe is set on an approved granular material. The trench shall be excavated to a depth below the bottom of the pipe as specified in the Wastewater Management Division Standard Details. The overexcavation shall be backfilled and compacted with a clean granular material free from organic and/or unsuitable materials. The material shall be placed under the pipe and on either side of the pipe up to depths specified within these Standard Construction Specifications. The placing shall be done in a manner which will assure no separation or change in uniform gradation.

All bedding material shall be placed under the pipe haunches, then brought up in six inch (6") lifts (maximum) and compacted by hand operated mechanical vibrators equally and thoroughly along each side of the pipe in such a manner as to avoid displacement of, or damage to the pipe. All bedding material shall be compacted to a density of at least ninety percent (90%) as determined by the Modified Proctor Method, AASHTO designation T-180, before the next lift is placed. Refer to Wastewater Management Division Standard Detail S-301.2 for additional information.

In no case will jetting or flooding be allowed as means for consolidation or compaction of the bedding material. Cut-off walls will be required to be installed as described in these Standard Construction Specifications and as shown on the Wastewater Management Division Standard Details.

### **5.0.3 Backfill**

Excavated material will be considered suitable for backfill purposes, provided its use results in a well-compacted stable condition. All backfill material shall be free from rubbish, organics, frozen material, broken pavement, debris, stones larger than three (3) inches in diameter, or other unsuitable materials.

Material having a plasticity index greater than twenty (20) shall not be used for backfill within a street, roadway, or any other area where the degree of compaction is critical. It may be necessary for the Contractor, at his/her sole expense, to dry, wet, mix or otherwise rework satisfactory excavated material as necessary to obtain conformance with these Standard Construction Specifications.

The use of squeegee material or pea gravel will not be allowed as backfill material due to their free flowing nature if undermined. These materials may be used as pipe bedding if required by a specific utility owner, but they must be consolidated by vibration prior to backfilling operations.

When, in the opinion of the Construction Project Manager, the excavated material is unsuitable for use as backfill, or when there is a shortage of satisfactory backfill material within the project limits, the Contractor shall locate and furnish all necessary suitable backfill material and shall dispose of the unacceptable material. All excess backfill or unacceptable excavated material shall be disposed of off the rights-of-way and public property by the Contractor, unless directed otherwise by the Construction Project Manager. Backfilling shall be performed in strict conformance with these Standard Construction Specifications.

#### **5.0.3.1 Trench Backfill**

The entire area from pipe subgrade to the finished surface elevation shall make up the trench backfill zone. This zone consists of two (2) main sections described below: the Bedding Trench and the Backfill Above Bedding Trench. All areas outside of this zone will be considered Backfill Outside the Trench.

Unless otherwise set forth in the Contract Documents, the cost of the bedding and trench backfill requirements shall be included in the associated unit price bid for the respective sewer line, associated structures, laterals and appurtenances.

## **1. Bedding Trench**

The Bedding Trench is defined as starting at the subgrade of the specified overdepth required to accommodate the particular class of bedding below the bottom of the pipe and extends vertically to a point where the bedding is terminated (as defined under Bedding Requirements above).

The bedding trench shall be backfilled with an approved bedding material, in accordance with Class A or Class B Bedding methods immediately after the pipe is laid, except where the pipe must remain exposed for leakage tests (subject to the provisions of these Standard Construction Specifications).

## **2. Backfill Above Bedding Trench**

Backfill Above the Bedding Trench shall be considered as starting one foot above rigid pipe fifteen (15) inches in diameter or less and for all pipe classified as flexible; or at the spring-line for rigid pipe eighteen (18) inches and larger in diameter. All material below these areas shall be considered as bedding material. Refer to the Bedding Requirement table included within this section for further clarity based on pipe types.

## **3. Backfill Outside the Trench**

All backfilling required during construction which is outside of the Trench Backfill Zone, as defined above, will be considered Backfill Outside the Trench. These materials shall meet the requirements set forth in this specification.

Backfill for cast-in-place or precast structures and appurtenances, including but not limited to: manholes, transition structures, junction structures, vaults, inlets and concrete box culverts, shall start at the subgrade for the structure, or appurtenance. As a minimum requirement all structures, inlets, manholes and appurtenances will follow Method B backfill procedures as described in this specification. All remaining operations which fall under Backfill Outside the Trench will follow method A backfill procedures as a minimum, unless specified otherwise in the Contract Documents or directed by the Construction Project Manager.

### **5.0.3.2 Backfilling Methods**

After the specified pipe bedding has been placed, compacted and approved, and after the requirements for the bedding trench have been fulfilled and the Construction Project Manager has approved the commencement of backfilling operations, the balance of the trench shall be backfilled and compacted in accordance with one of the methods described below. The contractor shall not temporarily backfill trenches and return later to re-excavate and meet the backfill method requirements. The Contractor shall consider the minimum backfill and compaction requirements to be in conformance with Backfill Method A for pipeline trenches and Backfill Method B for pipe bedding, backfill under or around manholes, structures, inlets, utilities and appurtenances, unless specified otherwise in the Contract Documents.

The use of hand held tools or devices to meet compaction requirements shall be continued around and above the pipe section during the trench backfilling process until a minimum

vertical height above the pipe of two (2) feet is reached. Thereafter, the use of approved compaction equipment (vibratory, sheepsfoot, rubber-tire, etc.) may be utilized. Impact, free fall, stomping and jetting operations are not permitted unless specifically approved by the Construction Project Manager.

The Contractor shall exercise the utmost care during compaction by any of the methods described below, to assure that no damage will occur to the sewer, appurtenances or other existing utilities. Any damage resulting from compaction shall be repaired or replaced at the Contractors expense.

### **1. Backfill Method A**

The backfill shall be placed in horizontal layers of such depths as are specified below for the material being placed and the type of equipment being used. Granular soils shall be compacted by vibration; whereas cohesive soils shall be compacted by a kneading action.

Material for mechanically compacted backfill shall be placed in lifts, which, prior to compaction, shall not exceed the thickness specified below for the various type of equipment:

- a. Vibratory equipment, including vibratory plates, vibratory smooth-wheel rollers, and vibratory pneumatic-tired rollers - maximum lift thickness of two (2) feet;
- b. Rolling equipment, including sheepsfoot (both vibratory and non-vibratory), grid, smooth-wheel (non-vibratory), pneumatic-tired (non-vibratory), and segmented wheels-maximum lift thickness of one (1) foot;
- c. Hand-directed mechanical tampers - maximum lift thickness of six (6) inches.

Permission to use specific compaction equipment shall not be construed as guaranteeing or implying that the use of such equipment will not result in damage to adjacent ground, existing improvements, or improvements installed under the Contract Documents. The Contractor shall make his/her own determination in this regard.

It will be the Contractors responsibility to maintain a minimum of eighty-five (85%) density from the top of bedding to a distance of two (2) feet over the top of pipe. The density from two (2) feet over the top of pipe to the subgrade surface shall maintain a minimum of ninety percent (90%) density. Regardless of facility depth, the last foot of subgrade material shall be compacted to a minimum density of ninety percent (90%). All densities shall be determined by the Modified Proctor Method, AASHTO Designation T-180. Each lift of backfill material shall have the proper moisture content and consistency to permit compaction to the designated density. The compacted material may be tested at any time for adherence to these Standard Construction Specifications.

### **2. Backfill Method B**

This method of backfilling requires placement in six (6) inch lifts. Each lift will have the proper moisture content and consistency to permit compaction to the prescribed density. Each lift will be uniformly and completely compacted by either handheld pneumatic or mechanical tampers to a density of at least equal to ninety percent (90%) of the density

determined by the Modified Proctor Method, AASHTO designation T-180, before the next lift is placed.

### 3. Backfill Method C

Other methods of backfill placement and compaction to the prescribed density may be submitted to the Construction Project Manager by the Contractor. These methods will not be used without the prior written approval of the Construction Project Manager.

#### 5.0.3.3 Select Backfill Materials

Select materials shall only be used as backfill when specifically shown in the Contract Documents or as approved and authorized by the Construction Project Manager and will only be placed to the specified depths in those areas as shown on the Contract Documents or as ordered by the Construction Project Manager. The materials listed here are only intended for backfilling purposes and shall not be used for pipe bedding at any time. Prior to using select materials onsite, the Contractor shall submit product documentation for approval. All select material placed without approval from the Construction Project Manager will be rejected and the Contractor will incur all costs associated with removal and replacement of the material.

#### 1. Subgrade Material (Select Backfill)

Select subgrade material, which may also be specified as “select backfill material” in other locations within the Contract Documents, shall be defined as a well graded mixture of sound mineral aggregate particles containing sufficient, proper quality binding material to secure a firm, stable foundation when placed and compacted. When tested with laboratory sieves, the material shall meet the following gradation requirements:

Standard Sieve Size	% Passing (by Weight)
3 inch	100
No. 10	80 maximum
No. 200	0-15 maximum

All select subgrade material shall be of such quality that material passing a No. 40 sieve will have a liquid limit of not more than thirty five (35) and a plasticity index of not over six (6) when tested in conformity with AASHTO Designations T-89 and T-91 respectively. In addition, the City will take soil-bearing tests where necessary, to evaluate the quality of materials produced from pit sources. If the bearing value or stabilometer values of pit materials are considered to be adequate, minor deviations (less than five percent) from the liquid limit and plasticity index criteria specified shall not be considered to be a basis for rejection of the material. It shall be the responsibility of the Contractor to locate material meeting these Standard Construction Specifications and to secure approval of the Construction Project Manager before such material is delivered to the project. If at



any time during the construction, such tests reveal that the material being delivered is not of suitable quality for the purpose for which it is intended, the City reserves the right to direct the Contractor to change pit locations as necessary, at no cost to the City. If the Contractor so elects, he/she may, at his/her own expense, remove and dispose of the excavated material even if the Construction Project Manager considers it satisfactory for use as backfill, and replace it, at his/her own expense with select backfill material.

**2. Structural Fill**

Structural Fill shall be defined as a well graded mixture of sound mineral aggregate particles void of debris containing sufficient proper quality binding materials to secure a firm, stable foundation when placed and compacted. When tested with laboratory sieves, the material shall meet the following gradation requirements:

Standard Sieve Size	% Passing (by Weight)
2 inch	100
No. 4	30-100
No. 50	10-60
No. 200	5-20

Bearing value and or stabilometer tests by CBR or R value methods may be required to properly evaluate the quality of the material.

Colorado Department of Transportation approved class 4, 5, or 6 base course materials typically meet the above specifications. A report showing the gradation analysis and test results for the materials proposed for Structural Fill shall be required by the Construction Project Manager prior to placement and in accordance to AASHTO designations T-89 and T-91.

**3. Recycled and Processed Materials**

Recycled and processed materials shall include: recycled concrete, aggregates, asphalt, crushed gravel base course (road base), crusher fines or any other materials specified as such. The use of these materials within the construction site shall be limited to those areas designated within the Contract Documents or approved by the Construction Project Manager.

The following gradations are provided as a guideline for recycled and processed materials commonly used in construction and represent only a portion of those available for use. Approved submittals will be required prior to placement, to ensure that the material type and particle distribution are suitable for the intended application. All materials of this category placed without previous approval of the Construction Project Manager shall be rejected and all costs incurred for removal and replacement of these materials will be at the Contractor’s expense.

a. Crushed Recycled Concrete

Standard Sieve Size	% Passing (by Weight)
1½ inch	100
¾ inch	40-75
¼ inch	25-50
No. 40	5-20
No. 200	10 max

b. Crushed Recycled Asphalt Pavement

Standard Sieve Size	% Passing (by Weight)
1½ inch	100
¾ inch	40 minimum

c. Crushed Gravel Base Course (CDOT Class 6 Road Base)

Standard Sieve Size	% Passing (by Weight)
¾ inch	100
No. 4	30-65
No. 8	25-55
No. 200	3-12

d. Crusher Fines

Crusher fine material shall meet the gradation shown in the following table. The material shall consist of fine mineral fragments resulting from rock crushing operations.

Standard Sieve Size	% Passing (by Weight)
¾ inch	100
No. 4	90-100
No. 8	55-80
No. 16	40-70

Standard Sieve Size	% Passing (by Weight)
No. 30	25-50
No. 200	6-15

#### 4. Controlled Low Strength Material (CLSM)

Controlled Low Strength Materials (CLSMs) consist of a well-graded mixture of mineral aggregates, cementitious materials, water and admixtures. Other common names for CLSMs include: flowable fill, flowfill, non-shrink backfill, fly ash fill and controlled density fill.

The contractor will be required to submit a mix design and test data to the Construction Project Manager for approval, prior to excavating the area for which CLSMs are proposed for use. All materials of this category placed without previous approval, or which do not perform as specified, will be rejected by the Construction Project Manager and all costs incurred for removal and replacement of these materials will be at the Contractor's expense.

All CLSMs shall adhere and conform to the following, unless noted otherwise:

- a. The mix must be capable of freely flowing to fill all voids in trenches or other areas without compaction or other additional effort,
- b. The mix must be of uniform density and low permeability to prevent migration of adjacent fines into the set mix,
- c. Must be placed in a uniform manner that will prevent voids or segregation of the backfill and shifting of pipelines, structures and appurtenances. Foreign material that falls into the trench prior to, or during placement shall be immediately removed,
- d. The CLSM shall be produced using a central-mixed concrete plant or other approved method,
- e. Chemical admixtures containing chlorides shall not be used unless approved otherwise,
- f. CLSMs will be classified as either Standard Aggregate or Fine Aggregate CLSM according to the table below. Submitted CLSMs must follow the gradation guideline provided here, unless approved otherwise:

Standard Sieve Size	% Passing (by Weight)
1 inch (For Standard Aggregate CLSM)	100
$\frac{3}{8}$ inch (For Fine Aggregate CLSM)	100
No. 8	50 minimum

No. 200	0-30 maximum
---------	--------------

- g. The 28-day compressive strength must be between 50 and 150psi, unless otherwise directed by the Construction Project Manager. Test cylinders may be required to insure that the specified strength is obtained. The compressive strength shall be determined by ASTM D4832, "Preparation of Testing of Soil-Cement Slurry Test Cylinders",
- h. The mix shall have a slump between 7 and 10 inches as per AASHTO Designation T 119-82,
- i. When CLSMs are placed within the right-of-way, or they are to be covered by paving materials, the final set product must achieve a maximum indentation diameter of 3-inches prior to covering and opening the area to traffic. Penetration resistance shall be as measured by ASTM C6024, "Standard Test Method for Ball Drop on Controlled Low Strength Material to Determine Suitability for Load Application",
- j. Final set product shall excavate easily, minimizing the risk of damage to buried utilities during future work,
- k. Must be placed within 2 hours after mixing at the batch plant, unless otherwise approved or specified by the Construction Project Manager,
- l. Delivery tags shall be collected from the delivery driver and provided to the Project Inspector or Construction Project Manager. The delivery tag shall contain the supplier name, the mix identifying name and/or number as listed in the supplier's submitted mix design. The Project Inspector or Construction Project Manager may reject any mix that does not appear to meet the requirements of this specification (segregation, insufficient slump, open graded aggregates, etc.).

**5. Topsoil**

Topsoil shall be defined as soil that contains the sufficient organic materials necessary to support growth of grass, which is free of all types of debris, weeds, stones or other unsuitable materials. Topsoil will be required to be placed and compacted whenever excavation occurs through parks or other landscaped areas and the excavated material is deemed to be unsuitable for growth. Placement will be required from the existing subgrade to the depth specified in the Contract Documents or as otherwise directed by the Construction Project Manager. All topsoil used within the construction site shall conform to the Contract Documents and/or the specifications set forth by the owner of property affected during construction. Topsoil may also be specified as Class B Topsoil.

Class B topsoil shall be the original top layer of the soil profile formed under natural conditions, technically defined as the "A" horizon by the Soil Society of America. It shall have demonstrated by evidence of healthy vegetation growing or having grown on it,

prior to stripping, that it is well drained and does not contain substances toxic to plant life. It shall be the responsibility of the Contractor to locate material meeting these Standard Construction Specifications and to certify that the material is suitable for the intended purpose. The contractor must also secure approval of the Construction Project Manager before such material is delivered to the project.

Topsoil shall not be placed until the areas to be covered have been properly prepared and grading operations in the area have been completed. Topsoil does not require compaction but shall be keyed to the underlying material by the use of rollers or other equipment suitable for the purpose. Water shall be applied to the surface in a fine spray by nozzles or spray bars in such a manner that the operation does not wash or erode the topsoil areas.

#### **6. Other Classified Select Materials**

Alternate select materials, stabilization materials, and angular rock bedding materials shall be considered as other classified select materials.

Whenever the excavated material is deemed to be unsuitable for backfill and there is no requirement for the placement of any of the above specified select materials, other classified select materials shall be placed and compacted. It shall be the responsibility of the Contractor to locate such material and to secure written approval of the Construction Project Manager before such material is delivered to the project.

#### **5.0.3.4 Unsuitable Material**

Unsuitable material encountered within the project boundaries during construction shall be excavated and disposed of by the Contractor. Unsuitable material is defined as:

1. Soil and excavated material containing debris, weeds, asphalt, stones or concrete (larger than 3-inches in diameter), rubbish, and frost or other frozen particles,
2. Material determined to be of such an unstable nature as to be incapable of being compacted to the specified density using ordinary methods, at optimum moisture content,
3. Material which is too wet to be properly compacted and circumstances prevent suitable in-place drying prior to incorporation into the work,
4. Material otherwise unsuitable for the planned use per the Contract Documents.
5. Any fill material or soils not meeting regulatory and City standards for contamination

The presence of excessive moisture in a material is not, by itself, sufficient cause for determining that the material is unsuitable. Additionally, material which becomes unsuitable due to negligence or the means and methods utilized by the contractor will not be considered for payment. The costs incurred to remove and replace these materials shall be included in the associated unit price bid for the respective sewer line, associated structures, laterals and/or appurtenances.

The cost of removal of unsuitable backfill material and replacement with suitable material encountered while completing the project scope and which do not meet the above, will be paid for per the applicable bid items and in accordance with the associated measurement and payment description.

**End of Specification**



CITY AND COUNTY OF DENVER  
ENGINEERING DIVISION

## Wastewater Capital Projects Management Standard Construction Specification

---

### 6.0 Surface Restoration

#### 6.1 General

Where pavement, curb and gutter, sidewalks, drainage culverts, headwalls, or other structures or improved surfaces, landscaping, etc., have been removed during the course of the work, such items shall be restored to a condition at least equal to that prior to removal and to the same elevation and alignment. The subgrade for all restored surfaces shall be thoroughly compacted to the specified limits by mechanical or hand tampers.

#### 6.2 Asphalt Replacement

Except as modified herein, asphaltic concrete paving material to be replaced over trench excavations shall conform to the MGPEC asphalt paving requirements.

##### 6.2.1 Thickness

Unless otherwise stipulated in the **Proposal** or on the Plans, all asphalt pavement required to be removed for trench or structural excavation shall be replaced with a "full depth" asphaltic concrete paving section conforming to the depths specified on the Plans.

##### 6.2.2 Materials

The materials to be used for asphaltic concrete pavement shall conform to **Item 20** of the **Standard Construction Specifications** and the herein described modifications, additions or deletions.

### 6.3 Gravel Surfaced Streets and Alleys

Where excavation occurs in streets, alleys, or other areas which have only a gravel surface, such surfacing shall be replaced with gravel surfacing material equal in depth to that which existed before construction but not less than 3 inches compacted depth minimum. The surface shall conform to the original finish grade.

If the Contractor so elects, the existing gravel surfacing may be excavated down to a depth and width designated by the Project Construction Engineer, stockpiled in an area separate

from the excavated trench material, and later replaced to the required depth after the trench has been properly backfilled.

No separate measurement for payment will be made of any work or material stipulated above that is necessary to remove and later replace the gravel surfacing, and all costs incurred will be considered to be included in the unit price bid for the construction of the appropriate section of sewer line or the associated structure.

## **6.4 Sidewalk, Curb and Gutter, Concrete Pavement**

Where sidewalks, curb together, culverts and other obstacles are removed in the prosecution of the work. The Contractor shall consolidate the backfill in the same manner as specified for paved streets and shall then replace sidewalks curb and gutter, etc. in accordance with standard specifications for class of work involved. Where sod areas are encountered, the sod shall be removed and replaced with new at the original grade and elevation after consolidation of the backfill. Sprinkler systems shall be protected or removed and replaced as required.

## **6.5 Sod**

Sod, defined as densely grassed turf, which is removed, may be put back if it has been properly stored and remains in a healthy condition. If so stipulated in the Contract, the cost of replacing sod will be paid in the manner described under Measurement and Payment. If no pay item for replacing sod is included in the Contract, the Contractor shall consider that all costs incurred in replacing sod are to be included in the unit price bid for each section of sewer line or the associated structure.

## **6.6 Concrete Alley Pavement Replacement**

Except as modified herein, concrete alley pavement replacement over trench excavations shall conform to **Item 4** of the **Standard Construction Specifications**.

### **6.6.1 Materials**

The materials to be used for concrete alley pavement replacement shall conform to Item 20 Grass Sodding and the herein described modifications, additions or deletions.

- a. **Wire Mesh.** Reinforcing steel (6" x 6", W1.4 x W1.4) wire mesh shall be used for reinforcement of the concrete pavement over For replacement of full width alley concrete paving, the reinforcing steel wire mesh will extend the full alley width, per Wastewater Management Division Standard Detail S-205.
- b. **Concrete Aggregates.** Concrete shall conform to Paragraph 12.2, "materials", subparagraph b(2) of the Standard Specifications.
- c. **Joint Sealer.** Silicone joint sealer shall be a one part, low modulus, silicone formulation, designed for use in highway joint sealing applications and meeting Federal Specifications TT-S-001543A and TT-S-00230C. Primer shall be used if required by the manufacturer.

Acetic acid cure sealants are not acceptable.



Test methods shall be as follows:

Flow	MIL S 8802
Extrusion Rate	MIL S 8802
Track Free Time	MIL S 8802
Specific Gravity	ASTM D 792, Method A
Durometer Hardness	ASTM D 2240
Tensile Stress	ASTM D-412 (DIE C)
Elongation	ASTM D-412 (DIE C)
Ozone & Resistance	ASTM D-793-75

Bond to concrete mortar: Briquettes molded in accordance with AASHTO T 132-74 sawed in half and bonded with a thin section of sealant and tested in accordance with AASHTO T 132-74. Briquettes shall be dried to constant weight in oven at 110 degrees C+ degrees.

GESCS4403 Highway Joint Sealant and Dow Corning 888 Silicone Joint Sealant are approved for sealing joints. "Backer Rod" used in joints for Portland Cement Concrete Pavement shall be closed cell, polyethylene form rod conforming to the following specifications:

Diameter	Joint width + 1/78"	
Density	2.0 lbs./cu. ft.	ASTM D-1622
Tensile	15 psi	ASTM D-1623
Water Absorption	0.5% by volume	ASTM C-509
Compression Reflection	25% @ 8 psi	ASTM D-1621

## 6.6.2 Construction Requirements

### a. Alley Paving.

"Concrete driveways which abut the alley must be placed separately, creating a cold joint between the concrete driveway and the alley for the full depth of the alley paving."

### b. Expansion Joints.

"Expansion joints shall be placed at the end of block property lines and where the alley changes directions. Construction of the expansion joints will be as shown on the Wastewater Management Division Standard Details. Expansion joints shall also be required at structures, vaults, retaining walls, poles, etc. or as required by the Project Construction Engineer."

### c. Dummy Groove Contraction Joints. The Contractor has the option to use the dummy groove contraction joints as follows:

"All contraction joints will be saw cut as shown on the Wastewater Management Division Standard Details. The saw cut will be 1-1/2 inches deep by 3/8 inch minimum width to a maximum of 1/2 inch for the full width of the alley. Contraction joints will be spaced a maximum of fifteen (15) feet apart along the length of the alley and must be sawed consecutively in the direction of the pour. Only by approval of the Construction Project Manager may a joint be skipped and sawed later. Transverse contraction joints shall be placed at each utility pole, manhole, and at the ends of retaining walls, or as directed by the Project Construction Engineer. Contraction joints shall extend through any alley curbhead. Concrete joint sealer shall be a grey silicone joint sealant as manufactured by G.E., Dow-Corning or an approved equal. All joint sealers and backer rods shall be installed in accordance with the manufacture's requirements. The silicone shall meet all applicable AASHTO, ASTM and Federal Specification TT-S-0021543A and TT-S-00230C.

Saw cut joints to be sealed shall be filled with joint sealing material before the pavement is opened to traffic and as soon after completion of the curing period as is feasible. Just before sealing, each joint shall be thoroughly cleaned of all foreign material, including membrane curing compound, and joint faces shall be clean and surface-dry when seal is applied. Where cleaning of the joints is by compressed air, the compressed air shall be oil free. The sealing materials shall be applied to each joint opening in accordance with the details shown in the plans, to the manufacturer's specifications or as directed by the Project Construction Engineer. The joint filling shall be done without spilling material on the exposed surfaces of the concrete. Any excess material on the surface of the concrete pavement shall be removed immediately and the pavement surface cleaned. The use of sand or similar material to cover the seal shall not be permitted. Joint sealing material shall not be placed when the air temperature in the shade is less than 50 degrees F., unless approved by the Project Construction Engineer.

Should other cleaning methods prove unsatisfactory, the Construction Project Manager may require sandblasting or another method inside of the contraction joints to remove incompressible materials. The Contractor may wish to install the backer rod on top of the sawed joint in order to keep it clean and later depress the rod when the silicone sealant is installed. The joints shall be sealed by first priming the joint, if required by the silicone sealant manufacturer and then placing a backer rod compatible with silicone and sealing with an approved liquid silicone joint sealant. The joints should be approved by the Construction Project Manager prior to sealing."

- d. **Opening to Traffic.** Add the following after the first sentence of Paragraph 35.31: "Or until field-cured concrete cylinders have obtained a compressive strength of 3500 psi and all contraction joints have been cleaned and sealed."
- e. **Raised Lips.** No extra payment will be made for raised slope paving required to widen alleys to meet existing improvements shall be paid for as Concrete Alley Paving.
- f. **Finish.** As shown the plans, or where longitudinal slopes exceed 7%, or where required by the Project Construction Engineer, a 3/16 inch metal time finish shall be applied

perpendicular to the centerline in accordance with Colorado Department of Highway specifications.

**End of Specification**



CITY AND COUNTY OF DENVER  
ENGINEERING DIVISION

# Wastewater Capital Projects Management Standard Construction Specification

---

## 7.1 TUNNELING, JACKING AND BORING

### 7.1.1 Definitions

#### 7.1.1.1 Geotechnical Data Report (GDR)

A document which presents an interpretation of the known subsurface data for the project. The purpose of the GDR is to compile all geological, geotechnical, groundwater, and other data obtained from the geotechnical investigations for use by the various participants in the project. If available, this information will be included within the contract documents as specifically applicable to the project.

#### 7.1.1.2 Geotechnical Baseline Report (GBR)

The intent of a GBR is to clearly and contractually define the geotechnical conditions through which tunneling will occur in order to evaluate a differing site condition (if encountered) and it is used as a basis of bid for the contractor. By assessing the anticipated geotechnical conditions for a project and providing baselines in the contract, the contractor has a basis from which to prepare their bid and select their means and methods. The baseline conditions do not necessarily reflect the actual conditions; they are not geotechnical fact to be encountered. Rather, they represent the owner's assumption of existing geotechnical conditions for the project. If available, **this** information will be included within the contract documents as specifically applicable to the project. Regardless of inclusion, this information shall be investigated, interpreted, verified and/or developed by the contractor prior to commencement of the work.

#### 7.1.1.3 Tunnel Shield

A steel shell shaped to fit the excavation line of the tunnel that provides protection at the tunnel face for the construction personnel and space for the tunnel excavation and support operations. The shield may be fitted with boom-mounted tools such as an excavator for excavating the tunnel and mechanical devices for erecting the tunnel supports, or hand mining may be performed inside the shield.

#### 7.1.1.4 Tunnel Boring Machine (TBM)

A machine that uses a full-face cutter head to excavate a circular tunnel.

#### **7.1.1.5 Pipe Jacking**

The one-pass trenchless installation of a pipe by jacking the pipe behind a TBM or Tunnel Shield.

#### **7.1.1.6 Permeation Grouting**

The direct pressure injection of a chemical fluid grout into the ground to fill the spaces between and bind together soil particles, without causing excessive movement or fracturing of the soil formation. Permeation grouting is performed prior to commencement of tunneling operations to provide a more consistent and stable soil matrix. If applicable, the general extents of permeation grouting for a specific project may be shown in the plans.

#### **7.1.1.7 Compensation Grouting**

Compensation grouting is a grouting technique utilized to control ground settlement during soft ground tunneling. Compensation grouting involves the injection of a low slump mortar-like grout under high pressure to compact and displace the adjacent soils. The grout does not penetrate soil pores but displaces the subsurface soils by forming a homogeneous grout bulb near the grout pipe tip. Typically, compensation grouting is done after completion of tunneling to correct for settlement. Compensation grouting may also be performed concurrently with the progress of the tunnel while adjusted grouting parameters continually with reference to measured movements of the ground and/or surface structures, to keep settlement and deformations within specified limits.

#### **7.1.1.8 Contact Grouting**

The controlled injection of fluid grout at the interface between the pipeline and the ground to achieve continuous contact and fill the annular space, after pipe jacking has been completed.

#### **7.1.1.9 Inclinator**

An electronic probe lowered within a casing that senses changes in inclination along the casing axis. Inclinator are used to record the magnitude and depth of horizontal ground displacement. For tunneling purposes, they are typically installed adjacent to pit locations.

#### **7.1.1.10 Surface Monitoring Point**

A marker or point fixed to the ground surface and/or structures along a proposed alignment that is monitored by a professional land surveyor licensed in the state of Colorado using survey control to determine vertical and/or horizontal displacements that may occur during construction.

#### **7.1.1.11 Surface Monitoring Point Array**

A grouping or arrangement of surface monitoring points along the proposed tunnel alignment to determine vertical and/or horizontal displacements that may occur during construction.

#### **7.1.1.12 Deep Settlement Monitoring Point**

A sleeved rod installed to a specific depth, above the crown of the tunnel, which is used to detect ground movement directly above the tunnel. Also referred to as a single-point fixed borehole extensometer or Borros anchor.

## **7.1.2 Section Includes**

This item includes construction via tunneling, jacking and/or boring as shown on the Construction Drawings. The work includes: excavation of the tunnel, installation of carrier pipe, pipe, contact grouting around the pipe after tunneling, installation and monitoring of geotechnical instrumentation, disposal of excavated soils and compensation grouting as necessary during tunneling operations to control settlement to within acceptable limits. If the need for permeation grouting prior to starting the tunneling is anticipated, a separate bid item will be included within the contract documents.

## **7.1.3 Requirements**

The Contractor must adhere to all requirements contained with the Contract Documents, as well as access permits between the City and facility owners within the project limits.

A pre-excavation permeation grouting program shall be implemented prior to beginning tunnel excavation to improve ground behavior and reduce the potential for ground loss during tunneling. Requirements for this program are provided within these Standard Construction Specifications.

The Contractor shall determine tunneling and support equipment, materials, and methods subject to the limitations specified herein and elsewhere in the Construction Documents. It is the responsibility of the Contractor to safely construct the tunnel and provide the finished product within the requirements specified and shown. The Contractor shall design his tunnel means and methods to allow for performance of the work as specified herein.

The Contractor shall have the sole responsibility for maintenance and protection of existing utilities, railroad tracks, structures, and facilities within the zone of construction. Location of utilities shown on the Construction Drawings shall be considered approximate. The Contractor shall be responsible for locating each utility potentially impacted by the work to verify location prior to beginning the tunneling work.

The Contractor shall allow the Engineer, the City's Construction Project Manager, and the City's Project Management Team access to the shafts and tunnel.

## **7.1.4 Submittals**

### **7.1.4.1 Preconstruction**

Submit the following a minimum of 8 weeks prior to mobilization of tunneling equipment to allow for review by the City's Construction Project Manager and any other affected project stakeholders:

1. A detailed work plan including descriptions of methods and equipment to be utilized in completing the work, schedule for tunnel construction, and details of proposed tunnel construction procedures.
2. A detailed scale drawing showing tunnel layout, shaft locations and dimensions, equipment and staging areas.
3. Procedures for measuring excavation quantities versus forward progress during the tunneling operation.

4. A description and drawings of proposed methods and procedures for excavating the tunnel, including details for tunnel shield or TBM, breasting capabilities, method of controlling line and grade of the tunnel, and steering provisions for making line-and-grade corrections. Include details of provisions for supporting the face of the tunnel when tunneling operations are interrupted.
5. Contact grouting plans and procedures including: description of the grout system and grout equipment including grout pumps, mixers, delivery systems, and monitoring systems; number and spacing of grout holes; procedures for monitoring grout placement and controlling pressures; sequence of construction; grout material and properties; grout mix design including fluidizers, accelerators, and other additives; grout material properties including density, viscosity, bleeding, shrinkage, expansion, and set time.
6. Work plan and shop drawings showing: jacking frame and thrust block design, layout and details, including reaction transfer calculations. The thrust block backstop shall be normal (square) with the proposed pipe alignment and shall be designed to withstand the maximum jacking pressure to be used with a factor of safety of at least two, without excessive deflection or displacement.
7. Design calculations demonstrating that the pipe is capable of sustaining the maximum stresses to be imposed during jacking with a factor of safety of at least two. The calculations shall take into account: ground loads per the Geotechnical Data Report if available; live loads and surcharge loads from equipment; Cooper E80 loads; and jacking forces. Calculations to be performed and stamped by a professional engineer registered in the State of Colorado.
8. Submittal of a settlement control plan and applicable contingency plans prior to construction, including the proposed locations of surface monitoring points and arrays, deep settlement monitoring points, and inclinometers; equipment and materials to be used; and installation procedures.
9. Five days prior to commencement of grouting or construction of any kind, the contractor shall submit the installed location of all surface monitoring points, deep monitoring points and inclinometers. The Contractor shall submit drawings showing the surveyed location, the instrument identification number, the instrument type, the installation date and time, established elevations, initial elevations, offset and stationing, initial coordinates, boring logs, and the anchor to tip elevation and instrument length, when applicable.

#### **7.1.4.2 During Construction**

Written Daily Logs. The Daily Logs shall be recorded for each shift and shall be submitted to the City's Construction Project Manager within one working day of excavation at each location. As a minimum, the logs shall include the following:

- The station of the face of the excavation and advance distance;

- Length of pipe installed;
- The date, starting time, and finish time;
- Any unusual conditions, breakdowns, and delays;
- Excavated muck quantity;
- An accounting of volume of spoil in relation to the lineal foot advancement of the tunneling head
- Contact grouting performed;
- Results of pipe joint pressure testing; and
- Results of instrumentation monitoring.

## **7.1.5 Materials**

### **7.1.5.1 Tunnel Shield or Tunnel Boring Machine (TBM)**

The tunnel shield or TBM shall be designed to sustain ground loads which may be imposed upon it as well as any loads imposed by the thrust jacks, steering mechanisms, and other appurtenances. Tunnel excavation equipment shall be capable of maintaining a stable face in all expected ground conditions. The tunnel shield or TBM shall be steerable and capable of being controlled to the desired line and grade indicated on the Construction Drawings within the tolerances specified herein. Equip the tunnel shield or TBM with a laser control system to permit continuous and accurate monitoring of line and grade. The tunnel shield or TBM shall have suitable breasting tables, a closeable cutter wheel with flood doors, or such other appropriate provisions, as necessary, to support the tunnel face and minimize loss of ground. Mechanical or hydraulic excavators shall not interfere with breasting system or face support provisions. Excavator shall be capable of operation when fully retracted within the tunnel shield.

The tunnel shield or TBM shall have a propulsion system capable of moving the shield or machine forward while maintaining the construction tolerances with respect to line and grade. The propulsion system shall include a thrust ring or other provision that will distribute the jacking forces uniformly against the casing or jack pipe so the shield or machine can be advanced without damaging or distorting the pipe.

### **7.1.5.2 Contact Grout**

Contact grout shall be a stable colloidal suspension of cement, bentonite, water, fluidifier, and admixtures. Sand may be added, provided the grout is demonstrated to have suitable flow characteristics and to adequately fill the annular space between the pipeline and the ground being tunneled through.

The grout mix shall be the responsibility of the Contractor. The Contractor shall adjust the water-solids ratio of the grout as necessary to grout effectively and to fill all voids within the zone of grout influence; however, at all times the grout shall have a water-solids ratio of between 1:1 and 3:1 by volume, and a bentonite content of no more than two percent, and no hole shall be completed with a water-solids ratio above 1:1 by weight.

### **7.1.5.3 Pipe**



The pipe to be installed via tunneling shall be indicated within the plans and in accordance with the applicable portion of these Standard Construction Specifications.

#### **7.1.5.4 Casing Pipe, Spacers and End Seals**

Where tunneling operations are completed via boring and where specifically called out in the contract documents, a casing pipe, spacers and end seals shall be required.

The casing pipe shall be of welded steel pipe conforming to the requirements of ASTM A53 Grade B or AWWA C200, having minimum yield strength of 35,000 psi of the size and wall thickness as shown below or as otherwise noted in the Contract Documents. i.e. See wall thickness in Additional Notes ==→

Casing shall be kept on line and grade as required within this specification. Joints in the casing shall be field welded around the entire joint perimeter to produce a watertight seal. Welds shall be of a size to develop the full strength of the pipe materials.

Factory manufactured casing spacers shall be installed on all carrier pipes passing through a casing pipe. Wooden skids will not be allowed.

All casing spacers shall adhere and conform to the following:

1. All casing spacers shall be Model SSI8 or SSIM (field adjustable) for carrier pipes up to 24-inches in diameter and Model SSI12 for larger diameter carrier pipe sizes as designed and manufactured by Advance Products & Systems, Inc., Lafayette, LA., or an approved equal. The runners shall be at least 7-inches long for SSI8 and SSIM models or 11-inches long for SSI12 models and they shall be manufactured of high abrasion resistant, low coefficient of friction, glass filled polymer.
2. The casing spacers shall be center restrained to limit vertical movement of the carrier pipe in the casing.
3. Casing spacers shall be bolt-on-style with a shell made of at least two halves.
4. Spacing is approximately 3 per joint of pipe or 1 spacer per every 7 feet maximum.
5. The band material shall be manufactured of a minimum 14 gauge T-304 stainless steel and 10 gauge T-304 stainless steel risers when needed.
6. The casing spacers shall have a flexible PVC or EPDM liner having a minimum thickness of 0.090 inches with a hardness of Durometer "A" 85-90.
7. All welds are to be chemically cleaned and passivated.
8. All hardware shall be stainless steel.

After insertion of the carrier pipe into the casing, the ends of the casing shall be closed by installing  $\frac{1}{8}$ " thick synthetic rubber end seals such as the Model "AC" pull-on end seal, as manufactured by Advance Products & Systems, Inc., Lafayette, LA, or an approved equal. Ends seals shall be attached using minimum  $\frac{1}{2}$ " wide T-304 stainless steel bandings utilizing a worm gear mechanism.

## **7.1.6 Instrumentation**

### **7.1.6.1 Surface Monitoring Point Array**

Surface monitoring points shall consist of a stable non-destructive pin, nail, point, or other identifiable element with the locations clearly identified where the ground surface consists of sidewalk, curb, rail, or other structure. Where the ground surface consists of soil, vegetation, or ballast, the surface monitoring point shall consist of a minimum 1-foot long rebar anchor driven flush with the ground. The anchor shall be grouted in place. Each surface monitoring point shall have a tag or marking indicating the identification number, tunnel station, and offset from centerline.

### **7.1.6.2 Surface Monitoring Point Array**

The surface monitoring point array shall consist of multiple surface monitoring points installed and arranged in accordance with the Contractors submitted and approved work plan, and as outlined within these specifications.

### **7.1.6.3 Deep Settlement Monitoring Point**

Deep settlement monitoring points shall consist of a rebar anchor installed within a casing to a depth of 3 feet above the top of the tunnel, as shown on the Construction Drawings. Each point shall have a tag or marking indicating the identification number, tunnel station, and offset from centerline. Deep settlement monitoring points shall be installed in accordance with the Contractor's submitted and approved work plan and they shall be protected by traffic rated roadway boxes.

### **7.1.6.4 Inclinator**

Inclinometers are only required if specifically called out within the contract documents.

If required, they shall consist of inclinometer casing installed and grouted within vertical boreholes in the in situ soil. A probe, lowered within the casing, senses changes in inclination along the casing axis, and is used to calculate and monitor the magnitude and depth of horizontal ground displacements. Inclinometers shall be protected by roadway boxes.

Inclinometer casing shall be approximately 70 mm (2.75 in.) standard flush coupled such as Model No. 51150210 manufactured by Slope Indicator Company, Seattle; or approved equivalent.

Inclinometer Probe and Assembly. One inclinometer assembly shall be furnished including a sensor (probe) on a minimum 100 ft long cable, a pulley assembly, and a case. This equipment shall be Model No. 50302910 (sensor), and associated pulley assembly, and case manufactured by Slope Indicator Company, Seattle, WA or approved equivalent.

Inclinometer Readout Unit. Furnish one inclinometer readout unit. The readout unit shall be model No. 50310900 manufactured by Slope Indicator Company, Seattle, WA or approved equivalent. Readout unit provided shall be compatible with inclinometer probe and shall be calibrated to probe by manufacturer prior to shipment.

Inclinometer Software. Computer software required to reduce, analyze, and plot the inclinometer data using a compatible personal computer (PC) shall be furnished. Furnish Datamate Manager Software supplied by Slope Indicator Company, Seattle, WA or approved equivalent, or software compatible with other approved readout units.

Provide a cement-bentonite grout for installing inclinometer casing within drill hole. Grout mix shall be in accordance with manufacturer's requirements, and shall have up to 20 percent bentonite content by weight of cement; add enough bentonite to create a grout with a Marsh funnel number of 55 seconds.

### **7.1.7 Commencement of Work**

Do not begin tunneling until:

1. Required submittals have been reviewed and approved by the Engineer, applicable utility companies, and stakeholders.
2. A pre-construction meeting with the Engineer, City's Construction Project Manager, City's Project Management Team, applicable utility companies, stakeholders and Contractor has been conducted.
3. Shaft excavation and support have been satisfactorily completed in accordance with the Contract Documents.
4. Permeation grouting has been satisfactorily completed in accordance with the Contract Documents.
5. All instrumentation has been installed and initial measurements have been obtained

### **7.1.8 General Tunneling Requirements**

Conduct all operations such that trucks and other construction vehicles do not create a dust nuisance in the streets and adjacent properties. All work shall be done so as not to disturb railroad tracks, roadways, adjacent structures, landscaped areas, or utilities other than as shown on the Construction Drawings. Any damage shall be immediately repaired to the satisfaction of the property owner, residents, agency or utility having jurisdiction, and the City at no additional cost to the City.

No gasoline-powered equipment shall be permitted. Diesel, electrical, hydraulic, and air powered equipment is acceptable, subject to applicable City, State, and Federal regulations. There will be no classification for excavated materials and the term "excavation" shall include all materials excavated or removed from the tunnel, regardless of the type, character, composition or condition of the material so excavated.

The tunnel shall be excavated to the lines, grades and dimensions required to ensure installation of the pipeline as indicated on the Construction Drawings. The tunnel excavation shall begin at the downstream end and work upstream unless approved otherwise.

Methods of construction for the tunnel shall ensure the safety of the work, the Contractor's employees, the public, and adjacent property, whether public or private. Perform all work in accordance with all current applicable permit conditions, regulations, and codes of federal, state, and local agencies. Comply with all applicable provisions of 29 CFR Part 1926, Subpart S, Underground Construction by OSHA. Comply with standards and guidelines provided by the American Railway Engineering and Maintenance-of-Way Association (AREMA), as applicable to the work. In the event of conflict, the strictest or most restrictive shall govern.

### **7.1.9 Tunnel Construction**

Tunnel excavation shall be performed in a manner that will minimize movement of the ground in front of and surrounding the tunnel, and to minimize loss of ground, surface settlement, heave of the ground surface, and movement of railroad tracks, structures, and utilities above and adjacent to the tunnel. The Contractor shall ensure that movement (settlement or heave) at the ground surface does not exceed 0.25-inches, unless noted otherwise within the contract documents.

Support the ground continuously and in a manner that will prevent loss of ground and maintain the stability of the tunnel perimeter and face. Support the tunnel face by positive means during all shut down periods.

Maintain clean working conditions at all times inside the tunnel, and remove all excavated soil (muck), grout spills, and any other material not required for tunneling. All construction debris shall be removed from the site and disposed of daily by the Contractor at the disposal site designated elsewhere in the Construction Documents.

Provide all temporary electrical, water, telephone, and other facilities required to complete the tunnel.

Provide access for Engineer, City's Construction Project Manager and City's Project Management Team to inspect and observe the work or to perform independent line and grade surveys.

Perform tunneling work in accordance with the working hours established for the project. In case of emergency or work stoppages likely to endanger the stability of the excavation or adjacent structures, maintain a full work force 24 hours per day, including weekends and holidays, until emergency or hazardous conditions no longer jeopardize stability and safety of the work.

### **7.1.10 Tunnel Line and Grade**

The longitudinal centerline of the tunnel shall be sufficiently true and accurate to the tunnel profile grade line to stay within the following tolerances during and upon completion of tunneling: invert of the pipe shall be within 1.5 inches horizontally and 1 inch vertically of the plan line and grade. Survey the pipe invert upon every advancement of the pipe to ensure the elevation and alignment is within the tolerances specified above.

Pipe installation shall be invert elevation controlled and reverse grades are prohibited. Deviations from the design tunnel invert shall not exceed the tolerances specified above at

any point during construction and corrections shall not exceed a rate of 3 inches per 100 feet or a lesser rate as determined by the structural characteristics of the pipe.

If the Contractor is unable to maintain these tolerances, he shall bear the full responsibility and expense for correction (redesign, easement acquisition, retunneling, etc.). If design tolerances are exceeded and redesign is required, the Contractor shall obtain the services of a professional engineer registered in the State of Colorado for the redesign. Plans showing the changes shall be submitted to the Engineer for review and approval.

### **7.1.11 Pipe Jacking**

Immediately before joining pipe, the end of the pipe shall be thoroughly cleaned and lubricated with an approved lubricant. The axial forces from the thrust jacks shall be distributed to the pipe uniformly to prevent damage to the ends of the pipe, using pipe cushioning in accordance with approved submittals.

If any part or parts of the pipe becomes unserviceable because the pipe is chipped, gouged, or otherwise damaged before or during installation, it shall be rejected and removed from the site. The City's Construction Project Manager shall make the final determination on rejection and removal of the pipe.

After pipe installation is completed, individual joints shall be pressure tested with a portable hydrostatic tester to 13 psi, in lieu of line infiltration, exfiltration, or air testing.

### **7.1.12 Contact Grouting**

The annulus between the pipe and the ground shall be grouted after pipe jacking is completed. Grouting shall be performed over the entire 360° circumference of the tunnel. The number and location of grout holes in each pipe shall be determined by the Contractor but a minimum of six holes per 20-foot pipe section shall be used. Rings of grout holes shall be spaced at intervals of six feet or less.

Grout shall consist of Portland cement and water or of Portland cement, sand, and water. Grout mixtures may contain bentonite or fly ash. The grout shall consist of 2 parts Portland cement, 1 part fly ash, and not to exceed 6 parts clean, dry, sand.

Contact grout shall be free of lumps when put into the mixer, and the grout mix shall be constantly agitated. Grout shall flow unimpeded and completely fill all voids. Perform the injection of grout continuously on any one pipe section. Fill spaces and voids until completed, so as to avoid disturbance of grout which has taken an initial set.

The grouting process shall be so operated and controlled that the grout will be delivered uniformly and steadily. If, during the grouting of any pipe, grout is found to flow from adjacent grout pipes, such pipes from which grout is flowing shall be closed with valves or plugged with wooden plugs. Where such closing is not essential, ungrouted pipes shall be left open to facilitate the escape of air and water from the space being grouted.

Grouting shall progress from grout pipe to grout pipe in accordance with approved submittals. In going from lower to higher grout pipes, do not make connections to the higher grout pipes until the grout has completely filled the space below the higher grout

pipes. As the grouting proceeds, the escape of grout from the upper pipes in turn shall be permitted as an indication of successive satisfactory filling of voids with grout.

Protect and preserve the interior surfaces of the pipe from damage. Minimize grout drop and proceed with cleanup immediately after grouting. Any damage to the pipe caused by or occurring during the grouting operations shall be repaired. The interior lining of the pipe shall be smooth and free from defects.

Maintain and submit records of grouting operations for each shift, including the location and a detailed log of each grout hole, time of each change of grouting operations, pressures, rates of pumping, grout mix, and grout take at each grout hole hook-up.

After grouting, holes shall be filled with dry packed cement mortar grout. Threaded plugs shall be installed flush with the inside face and the remaining void shall be filled with a non-shrink grout rated to 4000 psi.

### **7.1.13 Installation of Instrumentation**

Instrumentation shall be installed at the locations shown on approved shop drawings. Instruments shall be installed in accordance with the approved installation schedule. All instruments shall be clearly marked, labeled, and protected to avoid being obstructed or otherwise damaged by construction operations, the general public, or railroad operations.

Locate conduits and underground utilities in all areas where subsurface geotechnical instrumentation is to be drilled and installed. Subsurface geotechnical instrumentation locations shall be modified, as approved by the City's Construction Engineer, to avoid interference with existing conduits, railroad tracks, utilities, and foundation elements. Repair damage to existing utilities resulting from instrument installations at no additional cost to the City.

Surface monitoring points and arrays shall be installed over the centerline of the tunnel and at offsets as shown in the Contractor's approved submittals to determine the lateral and longitudinal extent of ground movement. The longitudinal spacing of the points shall be a minimum of one every 25 feet along tunneled portions of the project, as allowable based on surface features. The longitudinal spacing of the arrays shall be a minimum of one every 75 feet along tunneled portions of the project, as allowable based on surface features. The arrays shall be centered across the proposed tunnel(s).

Individual surface monitoring points shall be placed along each side of each shaft, a distance of 5 feet and 10 feet from the shaft wall; a minimum of 6 points per shaft shall be installed.

Deep settlement monitoring points shall be installed in accordance with approved shop drawings. The bottom of the instrument shall be located 3 feet above the crown of the tunnel.

Immediately following installation, the location of the top of all instruments shall be surveyed to provide horizontal and vertical coordinates. Data shall be provided to the City's Construction Project Manager in accordance with the submittal requirements specified herein. Re-surveying from control points shall be required a minimum of every two weeks or more frequently as required to address potential disturbances or resolve conflicting data.

**7.1.14 Installation of Inclinometers**

Inclinometers, if required within the contract documents, shall be installed within 5 feet of each shaft as shown on the plans and/or as approved in the submitted shop drawings. Inclinometer casing shall extend from the ground surface to a depth at least 15 feet below the base of the shaft excavation.

Conduct drilling operations using appropriate methods that are consistent with geologic conditions presented in the Geotechnical Baseline Report. Provide drill casing if required to hold drill hole open. Drill hole or inside of casing, if applicable, shall provide a clear opening (6 inches) in diameter or greater. A log of the soils encountered during drilling shall be accurately maintained, and a copy shall be provided to the City’s Construction Project Manager in accordance with the time restrictions stated herein.

Install inclinometer casing in accordance with the manufacturer’s recommendations and approved shop drawings. Grout the annulus between the inclinometer casing and the ground using a non-shrink cement grout.

Install protective housing with locking cap and padlock. Protective housing shall be installed within an approved flush-mounted traffic rated roadway box or vault so as not to obstruct vehicle or foot traffic.

**7.1.15 Instrumentation Monitoring and Reporting**

The Contractor shall take initial readings of all instruments to establish a baseline and provide the City’s Construction Project Manager with this data, in accordance with the requirements specified herein. The Contractor will read required instrumentation and provide the City’s Construction Project Manager with these data. Surface monitoring points and arrays and deep settlement monitoring points within 50 feet of the working face of the tunnel shall be surveyed daily. Inclinometers shall be monitored daily. The frequency of monitoring may be modified by the Engineer or the City’s Construction Project Manager.

The Contractor shall provide data from readings of all instruments to the City’s Construction Project Manager within one working day of obtaining the information. The data shall include a copy of the data sheets containing a cumulative history of readings, including weather conditions, temperature, and proximity of the excavation to the instrument location itself, at the time of each reading.

The Contractor shall abide by the following Response Values:

<b>Instrument</b>	<b>Threshold Value</b>	<b>Shutdown Value</b>
Surface Monitoring Points and Arrays	1.5-inch H or V for Shafts 0.13-inch H or V for Tunnels	3-inch H or V for Shafts 0.25-inch H or V for Tunnels
Inclinometer	1.5-inch H or V for Shafts	3-inch H or V for Shafts
Deep Settlement Monitoring Points	2-inch V	4-inch V

If a threshold response value is reached, the Contractor shall meet with the City's Construction Project Manager to discuss his/her means and method to determine what changes, if any, shall be made to better control movement. If a shutdown response value is reached, the Contractor shall stop all work immediately. The Contractor shall meet with the City's Construction Project Manager, the Engineer, and the City's Project Management Team to develop a plan of action before work can be resumed. All costs associated with shutdown due to reaching maximum limits shall borne by the Contractor.

Remove all instrumentation during the cleanup and restoration work or as required by the City's Construction Project Manager. All roadway boxes shall be removed. At a minimum, fill the inclinometer casing and deep settlement point casing with a lean cement grout and cut off the upper 3 feet of the instrument and casing which extend below grade.

#### **7.1.16 Cleanup and Restoration**

Remove all equipment, unused materials, and debris from the site at the end of the job. Restoration shall follow construction as the work progresses and shall be completed as soon as possible and to the satisfaction of the applicable utility owners and stakeholders. Restore and repair any damage resulting from surface movement caused by the work. Any property or improvements damaged or destroyed, shall be restored to a condition equal to or better than existing prior to construction at no additional cost to the City. Restoration shall be completed immediately if a third party or the City is inconvenienced by the damage, and in no case later than thirty (30) days after the damage is discovered. This provision for restoration shall include all property which was affected by the construction operations.

**END OF SPECIFICATION**





CITY AND COUNTY OF DENVER  
ENGINEERING DIVISION

## Wastewater Capital Projects Management Standard Construction Specification

---

### 7.2 MICRO TUNNELING

#### 7.2.1 General

Where indicated on the Drawings, or where field conditions dictate that open trenching for the pipeline across railroad tracks, highways, or other obstructions is prohibited, the pipe shall be installed by jacking, tunneling, boring and casing methods, or micro tunneling.

Should the General Contractor, in the process of Project construction, elect to propose that a portion of the pipe be installed by micro tunneling, rather than by jacking, boring or trenching operations, the subject cost shall not total more than the aggregate sum of the removal and replacement costs that such an activity would replace.

#### 7.2.2 Shop Drawings

Detailed shop drawings will be required for all pipe jacking, tunneling and boring installations.

#### 7.2.3 Construction

Work specified in this Section describes the construction of sanitary sewers by jacking fiberglass reinforced polymer mortar (RPM) behind a remotely operated, steerable, micro-tunneling boring machine (MTBM), with RPM serving as both the primary tunnel liner during construction and sanitary sewer pipe (secondary tunnel liner) after completion of construction. The General Contractor shall select and utilize methods and equipment compatible with the selected dimensions of the tunnel and with the anticipated geologic conditions described in the Geotechnical Report (GR).

The micro-tunneling boring machine (MTBM) may be either of the following:

##### 1. Slurry Shield

An MTBM in which the tendency of soil at the excavation face to run or flow uncontrollably into the MTBM is prevented by the counterbalancing force of bentonite slurry contained at the face of the MTBM. During boring, the excavated material is mixed with the bentonite slurry and pumped through a pipe for disposal.

##### 2. Earth Pressure-Balance Shield

An MTBM in which the tendency of the soil at the excavation face to run or flow uncontrollably into the MTBM is prevented by the counterbalancing force of the excavated material which is contained, under pressure, at the face of the MTBM. During boring, the excavated material is mixed with water or bentonite slurry and pumped through a pipe for disposal or by a balanced screw auger or screw conveyor system.

During tunneling and construction operations, the following shall be followed:

- a. Control groundwater in accordance with specified requirements during all micro-tunnel excavation.
- b. Perform micro-tunneling operations in a manner that will minimize loss of ground and minimize settlement of the ground surface, structures, and utilities above and adjacent to the tunnel.
- c. The General Contractor shall perform pre-construction and post-construction surveys of all structures, residences, and other facilities adjacent to the areas of the tunnel.
- d. Maintain clean working conditions at all times inside the tunnel and pits. All muck, slush, grout spills, ponded water, and any other material not required for tunneling shall be removed from the excavations in a timely manner.
- e. All work of excavating, lining, grouting and construction of the jacking operation shall be so executed that ground settlement or loss will be minimized; the completed sewer pipe shall have full bearing against earth, and no voids or pockets will be left in any portion of the Work. The peripheral space between the support elements and the excavated surface (i.e., the diameter of the excavated hole is no larger in diameter than 3/4 inch more than the pipe outside diameter) shall be filled with the bentonite lubricating material. If the diameter of the excavated hole is greater than 3/4 inch more than the outside diameter of the pipe, it shall be promptly filled with suitable material, such as grout, as accepted by the Construction Project Manager. This may require jacking or the pipe be discontinued and additional access pits installed at no extra cost to the City.
- f. The General Contractor shall be aware that various existing soil borings, piezometers or instrument wells coincide with the proposed sewer pipe alignment. These may or may not have been backfilled with grout and therefore caution should be used in tunneling through these existing borings. General Contractor shall take mitigating measures at no additional cost to the CITY to counter any effect these bore holes, piezometers or instrument wells may have on tunneling operations.
- g. All excavations shall remain within the easements and rights of way indicated on the Drawings, to the lines and grades designated on the Drawings, and use methods which include due regard for safety of workmen, adjacent structures, utilities, and the public. Methods of excavation shall be at the General Contractor's option, subject to the review of the Construction Project Manager. Shape the excavation to

fit the sewer pipe section and of sufficient size to allow the construction of the sewer pipe to the lines and grades indicated on the Drawings.

### **7.2.3.1 Casing Pipe Installation Method**

The General Contractor shall have the option to select the method of micro-tunneled casing pipe installation, subject to approval by the Construction Project Manager.

The excavated size of the tunnel shall be determined by the General Contractor based on construction requirements for the secondary lining system, and is subject to the limitations shown on the Drawings.

### **7.2.4 References**

All work shall be performed in accordance with applicable regulations of all federal, state, and local regulations, codes, and standards.

### **7.2.5 Existing Conditions**

#### **7.2.5.1 Restrictions**

The General Contractor shall comply with all restrictions set as conditions under which the easement or permission was granted to the Owner to perform the work of this Contract. These restrictions are included with these Specifications. The General Contractor is presumed to have fully determined all special requirements that pertain to each length of sewer in tunnel constructed under this Section.

#### **7.2.5.2 Preliminary Inspections**

The General Contractor shall inspect the locations where the access pits and tunnels are to be built to familiarize himself with the conditions under which the Work will be performed and with all necessary detail as to the orderly prosecution of the work in conformance with Instructions for Bidders. The omission of any details necessary for the satisfactory prosecution of the WORK in its entirety, which may not appear herein, shall not relieve the General Contractor of his full responsibility.

#### **7.2.5.3 Soil, Rock and Groundwater**

The General Contractor acknowledges that certain soils reports, borings, and other Geotechnical data, more particularly described or referenced in the Standard Construction Specifications of the Contract, have been made available for inspection and review. The borings were made for the use of the City in the design of the Project and are not intended to be interpreted for use in temporary construction facilities designed by the General Contractor.

#### **7.2.5.4 Utilities**

The General Contractor shall be responsible for the protection of all utilities encountered during the Work of this Contract. The known utilities are shown on the Contract Drawings and the General Contractor shall take every precaution when working near the utility to locate and protect these utilities. All damage to the existing utilities shall be the sole

responsibility of the General Contractor. The General Contractor shall replace, repair, remedy, or compensate for all damages at no additional cost to the Owner.

#### **7.2.5.5 Structures**

The General Contractor shall be responsible for the protection of all structures, roads and railroads above or adjacent to the tunnel, within the framework and criteria set forth in the Contract Documents.

#### **7.2.6 Definitions**

##### **1. Micro Tunneling**

Shall be defined as a method of installing pipe, by jacking the pipe behind a remotely controlled, steerable, guided articulated Micro-Tunneling Boring Machine (MTBM). The MTBM, which is connected to and followed by the pipe being installed, shall ensure that the soils being excavated are fully controlled at all times.

##### **2. Jacked Pipe**

Shall be defined as the General Contractor's sewer pipe that serves as initial construction lining and tunnel support, installed by the General Contractor for stability and safety during construction, and as the sewer line or permanent secondary liner.

##### **3. Jacking System**

A system of jacks which pushes the sewer pipe. Capacity of jacks and extension rate is synchronized with excavation rate of the machine.

##### **4. Intermediate Jacking Station**

Hydraulic jacks installed at intermediate locations in the pipe string to allow selective shoving of discrete segments of the total pipe.

##### **5. Slurry System**

Transportation of excavated material in slurry flow matched to excavation rate. System balances groundwater pressures and separates soil from slurry at end of process. Soil separation methods are not limited to mechanical means. Soil separation method may be chemical in nature.

##### **6. Laser**

An optical system projecting a beam to a target to provide guidance for the micro-tunnel excavation.

##### **7. TV**

A television system which monitors the progress and alignment of the micro-tunneling machine and pipe.

##### **8. Controls**

The system which synchronizes excavation, removal of the excavated material, and jacking of pipe to maintain overall balance to provide complete and adequate ground support at all times.

## **7.2.7 Quality Assurance**

### **7.2.7.1 General Contractor**

The General Contractor must provide proof of successful experience with micro tunnel excavation and support at the depths shown, in the soil and groundwater conditions expected, with the lining systems shown and with the General Contractor's proposed equipment.

### **7.2.7.2 Project Superintendent**

The project superintendent shall have at least five years of tunneling experience and shall have worked on at least two micro-tunneling projects in similar ground conditions using equipment similar to the equipment required for this project. The machine operator shall have at least three years of micro-tunneling experience and shall have worked on at least one tunnel project using the same equipment required for this project.

## **7.2.8 Quality Control**

General Contractor shall establish and maintain quality control for operations under this Section to assure compliance with contract requirements and maintain records of his quality control for materials, equipment, and construction operations including but not limited to the following:

### **7.2.8.1 Preparatory Inspection**

Preparatory inspection shall be conducted prior to commencing work and should include the following as a minimum requirement:

1. Check pipe for conformance to approved certified tests.
2. Check pipe for proper storage and handling.
3. Discuss and review pipe installation procedure with the Construction Project Manager. Discussion shall include placement of pipe, joint preparation and application of each pipe used.

### **7.2.8.2 Initial Inspection**

Initial inspection shall be conducted after a representative sample of the work is complete and should include the following as a minimum requirement.

1. Check for proper depth and grade for pipe.
2. Check method of joining pipes.
3. Check the pipe for proper alignment.

## **7.2.9 Tolerances**

Excavation and jacking of the sewer pipe shall be controlled by the General Contractor to allow construction of the sewer to a true circular shape and to within 1.5 inches on line and 1 inch on grade. Variations from line and grade tolerances listed herein may be allowed

provided the line and grade variation is regular and only in one direction, and that the final grade of flow line is in the direction indicated on the Drawings. When the excavation is off line and grade, the General Contractor shall make corrections to plan line and grade at the rate of 3 inches per 100 feet.

The General Contractor shall survey the tunnel at 50-foot intervals or a minimum of once per tunnel drive to ensure the alignment is within the tolerances specified. The survey shall be conducted immediately behind the tunnel excavation to allow immediate correction of misalignment. Tunnel excavation shall not precede surveyed verification of the alignment by more than 100 feet, or more frequently if line and grade tolerances have been exceeded. The tunnel guidance system may be used; however, the General Contractor shall select times to measure and record this information after the air temperatures have stabilized throughout the pipe to ensure accurate readings.

If the General Contractor is unable to maintain these tolerances, he shall bear full responsibility and expense for correction (redesign, easement acquisition, etc.) If these tolerances are exceeded and redesign of structures is required, the General Contractor shall obtain the services of an independent professional engineer registered in the State of Colorado for the redesign. Plans showing the changes shall be submitted to the Construction Project Manager for review.

#### **7.2.10 General Contractor Submittals**

The Construction Project Manager will base the review of submitted details and data with consideration of requirements for the completed work, utilities, and the possibility of unnecessary details in the execution of the work to be constructed under this Contract. Review of the General Contractor submittals by the Construction Project Manager shall not be construed in any way as relieving the General Contractor of his responsibilities under this Contract.

The General Contractor shall submit the following to the Construction Project Manager for approval and/or examination:

##### **1. Working Drawings**

Complete working drawings showing details of the proposed method of construction and the sequence of operations to be performed during construction shall be submitted. Working drawings shall show the method of micro-tunneling, including the micro-tunneling system to be used, location of access pits including method of excavation, shoring and bracing appurtenance installation, and dewatering techniques that are proposed to be used. The following shall be included as the minimum level of detail required:

- a. A detailed description of the micro tunneling procedure including construction techniques to provide the access required to install pipe in conformance with the Contract Documents.
- b. Manufacturer's literature describing in detail the micro-tunneling system to be used. Detailed description of projects on which this system has been successfully used

- including the names, addresses and telephone numbers of owner's representatives for these projects as well as length, diameter, and pipe material used.
- c. Calculations and drawings indicating limits of access pits and any ground support to be utilized.
  - d. Method of spoils disposal.
  - e. A groundwater stabilization scheme covering the excavations for starter and receiver pits. Verify this plan to stabilize anticipated unstable soil conditions. Such verification shall include all calculations and detail drawings for methods of controlling groundwater.
  - f. Certification by the machine manufacturer of the thrust, torque, condition, and operational characteristics of all equipment to be used for installing the specified pipes. The micro-tunneling equipment shall employ a spoil removal system with a pressure balance system that is capable of equalizing pressures between the tunnel face and the micro-tunneling machine head in order to prevent caving beyond the outside diameters of the pipe.
  - g. Layout of tunneling and ancillary equipment at each jacking and receiving (access) pit location.
  - h. Tunnel machine shop drawings including configuration of cutter head and over cut.
  - i. Ventilation system details.
  - j. Pipe lubrication system details.
  - k. Electrical system and lighting details.
  - l. Grade and alignment control system details.
  - m. Tunneling machine groundwater control provisions.
  - n. Gas monitoring system.
  - o. Details of mucking system and soil separation methods including proposed slurry formulations and calculations of the system capacity to handle flows at all distances and changes of elevation to and from the tunnel machine.
  - p. Details of jacking system, intermediate jacking stations and their proposed spacing, method of operation, and thrust capacity. Include calculations of anticipated jacking forces required to advance the pipe. Include sleeve details and supporting gasket compression calculations for joints and gaskets used with intermediate jacking stations. Describe controls to prevent the maximum jacking force from being exceeded.
  - q. Details of grouting the annulus space after pipe has been installed including injection pressure and method of controlling grout pressures.
  - r. Grouting techniques to be used for over excavation if any, including equipment, pumping procedures, pressure grout types and mixtures.

- s. Procedures for measuring excavation quantities versus forward progress during the tunneling operation.
- t. Calculations demonstrating that the pipe selected has been designed to support the maximum anticipated earth loads and superimposed live loads, both static and dynamic, which may be imposed on the pipe. Determine the additional stresses imposed on the pipe during jacking operations and upgrade the quality and strength of the pipe and pipe joints to the extent necessary to withstand the additional stresses imposed by the jacking operation. The details shall be submitted for approval.
- u. Complete information on General Contractor's safety plan for personnel conducting the micro-tunneling operations and appurtenance installation. The plan shall include provisions for lighting, ventilation, and electrical safeguards.
- v. Keep and maintain at the construction site a complete set of field drawings for recording as-built conditions. It shall have marked or noted thereon all field information, properly dated, recording as-built conditions. This set of field drawings shall be kept up to date.
- w. Pipe certification of compliance.
- x. Pipe jointing methods and details.
- y. All General Contractor submittals requiring structural design shall be signed by a professional civil or structural engineer registered in the State of Colorado.
- z. Written documentation summarizing the qualifications of the project superintendent, machine operators, and site safety representative.

## **2. Log of the Jacking Operations**

The General Contractor shall submit a log of jacking operations; the log shall be taken at intervals of no more than 10 minutes apart and a minimum of four readings per pushed 10 foot and accomplished by digital video recording of the TV image at the operator's console. Video shall show a real-time clock that matches the time scale used in the log. Indicators in the tunneling machine being viewed by the digital recorder shall indicate when the tunneling machine is excavating and the number of the pipe joint that is being pushed. The log shall be submitted to the Construction Project Manager each day. The digital video shall be submitted to the Construction Project Manager each week. As a minimum, the log shall consist of the following:

- a. The position of the tunneling machine in relation to the design line and grade.
- b. The jacking forces exerted on the pipe at each jacking station.
- c. The date, the starting time, and the finish time.
- d. The position of the steering jacks.
- e. Inclination.
- f. Cutter head torque.



- g. Slurry flow rates in both the supply and return lines (if slurry is used).
- h. Face pressure.
- i. Hydraulic pressure (on hydraulic motor machines).
- j. LEL gas readings.

### **3. Pipe Lubricant**

Submit a separate log tracking pipe lubricant used in gallons, its viscosity, and pumping pressure. Log shall be submitted to the Construction Project Manager each day

### **4. Muck Removal**

Submit a separate log tracking the volume of muck removed from the site. Log shall be submitted to the Construction Project Manager each day.

### **5. Survey Records**

Submit survey records of the horizontal and vertical positions of surface control points and other instrumentation within 24 hours of measurements as required herein.”

### **6. Inclinator Data**

Inclinometer data shall be plotted on a cumulative time-deflection plot, using commercial software from the manufacturer, with past readings shown together with most current so that trends can easily and quickly be established by the Construction Project Manager and General Contractor.

## **7.2.11 Products**

### **7.2.11.1 Equipment**

No gasoline powered equipment shall be permitted in the tunnel operation. Diesel, electrical or air-powered equipment will be acceptable, subject to applicable federal and state regulations. Diesel engines equipped with scrubbers are acceptable only when jacking in free air. Provide compressed air and electricity for General Contractor’s operations from a source outside the pipe.

#### **1. Micro Tunnel Boring Machine (MTBM)**

The General Contractor shall employ MTBM that is capable of handling the various anticipated ground conditions. In addition, the MTBM shall:

- a. Have a “closed” face which is capable of minimizing loss of ground ahead of and around the machine and providing satisfactory support of the excavated face at all times and shall have the capability of setting a calculated earth balancing pressure and positively measuring the earth pressure at the face.
- b. Provide a system to indicate whether the amount of earth material removed is equivalent to that displaced by the advance of the machine such that the advance rate may be controlled accordingly.
- c. Conform to the shape of the tunnel with a uniform perimeter that is free of projections that could produce over excavation or voids.
- d. Be articulated to enable remote steering of the system.

- e. Have a display available to the operator, at an operation console, showing the position of the shield in relation to a design reference together with other information such as face pressure, roll, pitch, steering attitude and valve positions.
- f. Incorporate a seal in the tail of each MTBM shield to prevent leakage of lubricating liquid or grout, into the tunnel space, between the MTBM shield and lining.
- g. Have a cutter head powered by electric or hydraulic motors and have motors and operating controls protected against water inflows.
- h. Provide a bi-directional drive on the cutter head wheel.
- i. Provide means for maintaining the tunnel face under wet and adverse soil conditions. Use closure doors on the cutter wheel or other means acceptable to the Construction Project Manager.

## **2. Automated Spoil Transportation**

The General Contractor shall provide a MTBM which includes an automated spoil transportation system which shall:

- a. Match the excavation rate to the rate of spoil removal thereby maintaining settlement or heave within tolerances specified.
- b. Balance ground water pressures by the use of a slurry pressure balance system which shall be capable of any adjustment required to maintain face stability for the particular soil condition encountered on the Project and shall monitor and continuously balance the ground water pressure to prevent loss of slurry and or ground water.
  - In a slurry spoil transportation system the ground water pressure shall be managed by use of the slurry pumps, pressure control valves, and a flow meter.
  - A slurry bypass unit shall be included in the system to allow the direction of flow to be changed and isolated, as necessary.
  - A separation process shall be provided when using the slurry transportation system which shall be designed to provide adequate separation of the spoil from the slurry so that the clean slurry can be returned to the cutting face for reuse. Spoil shall be appropriately contained at the site prior to disposal.
  - The type of separation process used shall be dependent upon the size of the tunnel being constructed, the soil type being excavated, and the work space available at each work area for erecting the plant.
  - The composition of the slurry shall be carefully monitored for specific gravity and viscosity.
- c. Balance ground water pressures by the use of an auger earth pressure balance system which shall be capable of any adjustment required to maintain face stability for the particular soil condition to be encountered on the Project and shall monitor and continuously balance the ground water pressure to prevent loss of ground water.

- If an auger spoil transportation system is utilized, the ground water pressures shall be managed by controlling the volume of spoil removal with respect to the advance rate (Earth Pressure Balance Method) and the application of compressed air. The speed of rotation of the auger flight, the addition of water, and/or compressed air shall be monitored.
- The Construction Project Manager's approval will be required where an auger soil transportation system is proposed for use by the General Contractor in the presence of ground water. Such approval will be based on an evaluation of the equipment's ability to balance soil and water pressures at the face, stability of the soils, and the significance of the ground water present.

### **3. Pipe Jacking Equipment**

The General Contractor shall provide a MTBM which includes a pipe jacking system which shall:

- a. Have the main jacks mounted in a jacking frame located in the starting pit.
- b. Have a jacking frame which shall successively push the MTBM along with a string of connected pipes toward a receiving pit.
- c. Have sufficient jacking capacity to push the MTBM and the string of pipe through the ground.
  - Calculations shall be made to determine the face excavation forces, frictional factor, and weight of the MTBM and pipes.
  - The jacking equipment installed must have a capacity at least 20 percent greater than the calculated theoretical jacking load.
- d. Have hydraulic cylinder extension rates which are synchronized with the excavation rate of the MTBM, which shall be determined by the soil conditions.
- e. Have intermediate jacking stations which shall be provided when the calculation of the total jacking force needed to complete the installation exceeds 80 percent of the capacity of the main jacks or the designed working compressive loads (including safety factor) allowed for the pipe.
- f. Develop a uniform distribution of jacking forces on the end of the pipe by use of spreader rings and packing.
- g. Provide for a pipe lubrication system which shall be used if the calculated jacking forces are expected to exceed the pipe design strength (including the 2.5 to 1 safety factor) or if the actual jacking forces encountered exceed 80 percent of the pipe design strength (including the 2.5 to 1 safety factor). Should either of these conditions occur, an approved lubricant shall be injected to lower the friction developed on the surface of the pipe during jacking.

### **4. Remote Control System**

The General Contractor shall provide a MTBM which includes a remote control system which shall:

- a. Allow for the operation of the system without the need for personnel to enter the micro-tunnel. In man entry sized pipes, intermittent entry of personnel will be permitted for maintenance and removal of equipment once the pipe installation is complete, provided that all safety precautions specified elsewhere and required by law are in place and functional.
- b. Integrate the system of excavation and removal of soil and its simultaneous replacement by pipe. As each pipe section is jacked forward, the control system shall synchronize all of the operational functions of the system.
- c. Provide complete and adequate ground support at all times.

## **5. Active Direction Control**

The General Contractor shall provide a MTBM which includes an active direction control system which shall:

- a. Control line and grade by a guidance system that relates the actual position of the MTBM to a design reference (e.g., by a laser beam transmitted from the jacking pit along the center line of the pipe to a target mounted in the shield).
- b. Be capable of maintaining grade to within plus or minus one inch and line to within plus or minus 1.5 inches.
- c. Provide active steering information which shall be monitored and transmitted to the operation console.
- d. Provide minimum steering information available to the operator on the control console which includes the position relative to the reference, role, inclination, attitude, rate of advance, installed length, thrust force, and cutter head torque.

## **6. Ventilation and Monitoring**

Equipment shall be provided to adequately ventilate the entire micro-tunneling operation at all times during construction.

- a. Portable testing equipment shall be provided for carbon monoxide gas, hydrogen sulfide gas, oxygen deficiency and explosive gases.
- b. An automatic gas alarm to detect explosive gases shall be provided on the Micro-Tunnel Boring Machine. The audible alarm shall be located in the jacking pit and shall be active at all times.

## **7. Electrical Systems**

All electrical systems utilized on the Micro-Tunnel Boring Machine shall be equipped with appropriate ground fault systems. All electrical systems are to be insulated, not permitting any bare wire exposures. Motors and controls shall be equipped with an automatic shutoff such as MSA Methane Monitoring System VI or equal.

## **8. Additional Safety Equipment**

Necessary equipment for tunnel excavation shall include signal systems, fire extinguishers, safety equipment, and other equipment required by the General Contractor's method of construction. Such equipment shall be maintained in good repair.

#### **7.2.11.2 Jacked Pipe**

Pipe for jacking shall be designed to carry all jacking loads. Refer to individual pipe specification sections.

#### **7.2.11.3 Pipe Joints**

The outside walls shall be straight without bell modifications. All joints shall be watertight.

#### **7.2.12 Design**

The General Contractor shall be responsible for the design of the fiberglass reinforced polymer mortar pipe to carry the loads imposed on it during construction, including the jacking forces.

#### **7.2.13 Excavation**

##### **7.2.13.1 General Tunnel Requirements**

Tunnel excavation shall not begin until:

- a. The work Plan and all required submittals have been submitted by the General Contractor and reviewed and returned approved by the Construction Project Manager.
- b. The required Pre-Construction Surveys have been completed.
- c. All instrumentation along the tunnel alignment is in place, stable, and baselines have been established.
- d. All pre-job safety meetings required by OSHA and/or General Contractor's Safety Plan have been held.

#### **7.2.14 Micro-Tunneling**

The General Contractor shall conduct all micro-tunneling operations in accordance with all applicable safety rules and regulations. The following shall apply to micro tunneling operations:

1. No work shall commence until the design and construction procedure has been approved in writing by the Construction Project Manager. The General Contractor is totally responsible for the performance of the equipment and methods selected for this phase. The Construction Project Manager's approval signifies only that the construction process is compatible with the overall objectives of the project.
2. The pipe used for jacking shall be round, have a smooth, even outer surface, and have joints that allow for easy connections between pipes. Pipe ends shall be square and smooth so that jacking loads are evenly distributed around the entire pipe joint and such that point loads will not occur when the pipe is jacked in a reasonably straight alignment. Pipe used for jacking shall be capable of withstanding all forces that will be imposed by the process of installation, as well as the final in place loading conditions. The driving ends of the pipe and intermediate joints shall be protected against damage.

3. The pipe, insofar as practical, shall be micro-tunneled from the downstream end.
4. A jacking frame shall be provided for developing a uniform distribution of jacking forces around the periphery of the pipe. Special care shall be taken by the General Contractor to ensure that the thrust reaction backstop is properly designed and constructed. The backstop shall be square with the proposed pipe alignment and shall be designed to support the maximum obtainable jacking pressure with a factor of safety of at least 2.0. The jacking system shall be capable of continuously monitoring the jacking pressure and rate of advancement. Special care should be taken when setting the pipe guard rails in the pit to ensure correctness of the alignment.
5. The General Contractor shall maintain an envelope of bentonite slurry, or other similar material, around the exterior of the pipe during the jacking and excavation operation to reduce the exterior friction and the possibility of the pipe freezing in place. Water jetting of the pipe bedding or backfill shall not be permitted.
6. The pipe freezes and the General Contractor is unable to move it again, the General Contractor may be permitted to construct an intermediate access pit, with the location subject to review by the Construction Project Manager . The General Contractor shall be solely responsible for making arrangements for such an intermediate pit and shall be solely responsible for any and all costs associated with the location and construction of the pit and for maintaining traffic in the area.
7. In the event a section of pipe is damaged during the jacking and excavation operation, one of the following procedures shall be used to correct the damage, as directed by the Construction Project Manager.
  - a. Slightly damaged pipe which passes leakage test and maintains pipe barrel and joint structural integrity shall be repaired in place with a method approved by the manufacturers.
  - b. Severely damaged pipe shall be removed from the excavation by jacking it through the excavation and removing it at an access pit.
8. The joints shall be made watertight by using rubber gaskets.
9. The pipe joints shall be cushioned by a plywood ring between the joints, or by other methods, to transmit the jacking forces without damage to the pipe or pipe joints.
10. After the pipe is in place and the jacking and excavation operation is complete from one access pit to the next; any over excavation greater than the pipe outside diameter plus 3/4 inch shall require the pipe to be grouted in place.

### **7.2.15 Grouting**

The General Contractor shall furnish and operate suitable equipment for all grouting operations.

After completion of the jacking operation, the lubricate material shall be displaced from between the pipe exterior and surrounding ground by a cement grout. Pressure and the amount of grout shall be controlled by the General Contractor to avoid pipe damage and

displacement of the pipe and soil beyond specified tolerances. Grouting shall be accomplished as soon as possible after pipe installation has been completed to prevent any surface settlement due to movement of soil material into the void space or loosened zone around the pipe.

All voids outside the limits of the excavation created by caving or collapse of earth cover over the excavation, or by other cause shall also be completely filled with pea sized gravel or sand cement grout. Pressure-injected grout shall be placed at the same frequency as required when placing grout behind the pipe.

Pressure-injected grout used in conjunction with pea gravel shall be placed behind the pipe if required to minimize ground loss. General Contractor shall provide seals on the tail of the tunnel boring machine which will prevent the pea gravel or grout from moving into the shield.

### **7.2.16 Jacking Pits**

Construction techniques required to provide access for micro-tunneling shall be such as to ensure the safety of the work. Acceptable excavation methods include the use of interlocked steel sheetpiling or open excavation. Final dimensions of access pits selected by the General Contractor shall conform as a minimum with dimensions required to permit installation of the work.

The General Contractor shall be required to properly support all excavations and to prevent all movement of the soil, pavement, utilities or structures outside of the excavation. All pits shall conform to applicable Local Safety Standards, OSHA Standards, trenching, and shoring standards.

If at any time the method being used by the General Contractor for supporting any material or structure adjacent to any excavation is not safe in the opinion of the Construction Project Manager or applicable federal, state or local inspection authorities, the Construction Project Manager may require and the General Contractor shall provide additional bracing and support necessary to furnish the added degree of safety required by the Construction Project Manager. The General Contractor shall provide such added bracing and support by such method approved by the Construction Project Manager as he may elect to use but the taking of such added precautions shall in no way relieve the General Contractor of his sole final responsibility for the safety of lives, work, and structures. The use of such additional bracing and support shall be without additional cost to the City. The absence of an order from the Construction Project Manager for the aforementioned additional bracing shall in no way relieve the General Contractor of his sole final responsibility.

Pits shall be constructed to accommodate the installation of pipe casings, slurry shield, and jacking device. Install thrust block as required and consolidate the ground where the casings enter and exit the ground.

All work of excavating shoring and bracing shall be so executed that settlement is minimized, the in-place casing shall have full bearing against earth, and no voids or pockets are left in any portion of the work.

Before beginning construction, the General Contractor shall adequately protect existing structures and other permanent objects. The repair of or compensation for damage to permanent facilities due to negligence or lack of adequate protection on the part of the General Contractor will be at no cost to the City.

The General Contractor shall provide surface drainage during the period of construction to protect the work. Provide all dewatering and test any groundwater discharges. All discharge limits and reporting requirements shall be the responsibility of the General Contractor.

Size and locate pits and their work areas so as to avoid interference with traffic.

Blasting will not be permitted.

#### **7.2.17 Line and Grade**

The Construction Project Manager has established the baselines and benchmarks as indicated on the Contract Drawings. The General Contractor shall check these baselines and benchmarks at the beginning of the contract period and report any errors or discrepancies to the Construction Project Manager.

The General Contractor shall use the baselines and benchmarks to furnish and maintain all reference lines and grades for the micro-tunnel construction. These lines and grades shall be used to establish the exact location of all micro-tunneling, excavations and structures.

The General Contractor shall establish and be fully responsible for the accuracy of his own control for the construction of the entire project, including access shaft locations, structures, excavation, pipe alignment and grade. The General Contractor shall submit copies of field notes used to establish all lines and grades.

The General Contractor's control points shall be established sufficiently far from the tunnel operation not to be affected by ground movement.

The General Contractor shall maintain daily surveying records of alignment and grade and shall submit three copies of these records to the Construction Project Manager . The General Contractor, however, remains fully responsible for the accuracy of his work and the correction of it, as required.

The General Contractor shall check his control for his excavation against an above ground undisturbed reference at least once each week and once for each 250 feet of tunnel constructed, or more often as needed or directed by the Construction Project Manager .



After installation of the sewer pipe, the General Contractor shall provide the Construction Project Manager with access to the tunnel for visual inspection of the line and grade of the completed in place sewer pipe.

Guidance laser system shall be mounted in a manner that isolates it from effects of movement by the jacking forces.

#### **7.2.17 Earth Movement**

The General Contractor shall be responsible for all damages due to settlement from any construction induced activities or occurrences.

The General Contractor is advised of the proximity of buildings, structures, roads, and utilities to the work. Precautions shall be taken to avoid damage or settlement to any of these. Such precautions shall include the use of construction methods and equipment to minimize loss of earth at the excavation face and settlement of earth around the sewer pipe.

In the event any movement of earth is detected, the Construction Project Manager may order the work stopped and secured. Before proceeding, the General Contractor shall correct any problems causing or resulting from such movement.

The General Contractor should be aware that if settlement of the ground surface should occur during construction, which will affect the accuracy of the temporary benchmarks established by the Construction Project Manager, it shall be the General Contractor's responsibility to detect and report such movement. The locations of the permanent City monumentation benchmarks (BM) and temporary benchmarks (TBM) are indicated on the Drawings; the General Contractor may use these to verify temporary benchmark accuracy. Advise the Construction Project Manager and the City of any settlement affecting the permanent monumentation benchmarks. Upon completion, the field books pertaining to monitoring of the permanent monumentation benchmarks shall be submitted to the City.

#### **7.2.18 Excavated Material**

Remove and dispose of all excavated materials from jacking pit and tunnel excavations in accordance with the requirements of State of Colorado.

#### **7.2.19 Infiltration Leakage Test**

The tests shall be performed by the General Contractor under the observation of the Construction Project Manager. A test section is defined as the length of tunnel between manholes or structures.

Leak testing shall be by television inspection after dewatering operations have been discontinued a minimum of 48 hours and until groundwater has been allowed sufficient time to reach its natural elevation. Any leakage found during this operation shall be corrected.

Each joint shall also be tested in place by exerting a pressure of 11.2 psi absolute on it in accordance with ASTM D 3754. The internal test pressure, which is 3.5 psi lower than normal atmospheric pressure, shall be in addition to the normal external hydrostatic pressure exerted on the pipe by the groundwater above the pipe. Each joint when tested in this manner shall exhibit no infiltration of groundwater into the pipe. The General Contractor may at his option, test sections of the sewer using this method instead of individual joints. If this method is selected each section shall exhibit no infiltration of ground water into the section. The General Contractor shall isolate any joints which are found to leak during this test and jack such joints through until all joints between manholes are found to be watertight under these conditions.

One hundred percent of the sewer and sewer joints shall be tested.

The General Contractor shall repair all visible leaks in manholes, structures, and joints even if the leakage test requirements are met.

Adequate bulkheads, or plugs, shall be installed at each end of the sewer pipe in preparation for testing. The General Contractor shall submit the type of bulkhead, or plug, to be used to the Construction Project Manager for review. After testing, the bulkheads or plugs shall remain in place until the sewer is put into service, at which time the General Contractor shall remove the bulkheads or plugs.

#### **7.2.20 Restoration**

The General Contractor shall promptly restore to their original condition any streets, curbs, sidewalks, or any other facilities which are damaged, moved or disturbed as a result of tunneling operations or jacking pit construction. Any surface or subsurface settlement shall be restored to pre-construction conditions.

**End of Specification**



CITY AND COUNTY OF DENVER  
ENGINEERING DIVISION

# Wastewater Capital Projects Management Standard Construction Specification

---

## 7.3 SHAFT EXCAVATION AND SUPPORT

### 7.3.1 Definitions

#### 7.3.1.1 Geotechnical Data Report (GDR)

A document that presents an interpretation of the known subsurface data for the project.

The purpose of the GDR is to compile all geological, geotechnical, groundwater, and other data obtained from the geotechnical investigations for use by the various participants in the project. If available, this information will be included within the contract documents as specifically applicable to the project.

#### 7.3.1.2 Geotechnical Baseline Report (GBR)

The intent of a GBR is to clearly and contractually define the geotechnical conditions through which tunneling will occur in order to evaluate a differing site condition (if encountered) and it is used as a basis of bid for the contractor. By assessing the anticipated geotechnical conditions for a project and providing baselines in the contract, the contractor has a basis from which to prepare their bid and select their means and methods. The baseline conditions do not necessarily reflect the actual conditions; they are not geotechnical fact to be encountered. Rather, they represent the owner's assumption of existing geotechnical conditions for the project. If available, this information will be included within the contract documents as specifically applicable to the project. Regardless of inclusion, this information shall be investigated, interpreted, verified and/or developed by the contractor prior to commencement of the work.

### 7.3.2 Section Includes

The work specified in this section includes requirements for design, excavation, and support of the entry shaft(s), jacking pit(s), exit shaft(s), and receiving pit(s) for all tunneling operations required within the Contract Documents. The Contractor shall design, furnish, install, and maintain a system of supports, including all bracing and associated items, to retain excavations in a safe manner and to control ground movements as specified herein. Acceptable means of shaft support include: pre-fabricated systems such as slide-rail; rib and lagging; sheet pile; or liner plate. The means and methods utilized to accomplish the project scope are the Contractor's responsibility. All costs incurred for completion of this item shall be included within the applicable bid item(s) for construction of the associated facility.

### 7.3.3 Requirements

The Contractor shall have the sole responsibility for maintenance and protection of existing utilities, structures, railroad tracks, and facilities within the zone impacted by shaft construction.

The Contractor shall have the sole responsibility for sizing the shafts within the site boundaries shown on the Construction Drawings. The size of the excavations shall be adequate to construct all structures required and to gain access to tunneling and contact grouting operations.

Shaft support systems shall be in accordance with OSHA Health and Safety Standards for Excavations, 29 CFR Part 1926. Shaft support systems shall also meet the standards and guidelines of all **applicable utility companies, and stakeholders**.

The Contractor shall allow the Engineer, City's Construction Project Manager and City's Project Management Team access to the shafts, and to use the shafts to access tunnel operations.

### 7.3.4 Submittals

#### 7.3.4.1 Preconstruction

Submit the following shop drawings and plans a minimum of 8 weeks prior to beginning shaft construction to allow for review by the City's Construction Project Manager, utility owners, and stakeholders:

1. Detailed description of the procedures, equipment, and methods proposed to conduct the shaft excavations.
2. Shop drawings of shafts including locations, dimensions, and support elements.
3. Shop drawings and descriptions of the procedures and methods proposed for the construction shoring system(s), including a minimum: erection scheme; support element descriptions, sizes, spacings, and strengths; design calculations; plan for removal of shoring. Shafts shall be designed and constructed to withstand all imposed loads, including soil conditions, **Cooper E80 loads**, dynamic loads from
4. Equipment and surcharge loads from materials. Calculations shall include loads, methods, assumptions, results, and safety factors. Shop drawings and calculations shall be signed and stamped by a professional engineer registered in the State of Colorado.

### 7.3.5 Materials

#### 7.3.5.1 Structural Steel

Structural steel members, such as fabricated connections and accessories, steel W shapes, and other structural steel shall conform to the requirements of ASTM A 572 or ASTM A 36, unless otherwise approved.

### **7.3.5.2 Slide-Rail**

Pre-engineered system of panels, corner slide-rails, linear slide-rails, and cross braces as manufactured by Speed Shore Corporation or equivalent.

### **7.3.5.3 Lagging**

Timber lagging shall be of construction grade and shall be any species that provides a minimum allowable bending stress of 1,100 psi.

### **7.3.5.4 Lagging Backfill**

Backfill sand shall conform to ASTM C 778 for 20-40 sand. Plugging material such as Excelsior or dry pack shall be used to prevent backfill sand from running.

### **7.3.5.5 Sheet Piles**

Steel sheet piling shall be continuous interlocking made in accordance with ASTM A 328 or ASTM A 857 or from steel meeting the requirements of ASTM A 570 or ASTM A 36.

### **7.3.5.6 Liner Plate**

Steel for liner plate shall be ASTM A 569 with a minimum yield of 28 ksi and a minimum ultimate strength of 42 ksi.

### **7.3.6 General Shaft Requirements**

Commence shaft excavations only after submittals have been reviewed and approved by the Engineer, applicable utility companies, and stakeholders, and a pre-construction meeting has been conducted.

Provide all excavations with a gravel pad or concrete working slab equipped with a sump to pump out water.

No gasoline-powered equipment shall be permitted. Diesel, electrical, hydraulic, and air powered equipment is acceptable, subject to applicable City, State, and Federal regulations.

### **7.3.7 Utilities**

All utilities shall be preserved without interruption.

Location of utilities shown on the Construction Drawings shall be considered approximate. Field locate each utility potentially impacted by the work to verify location prior to beginning underground construction at each location.

Coordinate with each utility agency as necessary prior to relocation, hanging, or upgrade of utilities in the vicinity of shafts, pits, and excavations.

### **7.3.8 Slide-Rail**

The slide-rail system shall be installed simultaneous with soil excavation in accordance with manufacturer recommendations.

### **7.3.9 Soldier Pile and Lagging**

Install piles in predrilled holes to the tip elevations shown on approved submittals. Provide casing or drilling mud as needed to prevent caving of holes and loss of ground in predrilled holes.

After soldier pile has been seated plumb in the drill hole, encase it with concrete from the tip to the bottom level of the final excavation. Concrete strength shall be in accordance with approved submittals, and shall be placed by means of a tremie system. Apply vibration through the pile.

Provide timber lagging of sufficient strength to withstand lateral earth pressures. Install lagging with no gap between adjacent boards. As installation progresses perform the following as selected by the excavation and support designer: 1) backfill the voids between the excavation face and the lagging with sand or pea gravel packed into place, 2) pack voids with materials such as straw, burlap, or geotextile fabric, or 3) grout voids with cementitious materials. Where necessary, allow drainage of groundwater without loss of ground due to piping.

### **7.3.10 Steel Sheet Piling**

Drive in plumb position with each sheet pile interlocked with adjoining piles for its entire length so as to form a continuous diaphragm throughout the length of each run of wall, bearing tightly against original ground.

Drive to the depth indicated on approved shop drawings; exercise care in driving to avoid damaging adjacent utilities and structures, and so that interlocking members can be extracted without damaging adjacent structures or utilities.

### **7.3.11 Liner Plate**

Install liner plate around the full perimeter of the shaft excavation. The unsupported height of soil at the base of the shaft shall be no greater than the height of one course of liner plate. Upon completion of liner plate installation, backfill the annulus between support elements and the ground with excelsior and/or grout as needed to prevent inflow of soil or groundwater.

### **7.3.12 Internal Bracing System**

The internal bracing support system shall include wales, struts, and/or shores as applicable.

Provide web stiffeners, plates, angles, and struts with intermediate bracing as needed to prevent rotation, crippling, or buckling of connections and points of bearing between structural steel members. Allow for eccentricities caused by field fabrication and assembly.

Install and maintain all bracing support members in tight contact with each other and with the surface being supported.

### **7.3.13 Disposal of Excess Excavated Material**

Excess excavated material shall be disposed of in accordance with the Contract Documents.

#### **7.3.14 Removal of Support System**

Temporary shoring systems shall be removed completely at the end of the job. If the Contractor intends to leave any portion of the support system in the ground permanently, he must first get the approval of the property owner where the support elements are located. In the event that the support system is not fully removed, all shoring elements within 5 feet (minimum) of the ground surface, including soldier piles, wales, struts, lagging, sheet piles, and shores shall be removed. Removal of the support system shall be performed in a manner that will not disturb or harm adjacent construction or facilities and only after backfill has been fully compacted. All voids created by the removal of the construction shoring system(s) shall be immediately filled with controlled density fill, lean concrete, or cement grout, as approved by the City's Construction Project Manager.

**END OF SPECIFICATION**



CITY AND COUNTY OF DENVER  
ENGINEERING DIVISION

## Wastewater Capital Projects Management Standard Construction Specification

---

### 7.4 PERMEATION GROUTING

#### 7.4.1 Definitions

##### 7.4.1.1 Geotechnical Data Report (GDR)

A document that presents an interpretation of the known subsurface data for the project. The purpose of the GDR is to compile all geological, geotechnical, groundwater, and other data obtained from the geotechnical investigations for use by the various participants in the project. If available, this information will be included within the contract documents as specifically applicable to the project.

##### 7.4.1.2 Geotechnical Baseline Report (GBR)

The intent of a GBR is to clearly and contractually define the geotechnical conditions through which tunneling will occur in order to evaluate a differing site condition (if encountered) and it is used as a basis of bid for the contractor. By assessing the anticipated geotechnical conditions for a project and providing baselines in the contract, the contractor has a basis from which to prepare their bid and select their means and methods. The baseline conditions do not necessarily reflect the actual conditions; they are not geotechnical fact to be encountered. Rather, they represent the owner's assumption of existing geotechnical conditions for the project. If available, this information will be included within the contract documents as specifically applicable to the project. Regardless of inclusion, this information shall be investigated, interpreted, verified and/or developed by the contractor prior to commencement of the work.

##### 7.4.1.3 Permeation Grouting

The direct pressure injection of a chemical fluid grout into the ground to fill the spaces between soil particles, without causing excessive movement or fracturing of the soil formation. Permeation grouting is performed prior to commencement of tunneling operations to provide a more consistent and stable soil matrix.

##### 7.4.1.4 Chemical Grout

A chemical fluid grout that sets and alters the physical properties of a geologic mass, typically composed of (1) matrix forming base materials, (2) reactants and, (3) accelerators or retarders.



### **7.4.2 Section Includes**

This item includes pre-excavation ground stabilization as required within the Contract Documents by permeation grouting. Permeation grouting shall be performed in accordance with these specifications. If applicable, the general extents of permeation grouting for a specific project may be shown in the plans.

### **7.4.3 Requirements**

The purpose of the grouting program is to stabilize non-cementitious granular soil and fill as shown on Construction Drawings. The permeation grouting program is to be completed prior to beginning tunnel construction.

The effectiveness of the grouting program shall be verified in accordance with requirements specified herein.

Restricted work hours and permits are as specified in the Contract Documents. The Contractor shall coordinate all work with affected utility companies, and stakeholders and comply with the requirements outlined within any access and/or construction permit obtained by the City.

### **7.4.4 Quality Control**

Before the Contractor begins tunnel construction, demonstrate to the City's Construction Project Manager, using either drilling and sampling methods, geophysical methods, data records during grouting operations, or other acceptable means as stated in the approved quality control program, that the grouting zones have been thoroughly impregnated and stabilized with chemical grout. If grouting zones are found to be inadequately treated, the Contractor shall perform additional chemical grouting as needed and at no additional expense to the City.

The Contractor shall obtain samples of grout used for chemical grouting for gel time checks: at least one for every half-hour of pumping or for every 250 gallons of grout, whichever is more frequent. The gel samples shall be labeled and stored in accordance with manufacturer recommendations until completion of the project.

### **7.4.5 Submittals**

#### **7.4.5.1 Preconstruction**

Submit the following shop drawings and plans a minimum of 8 weeks prior to mobilization of grouting equipment for review by the City's Construction Project Manager, utility owners and stakeholders:

1. Certificates of compliance for materials specified herein. Certificate of origin for reactant materials.
2. Proposed grout mix, gel time, and certified laboratory testing results documenting the required strength of soil samples injected with the proposed chemical grout mix,

at least 45 days prior to beginning grouting operations.

3. Detailed chemical grouting work plans and shop drawings, describing the grouting approach, the chemical grout to be used, grout hole locations and orientations, grout pipe installation procedures, locations and arrangement of injection points, grouting equipment, injection procedures and sequences, proposed injection pressures, recording equipment, data reporting methods, work sequences, schedules, method of monitoring and protecting existing utilities; testing methods to be used to verify the effectiveness of grouting with respect to strength and acceptance criteria; quality assurance program and methods for determining that grouted zones are effectively stabilized; and any other information necessary to demonstrate compliance with the specified purpose of this grouting work. Also show grout target volumes at each proposed grout injection point including assumptions with respect to porosity and target volumes. Indicate cure time required for chemically grouted soil to obtain required strength prior to tunneling.

#### **7.4.5.2 During Construction**

Submit records of grouting operations to the City's Construction Project Manager on a daily basis. Include grout mix, gel time, injection date and time, injection pressure and rate, injection volumes and exact injection locations. Provide data in an acceptable chart-type format that facilitates rapid visual evaluation of the results of the work, and update daily.

Submit results of surface monitoring point and settlement monitoring point array monitoring on a daily basis.

Submit test results by the end of the day in which they were taken, and with frequency as specified herein.

Within one week of completion of the grouting program, submit an as-built sketch showing locations, depths and orientations of drilled holes and any grout pipes left in place.

#### **7.4.6 Materials**

##### **7.4.6.1 Chemical Grout**

Chemical grout shall consist of a liquid sodium silicate base, reactant, water, accelerator, and other admixtures as required. The Contractor shall design the chemical grout mix so that when injected into standard medium dense sand (Ottawa 20-30) specimens, the unconfined compressive strength of the grouted test sample is no more than 200 psi and no less than 100 psi. The Contractor shall design the trial mix and conduct laboratory tests to verify trial mix meets strength requirements in accordance with ASTM D4219 and D4320.

##### **7.4.6.2 Base Material**

The base material for the grout shall be liquid sodium silicate with a specific gravity of 1.4 to 1.5 and a silicate-to-soda ratio of 3.20 to 3.35. The minimum sodium silicate concentration shall be 50 percent of the mix by volume. Sodium silicate shall be delivered in sealed containers, or a certified tank truck, accompanied by the supplier's certificate of origin.

#### **7.4.6.3 Reactant**

The reactant shall be an organic base type which, when properly mixed with other grout components, provides a permanent, irreversible gel with controllable gel times. The resulting gels shall exhibit less than 15 percent syneresis in 30 days when mixed with appropriate amounts of sodium silicate, water and accelerator, and shall not exhibit objectionable odors such as ammonia. Sodium bicarbonate, sodium aluminate and other reactants that produce a temporary grout are not allowed. Reactant shall be delivered in sealed containers, accompanied by the supplier's certificate of origin.

#### **7.4.6.4 Water**

Water shall be potable and free of impurities that will deleteriously affect the grout gelling characteristics and strength development of the grouted soil.

#### **7.4.6.5 Accelerator**

An accelerator may be utilized if required. It shall be technical grade, water soluble calcium chloride or other approved salt, containing a minimum amount of insolubles.

#### **7.4.6.6 Drilling Equipment**

Drilling equipment shall be of the type and capacity suitable for drilling the required hole diameters to the tolerances identified or established by the Contractor through evaluating the potential ground conditions from the Geotechnical Data Report and/or Geotechnical Baseline Report, as applicable. Drilling equipment shall also be able to drill at the approved inclinations and depths for installing grout pipes.

#### **7.4.6.7 Grouting Equipment**

Chemical grouting equipment shall have the capacity and mechanical capability to do the work as described herein. The equipment shall be maintained in good operating condition at all times. If grout holes are lost or damaged due to mechanical failure of the equipment, inadequacy of grout supply, or improper injection procedure, the Contractor shall backfill these holes and replace them at no additional cost to the City.

The chemical grout plant shall be a continuous mixing type capable of supplying, proportioning, mixing and pumping the grout with a gel time as specified. Batch-type systems are not permitted. The main pumps shall be equipped with recording, positive displacement meters that will accurately measure the volumes of the various components pumped. Meters shall also be provided at the injection point and at each material line ahead of mixing. The meters shall act independently of the viscosity of the metered fluid. The accuracy of the meters shall be checked at least twice daily.

The pumping unit shall be equipped with piping and/or hoses of adequate capacity to carry the base grout and reactant solutions separately to the point of mixing. The hoses shall be joined using a 'Y' fitting containing check valves to prevent backflow, followed by a baffling chamber. A sampling valve shall be placed beyond the point of mixing and the baffling chamber. The pumping unit shall allow distribution of proportioned grout, under pressure, to the grouting locations monitored by separate, automatic real-time display, flow rate indicators and gauges.

Chemicals shall be stored in metal tanks, suitably protected from accidental discharge. The Contractor shall maintain storage tank capacity sufficient to supply at least one day's worth of grouting materials so as to not interrupt the work if chemical delivery delays occur.

The Contractor shall provide the required chemical quality control testing apparatus on site including, but not limited to: hydrometers, balance scales, graduates, viscometers and other devices required to conduct chemical material acceptance tests, chemical proportioning tests, and grout quality tests for proper quality control of the work.

#### **7.4.7 Grout Pipes**

Grout pipes shall be installed horizontally, inclined, or vertically to obtain the specified minimum grout coverage. Grout pipes shall be re-groutable sleeve-port type grout pipes, with grout ports at maximum 15-inch centers covered by expandable rubber sleeves. After being placed in a borehole, the sleeve-port grout pipes shall be encased in a continuous brittle mortar sheath. An internal double packer shall be used to inject grout at a specific sleeve-port.

#### **7.4.8 Preparation**

Permeation grouting operations shall not begin until geotechnical instrumentation has been installed as required in Section 7.1 of these Standard Construction Specifications.

Coordinate with all affected utility companies as applicable. Coordinate the sequence of operations taking into consideration: a) means of access to the area; b) permitted areas of operations; c) time restrictions for the performance of the Work; and d) maintenance and adherence to utility traffic requirements.

#### **7.4.9 Installation of Grout Pipes**

The Contractor shall locate, protect, support and maintain, without interruption, all utility facilities, equipment and services. Before beginning grout pipe installation from the surface, the proposed grout hole locations shall be marked by the Contractor and cleared by the "on-call" utility notification system. If existing utilities are within 5 feet of proposed grout pipes, the Contractor shall pothole the utilities before installing grout pipes.

Close coordination with the affected utility companies and/or property owners will be necessary when installing grout pipes, in terms of both grout pipe location and the timing of installation.

The minimum extents of the soil zones to be grouted are shown on the Construction Drawings. The intent of the grouting program is to treat granular soil and fill. During drilling, the Contractor should be able to distinguish these granular soils from cohesive soil and fill by drilling action and return of cuttings. Grout pipes shall be installed to the elevations shown on the Construction Drawings or until drilling action indicates that the grout pipes have fully penetrated through the depth of granular soil and fill, whichever is greater.

#### **7.4.10 Grouting Procedures**

Using double packers or other approved suitable measures, inject chemical grout into the selected zones through ports in the sleeve pipes. The Contractor shall use soils information gained while drilling grout pipes to manage the grout plan accordingly. The grouting pressure for any one pipe shall not be more than 2 psi per foot of overburden. Adjust injection procedures as required to prevent surface heave. Temporary high injection pressures are permitted to crack open sleeve-ports, but these pressures are not allowed for longer than one minute.

The Contractor shall conduct a surface pressure test of sleeve port grout tube from manifold to injection point (equivalent to maximum depth) to ascertain system pressure loss. This measured pressure is used for estimating appropriate grouting pressures for production grouting. Inject grout at rates not greater than 10 gpm.

The Contractor shall survey surface monitoring points and arrays each day after grouting operations are completed. Ground heaving and settlement shall not exceed monitoring criteria as specified in Section 7.1 of these Standard Construction Specifications.

#### **7.4.11 Leakage Monitoring**

The Contractor shall closely monitor the rate of grout take during grout injection, and ascertain the cause of sudden drops in grout injection pressures following initial start-up pressure adjustments. Regularly monitor the ground surface adjacent to the grouting site for leakage. In the event that serious grout leaks are observed, the Contractor shall temporarily terminate injection and plug leaks before resuming pumping. The City's Construction Project Manager shall be informed immediately of such leakage.

If excessive grout take is experienced that is not attributable to leakage, the Contractor shall adjust injection pressure, pumping rates, gel or setting times, or grout composition, subject to the acceptance of the City's Construction Project Manager, to reduce grout use to acceptable levels.

#### **7.4.12 Clean Up and Site Restoration**

Remove all equipment, unused materials, and debris from the site at the end of the job. Spilled materials and ground shall be cleaned-up. After tunneling is completed, grout pipes shall be filled with lean cement and cut off within one foot of the ground surface.

Restoration shall follow construction as the work progresses and shall be completed as soon as possible. Restore and repair any damage resulting from heave or spills caused by the work. Any property or improvements damaged or destroyed, shall be restored to a condition equal to or better than existing prior to construction at no additional cost to the City. Restoration shall be completed immediately if a third party or the City is inconvenienced by the damage, and in no case later than thirty (30) days after the damage is discovered. This provision for restoration shall include all property which was affected by the construction operations.

**END OF SPECIFICATION**



CITY AND COUNTY OF DENVER  
ENGINEERING DIVISION

# Wastewater Capital Projects Management Standard Construction Specification

---

## 7.5 COMPENSATION GROUTING

### 7.5.1 Definitions

#### 7.5.1.1 Geotechnical Data Report (GDR)

A document that presents an interpretation of the known subsurface data for the project. The purpose of the GDR is to compile all geological, geotechnical, groundwater, and other data obtained from the geotechnical investigations for use by the various participants in the project. If available, this information will be included within the contract documents as specifically applicable to the project.

#### 7.5.1.2 Geotechnical Baseline Report (GBR)

The intent of a GBR is to clearly and contractually define the geotechnical conditions through which tunneling will occur in order to evaluate a differing site condition (if encountered) and it is used as a basis of bid for the contractor. By assessing the anticipated geotechnical conditions for a project and providing baselines in the contract, the contractor has a basis from which to prepare their bid and select their means and methods. The baseline conditions do not necessarily reflect the actual conditions; they are not geotechnical fact to be encountered. Rather, they represent the owner's assumption of existing geotechnical conditions for the project. If available, this information will be included within the contract documents as specifically applicable to the project. Regardless of inclusion, this information shall be investigated, interpreted, verified and/or developed by the contractor prior to commencement of the work.

#### 7.5.1.3 Compensation Grouting

Compensation grouting is a grouting technique utilized to control ground settlement during soft ground tunneling. Compensation grouting involves the injection of a low slump mortar-like grout under high pressure to compact and displace the adjacent soils. The grout does not penetrate soil pores but displaces the subsurface soils by forming a homogeneous grout bulb near the grout pipe tip. Typically, compensation grouting is done after completion of tunneling to correct for settlement. Compensation grouting may also be performed concurrently with the progress of the tunnel while adjusted grouting parameters continually with reference to measured movements of the ground and/or surface structures, to keep settlement and deformations within specified limits.

### **7.5.2 Section Includes**

This item includes settlement mitigation by compensation grouting. All costs for compensation grouting shall be included within the cost of the associated pipeline and no separate measurement for payment will be made. Within the compensation grouting plan, the Contractor is responsible for design of controls such that bondage between the tunnel pipeline and the compensation grout does not occur and hinder tunnel progression.

### **7.5.3 Requirements**

This work shall consist of installation, monitoring and testing of compensation grouting. It shall be used to mitigate areas of settlement which exceed the limits specified within the Contract Documents.

The Contractor shall provide all labor, materials and equipment to accomplish this work. In addition, the Contractor shall be responsible for all associated costs to comply with City held permits, obtaining additional permits, working within restricted hours and ensuring that all work is coordinated with affected utility companies and stakeholders.

Prior to beginning grout pipe installation, the Contractor shall perform a subsurface investigation to verify the ground conditions above and within the tunnel footprint.

### **7.5.4 Quality Control**

The Contractor shall obtain compensation grout cylinders daily or when the mix design changes. Cylinders shall be 3-inch by 6-inch. Three cylinders shall be taken and marked with the date and time of day collected. Cylinders shall be broken at 7 and 28 days with the remaining cylinder held. Testing shall be performed at a certified laboratory.

The Contractor shall perform slump tests on grout and take measurements of grout mix quantities to verify the grout mix at least twice every shift.

Results of these tests shall be submitted in accordance with these specifications.

### **7.5.5 Submittals**

#### **7.5.5.1 Preconstruction**

Submit the following a minimum of 8 weeks prior to mobilization of grouting equipment to allow for review by the City's Construction Project Manager, utility companies and stakeholders:

1. Description of plant, equipment, and materials, including manufacturer's product data
2. The proposed grout mix design, including: the proposed proportions or range of proportions of each constituent including cement, water, fly ash, sand, bentonite and additives; anticipated characteristics when mixed including density, slump or viscosity as appropriate; expected working time after mixing, time to initial set, and time to achieve 75 percent of design strength; and anticipated properties when set including compressive strength and shrinkage. Include field test data from previous projects

including the compressive strength and slump achieved.

3. Grouting work plan and shop drawings, describing: the grouting approach; the grout mix design; grout pipe locations, spacing, depth, and orientation; grout pipe installation procedures; grouting equipment including pump and pressure capacity; injection procedures and sequences; proposed injection pressures; recording equipment; data reporting methods; work sequence; schedule; method of monitoring and protecting existing utilities; testing methods to be used to verify the effectiveness of grouting with respect to strength and acceptance criteria; and any other information necessary to demonstrate compliance with the specified purpose of this grouting work.
4. Work plan for grouting operations to be performed within affected property owner or utility company corridors.
5. If applicable: Layout and location plan of deep settlement monitoring points used to detect settlement above the crown of the tunnel. Include a description of the instrument type and method of installation. Also, proposed method to monitor the ground surface for heave during grouting.
6. If applicable: Layout and location of boreholes for subsurface investigation.

#### **7.5.5.2 During Construction**

Record and maintain accurate daily records of all grout pipe installation and grouting quantities, including:

- type of drill rig and drilling method used;
- grout pipe locations and tip elevations;
- grout mix;
- grout quantity injected per stage;
- rate of pumping; and
- beginning and final grouting pressure obtained in each stage

The Contractor shall perform slump tests on grout and take measurements of grout mix quantities to verify the grout mix at least twice every shift. These records shall be submitted on a daily basis within one day of the work being performed. The grout cylinder break results shall be submitted 5 days after test results are available.

Within one week of completion of the grouting program, the contractor will submit an as-built sketch showing locations, depths and orientations of drilled holes.

### **7.5.6 Materials**

#### **7.5.6.1 Cement**

Type I or Type II Portland cement (per ASTM C150) free of contamination.



### **7.5.6.2 Sand**

Per ASTM C-33. The fines content shall be greater than 10 percent and less than 30 percent. Natural fines may be supplemented with flyash or bentonite.

### **7.5.6.3 Flyash**

Class C or Class F per ASTM C-618

### **7.5.6.4 Water**

Water shall be potable and free of impurities that will deleteriously affect the grout characteristics.

### **7.5.6.5 Compensation Grout Mix**

A low mobility, viscous grout with a slump between 1-2 inches. Grout shall be a mixture of cement and water, with the potential addition of sand, which will displace soil under pressure but will not penetrate between soil particles. Bentonite, fly ash, and additives may be included. Slump achieved shall be between 1-2 inches.

## **7.5.7 Equipment**

### **7.5.7.1 Grout Pipe Drilling Equipment**

Furnish drilling equipment as required to install grout pipes at locations, depths, and inclinations indicated on the approved work plan in the soil conditions as described in the Geotechnical Baseline Report or as determined via subsurface investigation by the contractor. Use duplex rotary (self-casing) drills to install all grout pipes, or other system(s) as approved by the City's Construction Project Manager. The system must prevent flow of water from the top of the borehole and prevent ground losses as a result of installation. The use of wash boring techniques is not acceptable.

### **7.5.7.2 Subsurface Investigation Drilling Equipment**

If necessary, the Contractor shall furnish geotechnical drilling equipment as required to advance soil borings along the tunnel alignment to confirm ground conditions prior to compensation grouting.

The geotechnical rig shall be a CME55 or similar, or other equipment approved by the City's Construction Project Manager, such that Standard Penetration N-values and split spoon barrel soil samples can be obtained by the Engineer. The rig shall be equipped with hollow stem augers to facilitate sampling and maintain borehole stability.

### **7.5.7.3 Hydraulic Jacking System**

Provide suitable hydraulic jacking system for withdrawing grout pipes in a controlled manner after completion of compensation grouting.

### **7.5.7.4 Grouting Pipes**

Grout pipes and connections shall be steel casing of adequate strength to maintain the hole and to withstand the required jacking and pumping pressures. The pipes shall be at least 2-inches inside diameter to adequately transmit the specified low slump material without

plugging. All casing shall be flush joint threaded or a single piece tubing to provide a smooth inner wall and unobstructed inside diameter. It shall be the Contractor's responsibility to install casing that does not detrimentally impact the grouting procedure.

#### **7.5.7.5 Grouting Equipment**

Equipment used shall be specifically designed for compensation grouting. Because of the high pressure involved, all equipment, including hoses, couplings, gauges and pipes, shall be able to safely operate at the maximum grouting pressures as included in Contractor submittals. The mixing and grout pump system shall be designed to provide continuous flow of the grout mixture at variable flow rates and pressures without interruption during any single hookup or stage due to inadequate batching or pump feed capacity.

#### **7.5.7.6 Grout Mixers**

The mixer shall be a continuous auger type to ensure complete uniform mixing of the materials used and shall be of sufficient capacity to continuously provide the pumping unit with mixed grout at its normal pumping range. The mixer must be capable of volumetrically proportioning the grout materials. Ready mixed grout is also acceptable with an approved mix design.

#### **7.5.7.7 Grout Pumps**

Provide positive displacement grout pump(s) capable of continuously delivering grout at pressures of at least 700 psi or at pressures sufficient to penetrate through previously grouted zones, whichever is larger. Pumping rate shall be readily controllable down to 0.2 cfm. Each grout pump shall be capable of displaying both pressure and injection volume.

#### **7.5.7.8 Grout Delivery System**

The grout delivery system shall consist of hoses, couplings, and pipes compatible with the equipment used for this work and shall be capable of withstanding the pressures delivered by the pump. Pressure gauges shall be provided at the pump discharge and at the top of the injection pipe to monitor pressure.

#### **7.5.8 Utility and Stakeholder Coordination**

Coordinate with all affected utility companies, stakeholders and property owners within the project limits, as applicable. The Contractor shall locate, protect, support and maintain, without interruption, all utility facilities, equipment and services. Coordinate the sequence of operations taking into consideration: a) means of access to the area; b) permitted areas of operations; c) time restrictions for the performance of the Work; and d) maintenance of traffic requirements.

#### **7.5.9 Installation of Grout Pipes**

Before beginning grout pipe installation from the surface, the proposed grout hole locations shall be marked by the Contractor and cleared by the utility notification system. If existing utilities are within 3 feet of proposed grout pipes, the Contractor shall expose the utilities by hand excavation before installing grout pipes. Vacuum excavation may be permitted to expose existing utilities, subject to City's Construction Project Manager's approval.

#### **7.5.10 Compensation Grouting Procedures**

The grouting process shall progress in stages within each pipe starting at the bottom of the pipe, progressing upward at 2-foot intervals. The ground surface and adjacent structures will be monitored by the Contractor during grouting, in accordance with the approved work plan. Heave shall not exceed 1/8 inch. Grout injection shall cease at any given stage when surface heave is detected, when the maximum grouting pressure is reached, or when a sudden drop in pressure is noted.

#### **7.5.11 Clean Up and Site Restoration**

Remove all equipment, unused materials, and debris from the site at the end of the job. Spilled materials and ground shall be cleaned-up. Grout pipes shall be removed from the ground or filled with lean cement and cut off within one foot of the ground surface in accordance with the requirements of the City, utility owner or stakeholder. Restoration shall follow construction as the work progresses and shall be completed as soon as possible. Restore and repair any damage resulting from heave or spills caused by the work. Any property or improvements damaged or destroyed, shall be restored to a condition equal to or better than existing prior to construction at no additional cost to the City. Restoration shall be completed immediately if a third party or the City is inconvenienced by the damage, and in no case later than thirty (30) days after the damage is discovered. This provision for restoration shall include all property which was affected by the construction operations.

**END OF SPECIFICATION**



CITY AND COUNTY OF DENVER  
ENGINEERING DIVISION

## Wastewater Capital Projects Management Standard Construction Specification

---

### **8.0 Structural Excavation**

#### **8.0.1 General**

All excavation for the construction of structures shall be in conformance with the applicable provisions of CDOT Section 206 except as modified herein.

Unless otherwise stipulated in the Contract Documents, no separate payment will be made for structural excavation, except for overexcavation as directed by the Construction Project Manager, and all costs incurred will be considered to be included in the unit price bid for the associated structure or appurtenance. The cost of overexcavation will be paid for as specified below.

#### **8.0.2 Over Excavation**

In locations where soil with unsuitable bearing characteristics are encountered, the Construction Project Manager may order that the unsuitable material be removed and be replaced with granular and/or rock backfill material to provide suitable bearing for the structure.

The overexcavation will be paid for in accordance with the unit price set forth in the Contract Documents for excavation and replacement with an approved granular material; provided, however, no measurement for payment will be made of any material required to fill overexcavated areas: outside of specified pay limits (if applicable), that were for the Contractor's convenience, beyond the limits required for structural excavation, or where excavations for footings, slabs, etc., are made below the required elevations without specific authorization from the Construction Project Manager. Under these circumstances, the excess excavation and backfill required for over excavated area(s) shall be filled in a manner satisfactory to the Construction Project Manager by the Contractor at their expense.

#### **8.0.3 Removal of Water**

All water encountered in excavations shall be removed as required within these Specifications.

#### **8.0.4 Backfill**

Backfill around structures shall be per the requirements set forth within these Standard Construction Specifications.

#### **8.0.5 Site Grading**

The entire site shall be graded using suitable materials from the excavation. Grading shall be for the purpose of providing a neat and pleasing appearance and for facilitating positive drainage. Compaction of all grading material shall be as specified within these Specifications.

**End of Specification**



CITY AND COUNTY OF DENVER  
ENGINEERING DIVISION

## Wastewater Capital Projects Management Standard Construction Specification

---

### 9.0 Pipe Testing, Inspection and Acceptance

#### 9.1 General

In addition to any other testing or inspection requirements set forth elsewhere in these Specifications, all testing, inspection and acceptance of the completed work will be as specified herein.

Test for water-tightness of sanitary sewers shall be conducted by the Contractor at his own expense, except as noted, with the assistance and under the direction of the Construction Project Manager prior to final acceptance.

Unless otherwise specified, storm sewer systems normally will not be required to be tested for leakage. All leakage tests shall be completed and approved prior to placing of permanent resurfacing. Where the difference in elevation between the inverts of adjacent structures (manholes) exceeds 20 feet, no exfiltration leakage tests will be required.

#### 9.2 Testing and Inspection

##### 9.2.1 Exfiltration Test

Unless otherwise noted on the plans, each section of sewer will be tested between successive manholes by closing the lower end of a sewer reach by plugging the pipe at the inlet to the lower manhole and then by filling the sewer and the upper manhole(s) to the proper level with water. The water level in the upper manhole shall be a minimum of 4 feet above the level of the ground water. The maximum exfiltration rate for any section of sewer line shall not exceed the limits specified below:

Pipe Material	Maximum Rate of Exfiltration
Clay, Concrete	200 gal per day/inch diam/mile
PVC, RPMP	50 gal per day/inch diam/mile

For the purposes of exfiltration leakage, manholes shall be considered to be concrete pipe of the same diameter as the manhole i.e. 48, 60 or 72 inch diameter. Air pocket entrapment shall be avoided when filling the line with water. Once filled with water, the system shall be allowed to stabilize for a period of one or two hours before starting the test. Exfiltration leakage rate is determined by measuring the amount of water required to maintain a constant level in the upper manhole. Test duration is to be no less than two hours.

If the leakage, as shown by the test, exceeds the allowable value, the Contractor shall make the necessary corrections at his expense to reduce the exfiltration to within the permissible limits. The Contractor shall furnish all water, material and labor required to perform the test. All tests shall be made in the presence of the Construction Project Manager.

**9.2.2 Infiltration Test**

If the Construction Project Manager determines that excessive ground water is encountered during construction of a sanitary sewer section, the infiltration test for leakage shall be used. The maximum allowable infiltration for sanitary sewers shall not exceed the following limits for the type of projects specified:

Type of Pipe	Max. Allowable Infiltration
Clay, Concrete	200 gal per day/inch diam/mile (3.8 d/inch/100 ft)
PVC, RPMP	50 gal per day/inch diam/mile (0.95 gpd/inch/100 ft)

Unless otherwise specified, infiltration will be measured by the Construction Project Manager, using measuring devices furnished by the City.

If the infiltration is found to exceed the prescribed amount, the Contractor shall make the appropriate repairs as approved by the City and shall continue to test the sewer until it meets requirements.

**9.2.3 Air Pressure Test**

When directed by the Construction Project Manager and prior to acceptance of any segment of newly constructed sanitary sewers, the pipe will be subjected to an air pressure test, which will be conducted after densification of the backfill and prior to installation of any sanitary taps. The test shall conform to the recommended practice and calculations established by the ASTM C-828. After a manhole to manhole reach of pipe has been backfilled, the line should be flushed and cleaned with the interior walls moist. Plugs shall be placed in the line at each manhole and low pressure shall be introduced into this sealed line until the internal pressure reaches 4 psig (pounds per square inch gage) greater than the average back pressure of any ground water that may be surrounding the pipe. At least two minutes shall be allowed for the air pressure to stabilize. The test shall then be run with the drop in pressure from 3.5 to 2.5 psig. The calculations generated by ASTM C-828 shall then be used to check the adequacy of the pipe installation. If the installation fails to meet the requirements, the Contractor shall at his own expense determine the source of leakage

and then shall repair or replace all defective materials and/or workmanship at his own expense to the satisfaction of the Construction Project Manager.

Safety precautions shall be used at all times. It is extremely important that the plugs be installed and braced to prevent blowouts. No one shall be allowed into the manholes during testing.

#### **9.2.4 Television Inspection**

Prior to acceptance of any segment of newly-constructed sewers, all pipes will be televised and physically inspected by the City for any observable defects. This requirement will apply to sanitary sewers and to small storm sewers which are too small to be physically inspected will also be televised. Any defects discovered during this inspection shall be corrected prior to acceptance of the sewer.

The Contractor shall request these televised inspections through the City Construction Project Manager with at least 48 hours advance notification. The cost of initial inspection and the first re-inspection to confirm correction of previously identified deficiencies will be borne by the City. If additional inspections are required due to inadequate or otherwise unacceptable repairs, the costs for such inspections shall be charged to the Contractor.

#### **9.2.5 Deflection Test (Flexible Pipe)**

The City shall conduct deflection tests of all flexible pipes after completion of the work and again 30 days prior to the end of the guarantee period. The Contractor shall, at his expense, furnish a multiarmed test mandrel having an odd number of arms, nine or more in number. The mandrel will be pulled through the lines to be tested by City personnel using the ASTM testing procedure. The Contractor may witness the tests and may receive a copy of the test logs and reports if desired. All test equipment, calibration data, procedures, etc. shall be subject to approval by the Construction Project Manager.

The maximum allowable deflection after installation and backfilling shall not exceed that specified elsewhere in these Specifications for the particular pipe installed. Any segments of the pipe deemed necessary to be unsatisfactory shall be replaced or reworked by the Contractor in accordance with the requirements of the Construction Project Manager. Such repair shall be at the Contractor's expense.

#### **9.2.6 Hydrostatic Test**

Cast Iron, Ductile Iron, PVC Pressure Mains and Force Mains

##### **9.2.6.1 Hydrostatic Tests**

Hydrostatic tests consisting of a Pressure Test and a Leakage Test shall be performed prior to final backfilling. Thrust blocks, anchors, and partial backfill sufficient to anchor the pipeline in place but leaving joints, valves and fittings exposed for inspection shall be performed before testing.

##### **9.2.6.2 Pressure Test**

After the pipe has been laid and partially backfilled, all newly laid pipe, or any valved section thereof, shall be subjected to a pressure test. The test pressure shall be determined by the Engineer. For PVC Pressure mains and Force Mains the test pressure shall be defined in



general accordance with the requirements of AWWA-900 or UNI Bell B-3-77. The duration of the pressure test shall be at least one hour with no discernable loss of pressure.

- a. **Procedure.** Each valved section of pipe shall slowly be filled with water to the specified test pressure, based on the elevation of the lowest point of the line or section under test and corrected to the elevation on the test gage. Air shall be applied by means of a pump connected to the pipe in a satisfactory manner satisfactory to the Engineer. The pump, pipe connections, gages and all necessary test equipment shall be furnished by the Contractor who will make all taps into the pipe. The Contractor shall furnish all necessary assistance for conducting the tests.
- b. **Air Removal.** Before applying the specified air pressure, all air shall be expelled from the pipe. If permanent air vents are not located at all high points, the Contractor shall install corporation cocks at such points so the air can be expelled as the line is filled with water. After the air has been expelled, the corporation cocks shall be closed and the test pressure applied.
- c. **Examination Under Pressure.** All exposed pipe fittings, valves and joints shall be carefully examined prior to placement of backfill. Any cracked or defective pipe, pipe joints, fittings, or valves discovered in consequence of the pressure test shall be removed and replaced by the Contractor, and the test shall be repeated to the satisfaction of the Construction Project Manager.

### 9.2.6.3 Leakage Tests

A leakage test shall be conducted after the pressure test has been satisfactory completed. The Contractor will furnish the gage, measuring device, pump, and pipe connections, other necessary apparatus and the necessary assistance to conduct the test. The duration of each leakage test shall be two hours with an average test pressure determined by the Engineer being maintained during this period.

Leakage shall be defined as the quantity of water that must be supplied into the newly laid pipe, or any valved section thereof, to maintain the specified leakage test pressure after the air in the pipeline has been expelled and the pipe has been filled with water.

No pipe installation will be accepted if the leakage is greater than that determined by the following formula:

$$L = \text{NDVP divided by } 3700$$

For mechanical joints and push-on joints, where L is the allowable leakage in gallons per hour, N is the number of joints in the length of pipeline tested, D is the nominal diameter of the pipe in inches, and P is the average test pressure applied during the test in pounds per square inch gage.

The allowable leakage for 1,000 feet of 18-foot length of mechanical joint or push-on joint pipe at various pressures and diameters is shown in Table 1 of this section.

- a. **Variation from Permissible Leakage.** If any pipe laid discloses leakage greater than that specified above, the Contractor shall, at his own expense, locate and repair the defective joints until the leakage is within the specified allowance.

- b. **Pressure and Leakage Tests after Backfilling.** After the trench has been completely backfilled, the test connections made, and the main filled with water, the pipe shall be subject to a final pressure and leakage test as specified above. If defects are found, the Contractor shall immediately make the repairs and the test repeated until satisfactory to the Engineer.

A final leakage test shall then be conducted after satisfactory completion of the pressure tests. Should any section fail to meet the final leakage test, the Contractor shall make the necessary repairs at his expense.

The duration of the final pressure test and leakage test shall be a minimum of one hour each.

#### **9.2.6.4 Test Report**

The Construction Project Manager shall be furnished a written report of the reports of the Hydrostatic Tests performed; identifying the specific length of the pipe tested, the pressure, the duration of the test and the amount of leakage.

## **9.2 Acceptance**

Portions of the work completed may be placed in operation after all cleaning, and inspection requirements have been fulfilled. Final acceptance of the work will not be made until all requirements set forth in the Contract documents have been completed. Any items of work which the Contractor considers as extra shall be reported to the Construction Project Manager during the progress of the testing and inspection. No consideration of any work items will be made unless substantiating records of the work exist. Any work which the Contractor considers to be extra shall be considered in accordance with General Condition 1101, "Change Order".

**END OF SPECIFICATION**



CITY AND COUNTY OF DENVER  
ENGINEERING DIVISION

## Wastewater Capital Projects Management Standard Construction Specification

---

### 10.1 PRECAST CONCRETE PIPE

#### 10.1.1 General

This section covers material requirements, inspection, marking, delivery, installation, field performance and acceptance of reinforced concrete pipe for storm drainage systems. This shall include circular, elliptical and arch pipe along with all associated special pipe sections.

#### 10.1.2 Referenced Standards

This section references American Society for Testing and Materials (ASTM) Specifications, which are made a part hereof by such references, and shall be the latest edition and revision thereof. All material, manufacturing, operations, testing, inspection and production of concrete pipe shall conform to the following Referenced Standards:

ASTM C14	Concrete Sewer, Storm Drain and Culvert Pipe
ASTM C33	Specification for Concrete Aggregates
ASTM C76	Reinforced Concrete Culvert, Storm Drain and Sewer Pipe
ASTM C150	Standard Specification for Portland Cement
ASTM C361	Reinforced Concrete Low-Head Pressure Pipe
ASTM C443	Standard Specification for Joints for Concrete Pipe and Manholes, Using Rubber Gaskets
ASTM C497	Standard Test Methods for Concrete Pipe, Manhole Sections or Tile
ASTM C506	Reinforced Concrete Arch Culvert, Storm Drain and Sewer Pipe
ASTM C507	Reinforced Concrete Elliptical Culvert, Storm Drain and Sewer Pipe
ASTM C655	Standard Specification for Reinforced Concrete D-Load culvert, Storm Drain and Sewer pipe
ASTM C822	Standard Terminology Relating to Concrete Pipe and Related Products
ASTM C985	Standard Specification for Non-reinforced concrete Specified Strength Culvert, Storm Drain and Sewer pipe

ASTM C1417 Standard Specification for Manufacture of Reinforced Concrete Sewer,  
Storm drain and Culvert pipe for Direct Design

### **10.1.3 Diameter of Pipe**

The diameter indicated on the Contract Documents shall mean the inside diameter of the pipe.

### **10.1.4 Wall Thickness and Class of Pipe**

The wall thickness and reinforcing steel shall comply with the appropriate ASTM Specification and the designated class of pipe as indicated in the Contract Documents. For jacked pipe, the pipe manufacturer shall supply allowable jacking force calculations for each size of pipe supplied for the project. The Contractor is responsible for ensuring that the allowable jacking force is sufficient to install the product based on anticipated site conditions and the forces that the pipe may be subjected to during jacking operations.

### **10.1.5 Submittals**

#### **10.1.5.1 Supplier Certification**

A letter from the supplier to the Construction Project Manager shall be submitted certifying that all Precast Reinforced Concrete Pipe is manufactured in accordance with the applicable ASTM specification.

#### **10.1.5.2 Design Calculations**

All designs shall be per the applicable ASTM designation, except where pipe sizes and or special load conditions are not covered in the specifications. All special designs and load conditions shall require the submittal of design calculations through the Construction Project Manager for approval.

#### **10.1.5.3 Shop Drawings**

Shop drawings showing a laying diagram and the location of all closure pieces shall be submitted. Drawings shall include: proposed lifting anchors, lugs and any other features pertinent to the manufacture of special sections.

#### **10.1.5.4 Gasket Deformation**

Calculations showing the gasket deformation(s) shall be submitted to the Construction Project Manager.

#### **10.1.5.5 Lifting Anchors**

The lifting mechanisms proposed for handling and placement of conduit shall be submitted to the Construction Project Manager for approval.

#### **10.1.5.6 Maximum Allowable Joint Gap**

The manufacturer shall provide the Construction Project Manager with the maximum allowable joint gaps on all conduit sizes for the project. The maximum allowable joint gap is determined as that point where the bevel of the bell and the shoulder of the spigot are vertically aligned and the rubber gasket has achieved the minimum compression necessary to ensure a water tight seal per these Standard Construction Specifications.

### **10.1.6 Materials**

All precast reinforced concrete pipe shall be manufactured in accordance with the applicable ASTM designation or as specified in the Contract Documents.

The Construction Project Manager shall be provided a production schedule at least three working days in advance of when the various types of pipe will be cast so the casting operation may be inspected and appropriate specimens may be selected for testing in accordance with the Contract Documents.

#### **10.1.6.1 Cement**

Unless otherwise specified by the Construction Project Manager, or within the Contract Documents, Type II Portland Cement complying with the requirements of ASTM C150 will be used in the production of concrete pipe.

#### **10.1.6.2 Lifting Anchors**

Lifting anchors shall be used on all precast concrete pipe. Lifting holes are only permitted on jack pipe and will require metal sleeves cast through the pipe wall which are capable of accepting threaded caps that are flush with the pipeline interior after installation. Lift hole sleeves shall be filled with a non-shrink grout prior to installing threaded caps.

#### **10.1.6.3 Fittings and Specials**

Details of all fittings and specials shall be submitted for approval to the Construction Project Manager prior to construction. Fittings and specials shall be made up of pipe segments having the same structural qualities as the adjoining pipe and shall have the interior treated the same as the pipe, except that epoxy coatings shall be allowed.

#### **10.1.6.4 Joints and Gaskets**

Pipe joints for all reinforced concrete pipes shall be formed using rubber gaskets that provide a watertight seal, in accordance with ASTM C443. The joints shall be of such design that they will withstand the forces caused by the compression of the gasket when joined.

- A separate submittal package specific to each pipe size and unique project scenario shall be required for approval by the Construction Project Manager prior to product procurement by the Contractor. At a minimum, this submittal shall include jacking force calculations (see 7.1.4), joint design, and a special pipe detail for each situation.

The joint design of concrete pipe shall be a bell and spigot or a tongue and groove style joint. The spigot or tongue shall be grooved to properly contain and seat the rubber gasket. The joint assemblies shall be accurately formed so that when each pipe section is forced together in the trench the assembled pipe shall form a continuous watertight conduit with a smooth and uniform interior surface, and shall provide for slight movement of any piece of the pipeline due to expansion, contraction, settlement or lateral displacement. The gasket shall be the sole element of the joint providing water tightness. The ends of the pipe shall be perpendicular (90° angle) to the longitudinal centerline of the pipe, except where bevel-end pipe is required. The ends shall be finished so that they are uniform and smooth.

Rubber gaskets for bell and spigot pipe shall consist of an o-ring rubber gasket, rubber profile gasket, or another gasket specifically approved, in writing, by the Construction Project Manager.

Gaskets may be either isoprene or neoprene conforming to ASTM C443. All gaskets shall be stored in a cool place, preferably at a temperature of less than 70 degrees Fahrenheit (F), and in no case shall the gaskets be stored in the open, or exposed to direct sunlight. No gaskets which show signs of deterioration, such as surface cracking or checking, shall be installed in a pipe joint. When the air temperature is 10 degrees F or lower, the gaskets shall be warmed to temperature of 60 degrees Fahrenheit for a period of 30 minutes before being placed on the pipe.

#### **10.1.6.5 Joint Gap**

For reinforced concrete pipe 30-inches (or equivalent diameter for arch and elliptical pipes) and larger, if the end face joint gap is greater than or equal to 65% of the maximum allowable joint gap, as submitted by the manufacturer for each specific pipe size and less any factors of safety, the gap shall be grouted with an approved non-shrink grout product around the entire internal joint perimeter. If the end face joint gap is greater than the maximum allowable joint gap submitted by the manufacturer, at any point around the internal joint perimeter, the adjoining pipe sections will be rejected and no payment will be made.

#### **10.1.6.6 Jacking and/or Microtunneling Pipe**

All other Requirements set forth in this specification shall apply to reinforced concrete pipe being installed via tunneling, in addition to the following:

2. All RCP shall have a flush joint design.
3. The class of pipe shall be as defined in the drawings:
  - Where steel joint rings are specified, they shall conform to ASTM C361, joint type R-2 and shall include steel joint rings on the bell and spigot
  - Where steel bell bands are specified, the pipe shall include a ¼" thick steel bell band which is at least 12" wide or twice the manufactured pipe joint depth, whichever is greater. A separate submittal package specific to each pipe size and unique project scenario shall be required for approval by the Construction Project Manager prior to product procurement by the Contractor. At a minimum, this submittal shall include jacking force calculations, additional reinforcement required to meet the site conditions, and a special pipe detail for each situation.
4. Concrete used in Pipe production shall have a minimum 28-day compressive strength of 6,000 psi, regardless of the class of pipe specified.
5. Grouting nipples shall be spaced no more than 8 feet apart on the installed pipeline.

### **10.1.7 Acceptance**

In addition to any deficiencies not covered by the applicable ASTM specifications, individual concrete pipe sections shall be subject to rejection due to any of the following:

1. Surface defects indicating honeycombed or open texture that would adversely affect the function of pipe sections. Repairs may be made, if approved by the Construction Project Manager.
2. Damaged ends, where such damage would prevent making a satisfactory joint.
3. Pipe which has been excessively patched or repaired. The manufacturer may request that the Construction Project Manager perform an inspection at the plant, prior to delivery, to assess patching and/or repair work on conduits. Pipe damaged during shipment or construction may be repaired with the approval of the Construction Project Manager.
4. Exposure of the reinforcement. The exposure of the ends of longitudinals, stirrups and spacers used to position reinforcement shall not be cause for rejection and may be repaired with the approval of the Construction Project Manager, in writing.
5. Concrete pipe that has been delivered to the jobsite prior to being at least 5 days (120 hours) old, except in cases when evidence that design strengths can be met earlier has been submitted and approved by the Construction Project Manager.
6. Broken bells or spigots on installed pipeline
7. Joint gaps greater than maximum allowable submitted by manufacturer

Acceptance of the pipe at point of delivery will not relieve the Contractor of full responsibility for any defects in materials due to workmanship.

### **10.1.8 Marking**

The following shall be clearly marked on both the interior and exterior surface of the pipe:

1. ASTM specification designation
2. Class and size
3. Date of manufacture
4. Name or trademark of manufacturer

### **10.1.9 Protective Coatings**

Whenever adverse corrosive conditions warrant additional interior protection, those pipe segments noted in the Contract Documents shall be lined as specified elsewhere in these Standard Construction Specifications.

### **10.1.10 Installation**

Reinforced concrete pipe shall be constructed continuously, from downstream to upstream, except when otherwise approved by the Construction Project Manager, in writing. The General Contractor is responsible for matching line and grade as shown within the Contract Documents. Bedding material shall be placed in accordance with these Contract Documents

and all applicable Wastewater Management Division Standard Details to provide uniform and continuous support.

Pipe shall be placed with the groove or bell end upstream. Each conduit section shall be set into position and checked for line and grade prior to continuing placement. The manufacturers' recommendations shall be closely followed during installation.

The General Contractor shall ensure that all reinforced concrete pipe is kept clean and free from gravel, dirt and debris during and after installation. Precautions shall be taken by the General Contractor to eliminate soil and debris from being washed into the sewer prior to completion of the entire system and its appurtenances. The General Contractor shall incur all costs associated with street failures, cave-ins, system washouts and settlements, and conduit cleaning as a result of carelessness during this timeframe.

### **End of Specification**





CITY AND COUNTY OF DENVER  
ENGINEERING DIVISION

## Wastewater Capital Projects Management Standard Construction Specification

---

### 10.3 Precast Reinforced Box Conduits

#### 10.3.1 General

The work of this section includes furnishing and installing all precast reinforced concrete box conduits for storm drainage systems. This shall include all associated special pieces, except inlets and manholes.

#### 10.3.2 Related Sections

Section 4.0, Utility Trenching and Excavation (Wastewater Capital Projects Management Standard Construction Specifications).

#### 10.3.3 Referenced Standards

This section references American Society for Testing and Materials (ASTM) Specifications, which are made a part hereof by such references, and shall be the latest edition and revision thereof. All material, manufacturing, operations, testing, inspection and production of precast reinforced box conduits shall conform to the following standards.

ASTM C150	Standard Specification for Portland cement
ASTM C497	Standard Test Methods for Concrete Pipe, Manhole Sections, or Tile
ASTM C822	Terminology Relating to Concrete Pipe and Products
ASTM C1433	Standard Specification for Precast Reinforced Concrete Box Sections for Culverts, Storm Drains and Sewers
ASTM C443	Standard Specification for Joints for Concrete Pipe and Manholes, Using Rubber Gaskets

#### 10.3.4 Submittals

##### 10.3.4.1 Supplier Certification

A letter from the supplier to the Construction Project Manager shall be submitted certifying that all Precast Reinforced Box Conduits are manufactured in accordance with ASTM C1433.

##### 10.3.4.2 Design Calculations

All designs shall be per the tables of ASTM C1433 except where box sizes and or special load conditions are not covered by these tables. All special designs and load conditions shall

require the submittal of design calculations through the Construction Project Manager for City and County of Denver approval.

#### **10.3.4.3 Shop Drawings**

Shop drawings showing laying diagram and location of all closure pieces shall be submitted. Drawings shall include: proposed lifting anchors, lugs and any other features pertinent to the manufacture of special sections.

#### **10.3.4.4 Gasket Deformation**

Calculations showing the gasket deformation(s) shall be submitted to the Construction Project Manager.

#### **10.3.4.5 Lifting Anchors**

The lifting mechanisms proposed for handling and placement of box conduit shall be submitted to the Construction Project Manager for approval.

#### **10.3.4.6 Maximum Allowable Joint Gap**

The manufacturer shall provide the Construction Project Manager with the maximum allowable joint gaps on all box conduit sizes for the project. The maximum allowable joint gap is determined as that point where the bevel of the bell and the shoulder of the spigot are vertically aligned and the rubber gasket has achieved the minimum compression necessary to ensure a water tight seal per these Standard Construction Specifications.

### **10.3.5 Materials**

#### **10.3.5.1 Box Conduits**

All precast reinforced concrete box conduits shall be manufactured in accordance with ASTM C1433.

The Construction Project Manager shall be provided a schedule at least three working days in advance of when the various types of box conduit will be cast so the casting operation may be inspected and appropriate specimens may be selected for testing in accordance with the Contract Documents.

#### **10.3.5.2 Box Joints**

Box joints for reinforced concrete box conduits shall be formed using either o-ring or profile rubber gaskets that provide a watertight seal. The gasket shall be properly placed on the spigot using an adhesive, as necessary along the joint perimeter, to maintain the correct position of the gasket. Joints for box conduits shall comply with the requirements set forth in ASTM C443, with the following revisions.

- A separate submittal package specific to each pipe size and unique project scenario shall be required for approval by the Construction Project Manager prior to product procurement by the Contractor. At a minimum, this submittal shall include jacking force calculations (see 7.1.4), joint design, and a special pipe detail for each situation.

## 1. Gasket Deformation

The joints shall be of such design that they will withstand the forces caused by the compression of the gasket when the joint is in the assembled and homed position, as well as when the box joint is fully off-centered and the maximum dimensional tolerances are applied.

## 2. Hydrostatic Testing and Requirements

One box joint per size, for each project, shall be hydrostatically tested at the place of manufacture to verify water tightness and joint integrity. Hydrostatic pressure tests on joints shall be made on an assembly of two sections of box, properly connected in accordance with the joint design. Suitable means shall be provided that allows pressure to be applied to the joint, either external or internal of the two joined box sections. When infiltration is a concern, the joint shall be tested using external pressure only.

Assembled joints shall pass the following performance tests without leakage at the joints. Moisture or beads of water appearing on the surface of the joint will not be considered as leakage.

### *Box in straight alignment*

Concrete box conduit shall be subjected to a hydrostatic pressure of 5psi (11.5 ft of pressure head) for 10 minutes in straight alignment. If leakage of joints should initially occur, the manufacturer shall have the option to extend the test period up to 24 hours.

### *Box in maximum deflected position*

Upon completion of the test for box in straight alignment, the test section shall be deflected to create a position ½ inch wider than the assembled position on one side of the outside perimeter of each joint and shall be subjected to a hydrostatic pressure of 3psi (6.9 ft of pressure head) for 10 minutes.

## 3. Joint Gap

If the end face joint gap is greater than or equal to 65% of the maximum allowable joint gap, as submitted by the manufacturer for each specific box size and less any factors of safety, the gap shall be grouted with an approved non-shrink grout product around the entire internal joint perimeter.

### 10.3.5.3 Closure Pieces

All pieces required for closure between precast and cast-in-place elements shall be fabricated with protruding dowels or exposed reinforcing steel, as shown in the Contract Documents, and as approved by the Construction Project Manager. All dowels and/or exposed reinforcing shall be fully developed.

### 10.3.5.4 Special Pieces

Special pieces shall be fabricated as shown on the Contract Documents and shall be approved by the Construction Project Manager prior to fabrication.

#### **10.3.5.5 Lifting Anchors**

Lifting anchors shall be used on all box conduits. Lifting holes will not be allowed.

#### **10.3.6 Acceptance**

In addition to deficiencies covered by applicable ASTM specifications, individual precast reinforced concrete box conduits shall be subject to rejection due to any of the following:

1. Surface defects indicating honeycombed or open texture that would adversely affect the function of box sections. Onsite repairs may be made, if approved by the Construction Project Manager.
2. Damaged ends, where such damage would prevent making a satisfactory joint.
3. Conduit which has been excessively patched or repaired. The manufacturer may request that the Construction Project Manager perform an inspection at the plant, prior to delivery, to assess patching and/or repair work on conduits. Conduit damaged during shipment or construction may be repaired with the approval of the Construction Project Manager.
4. Exposure of the reinforcement. The exposure of the ends of longitudinals, stirrups and spacers used to position reinforcement shall not be cause for rejection.
5. Box conduit that has been delivered to the jobsite prior to being at least 5 days (120 hours) old.

Acceptance of the conduit shall not relieve the General Contractor of full responsibility for defects in material or workmanship on the completed boxlines.

#### **10.3.7 Marking**

The following information shall be legibly marked on each box section by indentation, waterproof paint or other approved means:

1. ASTM specification designation
2. Date of manufacture
3. Name or trademark of manufacturer

#### **10.3.8 Testing**

The Construction Project Manager or other identified representatives shall be permitted to visit the manufacturing facility of the General Contractor's supplier to observe compliance with all applicable testing provisions. These visits may be scheduled or random.

#### **10.3.9 Shipping and Handling Box Conduit and Fittings**

All conduits, fittings, and specials shall be hauled, unloaded, stockpiled, distributed, handled and installed as recommended by the manufacturer and in such a manner as to prevent damage to the product.

#### **10.3.10 Installation**

Box conduit lines shall be constructed continuously, from downstream to upstream, except when otherwise approved by the Construction Project Manager. The General Contractor is responsible for matching line and grade as shown within the Contract Documents. Bedding

material shall be placed in accordance with the Contract Documents and applicable Wastewater Management Division Standard Details to provide uniform and continuous support.

Box conduits shall be placed with the grove end upstream. Each conduit section shall be set into position and checked for line and grade prior to continuing placement. The manufacturers' recommendations shall be closely followed during installation.

The General Contractor shall ensure that all reinforced concrete box conduits are kept clean and free from gravel, dirt and debris during and after installation. Precautions shall be taken by the General Contractor to eliminate soil and debris from being washed into the sewer prior to completion of the entire system and its appurtenances. The General Contractor shall incur all costs associated with street failures, cave-ins, system washouts and settlements, and conduit cleaning as a result of carelessness during this timeframe.

### **End of Specification**



CITY AND COUNTY OF DENVER  
ENGINEERING DIVISION

## Wastewater Capital Projects Management Standard Construction Specification

---

### 10.4 Reinforced Polymer Mortar Pipe

#### 10.4.1 General

This section covers material requirements, inspection and testing, marking and delivery, installation, and field performance and acceptance tests of Reinforced Polymer Mortar Pipe (RPMP), for use in gravity, storm and sanitary sewer installations.

#### 10.4.2 Referenced Standards

This section references American Society for Testing and Materials (ASTM), which are made part hereof by such references, and shall be the latest edition and revision thereof. All material, manufacturing, operations, testing, inspection and production of Reinforced Polymer Mortar Pipe (RPMP) shall conform to the following referenced standards:

- ASTM D3262 Standard Specification for "Fiberglass" (Glass-Fiber-Reinforced Thermosetting-Resin) Sewer Pipe
- ASTM D4161 Standard Specification for "Fiberglass" (Glass-Fiber-Reinforced Thermosetting-Resin) Pipe Joints Using Flexible Elastomeric Seals.
- ASTM D2412 Standard Test Method for Determination of External Loading Characteristics of Plastic Pipe by Parallel-Plate Loading.
- ASTM D3681 Standard Test Method for Chemical Resistance of "Fiberglass" Pipe in a Deflected Condition.
- ASTM D638 Test Method for Tensile Properties of Plastics.

#### 10.4.3 Diameter of Pipe

The diameter indicated on the Contract Documents shall mean the inside diameter of the pipe.

#### 10.4.4 Wall Thickness

The wall thickness and reinforcements shall comply with the appropriate ASTM Specification as indicated in the Contract Documents.

#### 10.4.5 Submittals

##### 10.4.5.1 Supplier Certification

1. A letter from the supplier to the Construction Project Manager shall be submitted certifying that all Reinforced Polymer Mortar Pipe and associated appurtenances are manufactured in accordance with the applicable ASTM specifications.
2. The manufacturer shall provide the Construction Project Manager with the manufacturer's recommended maximum allowable joint gaps and tolerances on all conduit sizes for the project.
3. If the project contains tunneling or boring, please refer to additional submittal requirements elsewhere in this specification.

## **10.4.6 Materials**

### **10.4.6.1 Pipe**

The pipe shall meet the ASTM D3262 standard specification Cell Limit Type 1, Liner 1 or 2, and Grade 1 or 3, with a minimum SN of 46 psi and PN of 25psi, unless otherwise indicated on the plans.

### **10.4.6.2 Joints**

The joints must meet the performance requirements of ASTM D4161. Unless otherwise specified, the pipe shall be field connected with sleeve couplings that utilize elastomeric sealing gaskets made of EPDM rubber compound as the sole means to maintain joint water tightness as otherwise approved by the Construction Project Manager.

The measured pipe joint gap shall not be equal to or larger than 65% of the manufacturer's recommended maximum allowable joint gap.

#### **10.4.6.2.1 Manhole Connection**

Unless otherwise specified the connection at the manhole must be a waster stop gasket or approved equal.

- **A separate submittal package specific to each pipe size and unique project scenario shall be required for approval by the Construction Project Manager prior to product procurement by the Contractor. At a minimum, this submittal shall include jacking force calculations (see 7.1.4), joint design, and a special pipe detail for each situation.**

### **10.4.6.3 Fittings**

Flanges, elbows, reducers, tees, wyes, laterals and other fittings shall be capable of withstanding all operating conditions when installed. They may be contact molded or manufactured from mitered sections of pipe joined by glass-fiber-reinforced overlays. Properly protected standard ductile iron, fusion-bonded epoxy coated steel and stainless steel fittings may also be used.

### **10.4.6.4 Resin Systems**

The manufacturer shall use only polyester resin systems with a proven history of performance in this particular application. The historical data shall have been acquired

from a composite material of similar construction and composition as the proposed product.

#### **10.4.6.5 Glass Reinforcements**

The reinforcing glass fibers used to manufacture the components shall be of highest quality commercial grade E-glass filaments with binder and sizing compatible with impregnating resins.

#### **10.4.6.6 Silica Sand**

Sand shall be minimum 98% silica with a maximum moisture content of 0.2%.

#### **10.4.6.7 Additives**

Resin additives, such as curing agents, pigments, dyes, fillers, thixotropic agents, etc., when used, shall not detrimentally affect the performance of the product.

#### **10.4.6.8 Elastomeric Gaskets**

Gaskets shall be supplied by qualified gasket manufacturers and be suitable for the service intended.

#### **10.4.7 End Squareness**

Pipe ends shall be square to the pipe axis with a maximum tolerance of 1/8".

#### **10.4.8 Packaging, Handling, Shipping**

The Contractor shall follow the procedures and recommendations for packaging, handling, and shipping, in accordance with the manufacturer's instructions.

#### **10.4.9 Jacking and/or Microtunneling Pipe**

All other Requirements set forth in these specifications shall apply to reinforced polymer mortar pipe being installed via tunneling, in addition to the following:

1. All RPMP utilized for Jacking and or Microtunneling shall have a flush joint design.
2. A separate submittal package specific to each pipe size and unique project scenario shall be required for approval by the Construction Project Manager prior to product procurement by the Contractor. At a minimum, this submittal shall include jacking force calculations, joint design, and a special pipe detail for each situation.
3. The pipe manufacturer shall supply allowable jacking force calculations for each size of pipe supplied for the project.
4. The Contractor is responsible for ensuring that the allowable jacking force is sufficient to install the product based on anticipated site conditions and that the forces the pipe may be subjected to during jacking operations do not damage the product.

##### **10.4.4.9 Testing**

1. All pipes shall be manufactured and tested in accordance with ASTM D3262
2. All joints shall meet the requirements of ASTM D4161.
3. Stiffness shall be tested in accordance with the test method of ASTM D2412.



## **10.4.5 Inspection of Product During Manufacturing**

### **10.4.5.1 Customer Inspection**

The owner or other designated representative shall be entitled to inspect pipes or witness the pipe manufacturing.

### **10.4.5.2 Manufacturers Notification to Customer**

Should the Owner request to see specific pipes during any phase of the manufacturing process, the manufacturer must provide the Owner with at least 48-hours advance notice of when and where the production of those pipes will take place.

## **10.4.6 Installation**

### **10.4.6.1 Trenching and Excavation**

Trenching and excavation shall be performed in accordance with Section 4.0 of these Standard Construction Specifications.

### **10.4.6.2 Bedding and Haunching**

The bedding shall be Class B as defined in these Standard Construction Specifications. The bedding material shall conform to ASTM C33 or ASTM D448 gradation No. 67 shall be brought to proper grade and elevation prior to installation of pipe and assembly of joints. Depressions for pipe bell shall be provided. Additional bedding material shall then be placed according to Wastewater Management Division Standard Detail S-301, "Standard Detail for Trenching and Bedding".

### **10.4.6.3 Pipe Handling**

Use textile slings, other suitable materials or a forklift. Use of chains or cables shall not be permitted.

### **10.4.6.4 Jointing**

1. Clean ends of pipe and coupling components.
2. Apply joint lubricant to pipe ends and elastomeric seals of coupling. Use only lubricants approved by the pipe manufacturer.
3. Use suitable equipment and end protection to push or pull the pipes together.
4. Do not exceed forces recommended by the manufacturer for coupling pipe.
5. Join pipes in straight alignment then deflect to required angle. Do not allow the deflection angle to exceed the deflection permitted by the manufacturer.

### **10.4.6.5 Minimum Cover**

Minimum cover depth of compacted fill above the top of the pipe is three (3) feet. If this minimum cover requirement is not attainable, pipes with higher stiffness (SN 72) shall be used for installation.

## **10.4.7 Field Testing**

### **10.4.7.1 Infiltration/Exfiltration Test**

Maximum allowable leakage shall be per local specification requirements.

#### **10.4.7.2 Low Pressure Air Test**

See section 9.2.3

#### **10.4.7.3 Individual Joint Testing**

For pipes large enough to enter, individual joints may be air pressure tested with a single or double bladder tester to 5 psi for 1 minute. If the joint fails then the joint shall be repaired per City approved manufacturer's recommendation.

#### **10.4.7.4 Deflection Testing**

A deflection test shall be performed according to section 9.2.5 of these Standard Construction Specifications. The maximum allowable deflection limits after construction shall be 5% of the initial diameter.

**END OF SPECIFICATION**



CITY AND COUNTY OF DENVER  
ENGINEERING DIVISION

## Wastewater Capital Projects Management Standard Construction Specification

---

### 10.5 Ductile Iron Pipe

#### 10.5.1 General

This section covers material requirements, fittings, field joints and protective coatings for ductile iron pipe.

#### 10.5.2 Referenced Standards

This section references American Society for Testing and Materials (ASTM), American National Standards Institute (ANSI), and American Water Works Association (AWWA), which are made a part hereof by such references, and shall be the latest edition and revision thereof. All material, manufacturing, operations, testing, inspection and production of ductile iron pipe shall conform to the following standards;

ASTM A746	Standard Specification for Ductile Iron Gravity Sewer Pipe
AWWA C110/ANSI A21.10	Standard for Ductile-Iron and Gray Iron Fittings, 3 in. – 48 in
AWWA C111/ANSI A21.11	Standard for Rubber-Gasket Joints for Ductile-Iron Pressure Pipe and Fittings
AWWA C151/ASA A21.51	Standard for Ductile-Iron Pipe, Centrifugally Cast, for Water
AWWA C153/ANSI A21.53	Standard for Ductile-Iron Compact Fittings

#### 10.5.3 Pipe Diameter

The diameter indicated on the drawings shall represent the nominal diameter of the pipe. The inside diameter of the pipe after protective lining has been applied shall not be less than that required for cast iron pipe.

#### 10.5.4 Wall Thickness

The minimum wall thickness and /or pressure class of each section of the pipeline shall conform to that indicated on the Contract Documents, and shall be subject to the approval of the Construction Project Manager.

### **10.5.5 Grade of Iron**

The grade of iron shall be 60-42-10 having a minimum tensile strength of 60,000 psi, minimum yield strength of 42,000 psi, and a minimum percent of elongation of 10 percent.

### **10.5.6 Fittings and Specials**

Fittings and specials shall be ductile iron at least Class 54 thickness and shall be in accordance to the requirements of either AWWA C153/ANSI A21.53 or AWWA C110/ANSI A21.10. Fittings shall be lined as specified in Section 10.5.7a and coated as specified in Section 10.5.7b below.

### **10.5.7 Field Joints**

Mechanical joints shall conform to AWWA C111/ANSI A21.11.

### **10.5.8 Protective Coatings**

Unless otherwise specified. The interior and exterior surfaces shall conform to the following.

1. Interior surfaces shall be lined with calcium aluminates mortar made of fused calcium aluminates cement and fused calcium aluminates aggregates. The thickness of the lining shall be a minimum of 0.125" for 6" through 12" and 0.1875" for 14" through 24" diameter pipe.
2. The lining shall be Sewpercoat® as manufactured by Lafarge Calcium Aluminates or approved equal.
3. Exterior coating shall be a minimum of 1 mil bituminous paint according to AWWA C151/ASA A21.51 - Section 51-8.1.

**End of Specification**



CITY AND COUNTY OF DENVER  
ENGINEERING DIVISION

## Wastewater Capital Projects Management Standard Construction Specification

---

### 10.6 Polyvinyl Chloride (PVC) Sewer Pipe

#### 10.6.1 General

This section covers material requirements, inspection and testing, marking and delivery, installation, and field performance and acceptance tests of Polyvinyl Chloride (PVC) Sewer Pipe and Fittings for use in gravity, non-pressure, storm or sanitary sewer installations.

#### 10.6.2 Referenced Standards

This section references American Society for Testing and Materials (ASTM), American National Standards Institute (ANSI), and American Water Works Association (AWWA), UNI-Bell PVC Pipe Association (UNI), which are made part hereof by such references, and shall be the latest edition and revision thereof. All material, manufacturing, operations, testing, inspection and production of Poly (Vinyl Chloride) (PVC) sewer pipe shall conform to the following referenced standards:

ASTM C33	Standard Specification for Concrete Aggregates
ASTM D448	Standard Classification for Sizes of Aggregate for Road & Bridge Construction.
ASTM F477	Standard Specification for Elastomeric Seals (Gaskets) for Joining Plastic Pipe.
ASTM F679	Standard Specification for Poly (Vinyl Chloride) (PVC) Large-Diameter Plastic Gravity Sewer Pipe and Fittings.
ASTM F789	Standard Specification for Type PS-46 and Type PS-115 Poly (Vinyl Chloride) (PVC) Plastic Gravity Flow Sewer Pipe and Fittings.
ASTM F794	Standard Specification for Poly (Vinyl Chloride) (PVC) Profile Gravity Sewer Pipe and Fittings Based on Controlled Inside Diameter.
ASTM D2321	Standard Practice for Underground Installation of Thermoplastic Pipe for Sewers and Other Gravity-Flow Applications.
ASTM D3034	Standard Specification for Type PSM Poly (Vinyl Chloride) (PVC) Sewer Pipe and Fittings.

### **10.6.3 PVC Sewer Materials**

The following described materials are approved for use in PVC pipe sewer construction.

#### **10.6.3.1 Pipe and Fittings**

Sanitary sewer pipes shall be PVC and conform to: ASTM D3034 SDR 35 for sizes 8 inches to 15 inches in diameter; ASTM F789 for sizes 8 inches to 18 inches (Solid Wall); ASTM F679 for sizes 18 inches to 36 inches (Solid Wall); ASTM F949 for sizes 8 inches to 36 inches (Profile Wall); ASTM F794 for sizes 8 inches to 48 inches (Profile Wall); ASTM F1803 for sizes 18 inches to 60 inches (Profile Wall).

#### **10.6.3.2 Gaskets**

Gaskets shall comply with ASTM F477. It shall consist of a properly vulcanized high grade elastomeric compound. The basic polymer shall be natural rubber, synthetic elastomer, or a blend of both. The gasket shall be the only element depended upon to make the joint flexible and water-tight.

#### **10.6.3.3 Lubricant**

The lubricant used for assembly shall have no detrimental effect on the gasket or on the pipe. Lubricants shall be in accordance with the manufacturer's recommendations.

### **10.6.4 Acceptance**

Acceptance of the pipe, fittings, and other associated sewer material shall be based on full compliance with these Standard Construction Specifications.

#### **10.6.4.1 Certification**

A manufacturer's certification that the material was manufactured and tested in accordance with these Standard Construction Specifications together with a report of all test results shall be furnished at the time of shipment.

### **10.6.5 Receiving, Storage and Handling**

The Contractor shall follow the procedures and recommendation for receiving, storage, and handling contained in the Uni-Bell Plastic Pipe Association, "Handbook of PVC Pipe", and as recommended by the manufacturer.

#### **10.6.5.1 Receiving**

Pipes not conforming to the requirements of these Standard Construction Specifications and pipes damaged in transit shall be rejected by the Construction Project Manager. Acceptance of pipes at the time of delivery does not preclude rejection of the installed sewer pipe which do not conform to these Standard Construction Specifications.

#### **10.6.5.2 Storage**

Pipe shall be stored in unit packages provided by the manufacturer. The unit packages shall be supported by racks to prevent damage to the underside of the pipe. Supports shall be spaced to prevent pipe bending. Stored pipe shall be covered with an opaque material to

prevent exposure to direct sunlight while permitting adequate circulation of the air above and around the pipe to prevent excessive heat accumulation. Pipe determined to have been damaged in storage shall be rejected.

### **10.6.5.3 Handling**

Construction equipment shall be operated in a safe and cautious manner so as to prevent damage to the pipe. Blows to the pipe causing impact damage shall be prevented. Pipe and fittings shall not be thrown, dropped, or dragged.

### **10.6.6 Installation**

Installation of PVC pipe shall be in conformance with ASTM D2321, except where modified by these Standard Construction Specifications.

#### **10.6.6.1 Trenching and Excavation**

Trenching and excavation shall be performed in accordance with Section 4.0 of these Standard Construction Specifications.

#### **10.6.6.2 Bedding and Haunching**

The bedding shall be Class B as defined in Section 4.0 of these Standard Construction Specifications. The bedding material shall conform to ASTM C33 or ASTM D448 gradation No. 67 as modified and shall be brought to proper grade and elevation prior to installation of pipe and assembly of joints. Depressions for pipe bell shall be provided. Additional bedding material shall then be placed according to Wastewater Management Division Standard Detail S-301, "Standard Detail for Trenching and Bedding".

#### **10.6.6.3 Jointing Pipe**

Assembly of all joints shall be in accordance with the recommendations of the manufacturer. Proper jointing may be verified by rotation of the spigot or with a strap wrench. If unusual joining resistance is encountered or if the insertion mark does not reach the flush position, the joint shall be disassembled, inspected for damage, the joint components re-cleaned and the assembly steps repeated.

#### **10.6.6.4 Cutting and Beveling Pipe**

For shorter than standard pipe lengths, field cuts may be made with plastic pipe cutters. Ends shall be cut square and perpendicular to the pipe axis. Spigots shall have burrs removed and ends smoothly beveled by a mechanical beveler or by hand with a rasp or file. Field spigots shall be stop-marked with felt tip marker or wax crayon for the proper length of assembly insertion. The angle and depth of field bevels and length to stop-mark shall be comparable to factory pipe spigots.

#### **10.6.6.5 Sanitary Sewer Connections**

On all new PVC sewer construction, connections shall be made with Wye's or Tee's conforming to ASTM D3034 or F679 whichever is applicable. Only gasketed fittings will be used. Saddle Wye's and Tee's with gaskets for the saddle and joints are approved for sanitary sewer service connection to existing PVC sanitary sewers only. Stainless steel straps shall be used to secure the saddle fittings to the main pipe.

#### **10.6.6.6 Water Stops**

Whenever the PVC sewer pipe joints a manhole and is encased by the concrete manhole base or a cutout in precast manhole base, waterstops or seals shall be used. See City and County of Denver, Wastewater Management Division Standard Detail No. S-550.

- A separate submittal package specific to each pipe size and unique project scenario shall be required for approval by the Construction Project Manager prior to product procurement by the Contractor. At a minimum, this submittal shall include jacking force calculations (see 7.1.4), joint design, and a special pipe detail for each situation.

#### **10.6.6.7 Trench Backfill**

Backfilling of the trench shall as specified in Section 5.0 of these Standard Construction Specifications except that no wheeled vehicles shall be used for compaction or other purpose over the installed pipe until the backfill is at least 30 inches thick measured from the top of the pipe to the backfill surface. Mechanical tampers shall not be used until the backfill is at least 48 inches thick. Direct dumping of material over the top of uncovered pipe will not be allowed.

#### **10.6.7 Field Performance and Acceptance Tests**

##### **10.6.7.1 Television Inspection**

The City will perform a television inspection to verify accuracy of alignment, freedom from debris or obstructions, displacement of gaskets or joints and leaks at joint and service connections. Any of the above discrepancies observed shall be rectified by the Contractor at no cost to the City.

The cost of the initial inspection and the first re-inspection to confirm correction of previously identified deficiencies will be borne by the City. In the event additional inspections are necessary due to inadequate or otherwise unacceptable repairs, the costs for such inspection shall be charged to the Contractor.

##### **10.6.7.2 Air Pressure Test**

An air pressure test using the most recent version of UNI-Bell's UNI-B-6 shall be made. The air pressure test outlined in paragraph 9.2.3 of Section 9.0 of these Standard Construction Specifications will not apply to PVC sewer air testing. The Contractor shall secure adequate copies of UNI-B-6, as published by the Uni-Bell Plastic Pipe Association, and provide at least one copy to the Construction Project Manager.

##### **10.6.7.3 Infiltration Test**

If the ground water level is above the top of the pipe throughout the length being tested, an infiltration test shall be performed. See paragraph 9.2.2 of Section 9.0 of these Standard Construction Specifications.



#### **10.6.7.4 Deflection Test**

A deflection test shall be performed according to paragraph 9.2.5 of Section 9.0 of these Standard Construction Specifications. The allowable deflection limits shall be a maximum of 5% after construction and 6% at the end of the guarantee period. The allowable deflection shall be based on the base inside diameter of the PVC pipe.

#### **10.6.7.5 Reports**

Copies of all certified reports and logs of all tests and inspections conducted shall be submitted to the Construction Project Manager.

**End of Specification**



CITY AND COUNTY OF DENVER  
DEPARTMENT OF PUBLIC WORKS, ENGINEERING DIVISION

## Wastewater Capital Projects Management Standard Construction Specification

---

### 10.7 Cured In Place Pipe

#### 10.7.1 General

This section outlines the guidelines & requirements for the rehabilitation of pipelines and conduits by the Cured in Place Pipe Method (CIPP). CIPP is the installation of a resin-impregnated flexible tube which is inserted into an existing conduit and cured by the use of pressurized steam or circulated water under a hydrostatic head. When complete, the CIPP is continuous and fits tightly to the existing pipe.

#### 10.7.2 Referenced Standards

This section references American Society for Testing and Materials (ASTM) standards, which are made a part of this specification by such reference. All standards shall be the latest edition and revision. The materials, manufacturing, operations, testing, inspection and production of cured in place pipe shall conform to the following standards.

ASTM D638	Standard Test Method for Tensile Properties of Plastics
ASTM D790	Standard Test Methods for Flexural Properties of Unreinforced and Reinforced Plastics and Electrical Insulating Materials
ASTM D2122	Determining Dimensions of Thermoplastic Pipe & Fittings
ASTM D2990	Standard Test Methods for Tensile, Compressive, and Flexural Creep and Creep-Rupture of Plastic
ASTM D5813	Standard Specification for Cured-In-Place Thermosetting Resin Sewer Piping Systems
ASTM F1216-09	Standard Practice and Rehabilitation of Existing Pipelines and Conduits by the Inversion and Curing of a Resin-Impregnated Tube
ASTM F1743	Practice of Rehabilitation of Existing Pipelines and Conduits by Pulled-In-Place

### 10.7.3 Submittals

Unless otherwise specified, the Contractor is responsible to have all submittals transmitted to the Construction Project Manager in sufficient time to allow two weeks for review and acceptance prior to starting the construction or any work by the Contractor. These include, but are not limited to:

- CIPP Health and Safety Plan
- Confined Space Entry Permits
- Corrosion Testing.
- Employee Certifications (NASSCO, OSHA, etc.)
- Felt Certification
- Fire Department Permit
- Installation Procedures
- Laboratory Designation and Accreditation
- Laboratory Testing Results
- Liner and Resin Long Term Performance Studies in Post-installation
- Service Open Notice
- Pre-cleaning (and TV) Notice
- Pre-lining Notice
- Pulling force gauge
- Structural Requirements
- Technical Supervision
- Tube Compliance
- Unanticipated Cancellation Notice
- Video/log sheet sample

#### 10.7.3.1 Installation

Prior to installation by Inversion or the Pulled-in-Place method, the Contractor shall provide the Construction Project Manager with the following as applicable to the specific installation method:

- a. The minimum pressure required to hold the tube tight against the existing conduit and the maximum allowable pressure so as not to damage the tube. A complete log of the pressure (or head level) shall be maintained on the site and be furnished to the Construction Project Manager after each installation.
- b. The maximum allowable force that can be used in pulling the tube into the existing pipeline for each size of line. A complete log of the pulling force used for each line shall be maintained on site by the Contractor and be furnished to the Construction Project Manager after each installation.
- c. Minimum temperature and time required for cure on each size of line, based on installation method.
- d. For CIPP segments which are wet out on site, the Contractor must also submit (in spreadsheet form) information on allowable head pressure, roller spacing and gallons of resin to felt length with respect to diameter so the procedure can be verified on site.

### **10.7.3.2 Health and Safety Plan**

Prior to site work, the Contractor shall provide the Construction Project Manager, for review, a Health and Safety Plan which includes (at a minimum) the following:

#### I) Introduction

- a. Provide project description, the work location and summary of key work activities to be performed.

#### II) Scope and Applicability

- a. Describe the scope of work for the General Contractor and 1<sup>st</sup> tier subcontractors performing the work
- b. Detail the planned site activities
- c. Describe who must adhere and abide by the Health and Safety plan
- d. Detail how site visitors will be addressed

#### III) Key Personnel, Responsibilities and Authority

- a. In relation to Health and Safety, describe the role of project managers, health and safety managers, technical supervisors (10.7.3.4), and other contractor and subcontractor staff.
- b. Provide resumes of Key Personnel, including background and training history.
- c. Identify the name, title, and contact information (phone, email, address) for key personnel.
- d. Identify the name, location, and contact numbers for ambulance, fire, police, hospital, Health and Safety managers (contractor and/or subcontractors), and other key personal or support contacts.

#### IV) Task/Operation Health and Safety Risk Analysis

- a. Identify, on a task specific basis the individual hazard elements that are present including chemical, physical, and biological.

#### V) Qualifications and Training Requirements for all Personnel

- a. Detail specific qualifications and training that are required.
- b. Discuss the frequency of safety and training refreshers.
- c. Detail the requirement for site personnel to read and acknowledge, in writing, their understanding of the Health and Safety plan.

#### VI) Engineering and Administrative Controls

- a. Describe in detail how engineering and administrative controls will be used to protect worker and public safety by preventing chemical exposure, injury, or illness.

- b. List controls in conjunction with each activity identified in the Task/Operation Health and Safety Risk Analysis section above.

#### VII) Personal Protective Equipment (PPE) Requirements

- a. PPE requirements should be listed in conjunction with each activity identified in the Task/Operation Health and Safety Risk Analysis.
- b. Detail applicable standards (e.g., ANSI, NIOSH, ACGIH, OSHA etc)

#### VIII) Health and Safety Monitoring

- a. Detail instruments, samples, and monitoring that will occur both on the jobsite and in response to complaint(s) or inquiries.
- b. Detail who is responsible for performing monitoring
- c. Detail frequency of monitoring
- d. Define the appropriate action levels and thresholds
- e. Describe standard operating procedures for Health and Safety monitoring

#### IX) Site control

- a. Describe work zones, buddy systems, and site security.
- b. Address policies including drug and alcohol policies, personal hygiene requirements, heat and cold stress prevention
- c. Describe task specific site control (e.g., confined space entry protocol, worker photo ID program, etc.)

#### X) Decontamination plan

- a. Eye and hand wash (if applicable)
- b. Site cleanup

#### XI) Emergency Contingency Plan

- a. Medical services
- b. Emergency phone numbers
- c. Personnel Injury
- d. Fire/Explosion
- e. Hazardous Material spill response and onsite location of spill kit
- f. Evacuation
- g. Emergency signals and communication
- h. First aid
- i. Emergency equipment list
- j. Map(s), addresses, and phone numbers of nearest medical facilities

## XII) Appendices

- a. Safety forms (as needed)
- b. Supporting documentation and information
- c. Material safety data sheets (MSDS)

### **10.7.3.3 Weekly Installation Schedule**

The Contractor shall submit a weekly construction schedule, 7 calendar days in advance of the work, to the Construction Project Manager and the Denver Fire Department to include the following information:

1. The specific line number and related manhole numbers as designated in the project plans. The line length and service connection count information must also be included from the preliminary video investigation.
2. The specific date and timeframe each installation will occur. Night and weekend work must be approved by the Construction Project Manager a minimum of 10 days prior to the proposed commencement of the work.
3. The Technical Supervisor's name for the crew(s) that will be doing each specific installation.
4. The method of installation planned for each line in accordance with ASTM F1216 or F1743.
5. The location and schedule of the "wet-outs" in order to permit inspection of the materials and procedures. This information may be submitted separately.

### **10.7.3.4 Technical Supervision**

Due to the technical aspects and complexity of the products used during the installation of CIPP, the Contractor is required to maintain a full time employee with a minimum of five years experience in the CIPP process of rehabilitation. This employee should be at the superintendent level or higher. This employee must be the direct, first line contact for all aspects of the project construction management. Resume and references, and copies of applicable required NASSCO, OSHA, etc. training certificates of this employee shall be submitted to the Construction Project Manager for review and acceptance prior to the start of the project.

### **10.7.3.5 Test Results and Performance Studies**

CIPP sample test results as well as long term performance studies, from an industry recognized independent laboratory, must be submitted for the materials from the specific supplier(s) to be used on the project in accordance with applicable ASTM standards. The CIPP liner material must meet the requirements of ASTM F1216 or F1743 and ASTM D5813 Sections 6 and 8 (Appendix X.1). The resin shall produce CIPP, which will comply with the structural and chemical resistance requirements of ASTM F1216 or F1743. It is required that CIPP samples with and without polyethylene coating meet these chemical testing requirements. The long term performance studies must show the proposed material

consistently meets the required thickness and strength requirements per the Contract Documents.

The Long Term Performance Studies must be submitted and accepted prior to bidding to pre-qualify the prospective bidder. The CIPP liner material used for the project must be the exact same composition of the material used in the Long Term Performance Studies as outlined in this Section. Any deviation in the composition will require that a new Long term Performance Study is completed, submitted and accepted prior to installation.

### **10.7.3.6 Street Occupancy Permits**

The Contractor shall submit, to the Construction Project Manager, copies of the street occupancy permits, including the approved traffic control plans prior to beginning work.

### **10.7.3.7 Digital Video and Log Sheets**

Prior to commencing any site work, the contractor shall submit video quality samples as well as log sheet samples for review and acceptance by the Construction Project Manager. These samples must be in accordance with the following specifications.

### **10.7.3.8 Digital Video and Log Sheets Specifications**

1. After cleaning and lining, the manhole sections shall be visually inspected by means of closed-circuit television. The inspection will be done one manhole section at a time and the flow in the section being inspected will be suitably controlled as specified elsewhere in these Standard Construction Specifications. CCTV inspections shall be performed in accordance with PACP standards including indications of the specific date and time of inspection.
2. The closed-circuit television camera used for the inspection shall be one specifically designed and constructed for such inspection. Lighting for the camera shall be suitable to allow a clear picture of the entire periphery of the pipe. The camera shall be operative in 100% humidity conditions. The camera, television monitor, and other components of the video system shall be capable of producing picture quality to the satisfaction of the Owner's Representative; and if unsatisfactory, equipment shall be removed and no payment will be made for an unsatisfactory inspection.
3. The camera shall be moved through the line upstream to downstream at a moderate rate, stopping when necessary to permit proper documentation of the sewer's condition. In no case will the television camera be pulled at a speed greater than 30 feet per minute. Manual winches, power winches, TV cable, and powered rewinds or other devices that do not obstruct the camera view or interfere with proper documentation of the sewer conditions shall be used to move the camera through the sewer line. If, during the inspection operation, the television camera will not pass through the entire line section, the Contractor shall set up his equipment so that the inspection can be performed from the opposite manhole. If, again, the camera fails to pass through the entire manhole section, the inspection shall be considered complete noted as Survey Abandoned. The contractor is required to notify the Construction Project Manager and further direction will be provided.
4. When manually operated winches are used to pull the television camera through the line,

telephones or other suitable means of communication shall be set up between the two manholes of the section being inspected to insure good communications between members of the crew.

5. The importance of accurate distance measurements is emphasized. Measurement for location of defects shall be above ground by means of a meter device. Marking on the cable, or the like, which would require interpolation for depth of manhole, will not be allowed. Accuracy of the distance meter shall be checked by use of a walking meter, roll-a-tape, or other suitable device, and the accuracy shall be satisfactory to the Construction Project Manager.

6. Documentation of the television results shall be as follows:

- (6.1) Television Inspection Logs: Electronic media location records shall be kept by the Contractor and will clearly show the location, by distance in 1/10 of a foot or nearest cm, from the upstream manhole wall, in relation to an adjacent manhole of each infiltration point observed during inspection. In addition, other points of significance such as locations of building sewers (taps), unusual conditions, roots, storm sewer connections, cracks, fractures, broken pipe, presence of scale, calcium deposits and corrosion (with estimated thicknesses), and other discernible features, as defined in the PACP defect codes, will be recorded on electronic media, and a copy of such records will be supplied to the Construction Project Manager.
- (6.2) Digital photographs of the pipe condition and all defects and service connections (taps) shall be taken by the Contractor. Photographs shall be located by distance in 1/10 of a foot or nearest mm, from the manhole wall, in relation to an upstream manhole.
- (6.3) Electronic media recordings: The purpose of electronic media recording shall be to supply a visual and audio record of problem areas of the lines that may be replayed by the Owner. Each original electronic media recording of conditions and defects will be delivered to the Project Construction Manager upon completion of a specific line section.
- (6.4) All CCTV Inspection shall be performed by CCTV personnel who are trained and certified in the use of NASSCO's Pipeline Assessment and Certification Program (PACP)©.

### **10.7.3.9 Digital Video and Log Sheets Submittal Naming Convention**

The Contractor shall submit all log sheets and digital video files for pre and post installation, together, the week immediately following completion of each work segment. All digital video and log sheets must be submitted electronically, *on a USB Plug and Play device (flash drive or hard drive)*. *Video shall be in MP4 format and logs shall be in .pdf format* All video and logs shall be submitted utilizing the following naming convention:

- a. Video Files and Log Sheets
  - i. Named using the following items sequentially, followed by a space



1. City of Denver Contract Number
2. Line Number From Plans
3. GIS Facility ID From Plans (for each line segment.)
4. Type Of File ('Pre' or 'Post' for Video, 'Pre Log' or 'Post Log' for applicable log sheets)
5. Extension of file (.mp4 or .pdf)

ii. Examples:

1. 2012XXXXX Line72 31814SAGM Post Log.pdf
2. 2012XXXXX Line72 31814SAGM Post.mp4
3. 2012XXXXX Line72 31814SAGM Pre Log.pdf
4. 2012XXXXX Line72 31814SAGM Pre.mp4
5. 2012XXXXX Line73 31825SAGM Post Log.pdf
6. 2012XXXXX Line73 31825SAGM Post.mp4

## 10.7.4 Materials

### 10.7.4.1 Textile Tube

1. The tube shall meet the requirements of ASTM F1216 or F1743 and ASTM D5813 Sections 6 and 8. The finished CIPP shall be fabricated from materials which when cured will be chemically resistant to withstand internal exposure to all types of sewage being conveyed. The textile tube shall be continuous in length for the associated run. The wet-out textile tube shall meet ASTM F1216 or F1743, as applicable, have sufficient strength to bridge missing pipe segments and have a uniform thickness that when compressed at installation pressure will equal the specified nominal tube thickness, with a -5% manufacturing tolerance allowed. The tube shall be fabricated to a size that when installed will tightly fit the internal circumference and length of the original pipe. Allowance should be made for circumferential stretching during installation. The minimum length shall be that deemed necessary by the Contractor to effectively span the distance between respective access points, unless otherwise specified. It is the Contractor's responsibility to verify the CIPP lengths and diameters in the field before fabricating the tube.
2. Prior to installation the outside layer of the tube shall be coated with a translucent plastic coated flexible material that clearly allows inspection of the resin impregnation, or wet-out procedure. The plastic coating shall not be subject to delamination after curing of the CIPP. The tube shall be homogenous across the entire wall thickness containing no intermediate or encapsulated elastomeric layers. No materials shall be included in the tubes that are subject to delamination from the cured CIPP.
3. The wall color of the interior pipe surface of the CIPP after installation shall be notably colored as seen in the field install to insure that the resin has been fully impregnated so that a clear and detailed examination with closed circuit television inspection equipment may be made.

- The wet-out textile tube shall meet ASTM F1216 or F1743, as applicable, shall have a uniform thickness and 5% to 10% excess resin distribution that when compressed at installation pressures will meet or exceed the design thickness after the cure.

**10.7.4.2 Resin**

- The resin/liner system shall conform to ASTM D2990 and ASTM D5813 Section 8.2.2 – 10,000-hour test.
- The resin shall be a general purpose, unsaturated, styrene-based, thermoset resin and catalyst system or epoxy resin and hardener that are compatible with the inversion or pulled in place process as per the requirements of ASTM F1216 or F1743. The resin shall be tinted so that adequate saturation can be readily observed. Only resin with a minimum long term (50 years) Modulus of Elasticity of 48% of the initial Modulus of Elasticity will be accepted.
- The tube shall be impregnated with sufficient amount of resin to insure that the resin will be observed on the outer surface of the tube when squeezed. After the tube is cured, it shall show satisfactory evidence of a fully impregnated tube or the existence of excess resin on the outer surface.

**10.7.4.3 Calibration Hose**

If a calibration hose is required to be used during the process of the installation of the CIPP, the hose shall be wet and vacuum impregnated with sufficient amount of resin prior to inversion to prevent delamination after the curing of the CIPP. Delaminating or failure of the calibration hose will be cause for rejection or complete removal of the CIPP section at the discretion of the Construction Project Manager.

**10.7.4.4 Structural Requirements**

- The CIPP shall be designed as per ASTM F1216, Appendix X.1. The CIPP design shall assume no bonding to the original pipe wall, a fully deteriorated condition, 5% ovality and a conservative groundwater presence over the pipeline. The CIPP cured thickness must meet the required minimum cured nominal thicknesses specified in the table below, or for pipe larger than 18-inches in diameter as specified within the Contract Documents.

Internal Pipe Diameter (inches)	CIPP Minimum Cured Nominal Thickness (mm) Based on Modulus of Elasticity Values	
	Modulus of Elasticity (E) 250,000 psi	Modulus of Elasticity (E) 400,000 psi
8	6	5
10	7.5	6
12	9	7.5
15	10.5	9
18	12.5	10.5
For pipe larger than 18-inches in diameter, the CIPP minimum nominal thickness is specified within the Contract Documents		

2. The layers of the cured CIPP shall be uniformly bonded. It shall not be possible to separate any two layers with a probe or point of a knife blade so that the layers separate cleanly or the probe or knife blade moves freely between the layers; nor shall separation of the layers occur during the required testing.
3. The cured pipe material (CIPP) shall conform to the minimum structural standards, as listed below:

Flexural Stress	ASTM D790	4,500 psi
Modulus of Elasticity	ASTM D790	250,000 or 400,000 psi
Tensile Strength	Pressure Pipe - ASTM D638	3,000 psi

Either of the listed Modulus of Elasticity values noted may be used as long as minimum nominal thicknesses are adhered to in accordance with the table or as noted within the Contract Documents.

### 10.7.5 Quality Control

It shall be the contractor’s responsibility to ensure that the CIPP installed on the project meets all requirements of the Contract Documents and that the final product provided to the City meets all of the City and County of Denver Specifications and is of the highest quality possible.

#### 10.7.5.1 Testing

In the event that the results of any tests do not meet the requirements of the Contract Documents and/or referenced ASTM standards, the Contractor may proceed with the work at his/her own risk and will be required to submit to the Construction Project Manager the proposed changes in the process to meet the required properties of the CIPP.

If any lined pipe segment fails to meet the required properties, the Contractor's attention is directed to General Condition 304 – “Substituted Performance”. At the discretion of the Construction Project Manager and at the Contractor’s own expense, the Contractor will be required to remove and replace any lined pipe segment, without damaging the host pipe, or install another liner inside of the liner that failed in order to meet the specified requirements of the Contract Documents

The City may elect at any time to decrease or increase the frequency of these sample and testing requirements.

##### 10.7.5.1.1 On-Site Thickness Testing

A minimum of 2 (two) samples will be collected or 2 locations tested using ultrasonic methods, for on-site thickness at each installation by the contractor. All samples collected for testing shall be restrained with equivalent diameter pipe to match the actual field installed liner. A minimum of eight measurements at evenly spaced intervals around the circumference (internal or external based on method) of the pipe will be made to ensure that

minimum and maximum thicknesses have been achieved. For pipe diameters fifteen inches or greater, a minimum of sixteen evenly spaced measurements shall be recorded. Any plastic coatings or CIPP layers not included in the structural design of the CIPP must be deducted from the measured thickness value. The average thickness will be calculated using all measured values and shall meet or exceed the minimum required design thickness. Additionally, the minimum wall thickness measured at any one point around the circumference shall not be less than 87.5% of the specified design thickness as specified within the Contract Documents.

The wall thickness will be measured in accordance with the applicable sections of ASTM D2122 or ASTM E797 and shall incorporate the following, as applicable:

1. For onsite samples collected for testing: A cylindrical anvil tubing micrometer accurate to +0.02 mm (+0.001 inch) will be used. The minimum wall thickness tests will be performed by the Construction Project Manager (or assigned field representative) from the two samples at each installation. All costs associated with providing the required samples shall be borne by the Contractor.
2. For onsite testing using Ultrasonic methods: Testing will be performed by the ultrasonic pulse echo method, in accordance to ASTM E797. Measurements will be taken and calculated at both ends of the pipe run, around the internal circumference of the installed CIPP and at a distance of 12 to 18 inches from the end of pipe, as noted in item 1 above. The ultrasonic method will utilize a flaw detector with A-scan display and a direct thickness readout as defined in 6.1.2 of ASTM E797. A calibration block shall be manufactured from the identical materials used in the installed CIPP to calibrate sound velocity through the liner. Calibration of the transducer shall be performed daily in accordance with the equipment manufacturer's recommendations.

If the deviation in thickness of any one sample is less than 5% (five percent), no payment adjustment will be required. If the deviation in thickness is measured to be between 5%-10% (five percent and ten percent) an adjustment of 10% (ten percent) reduction of the liner unit bid cost will be applied. If the deviation in thickness is greater than 10% (ten percent), the entire run will be rejected and removed and replaced solely at the Contractor's expense.

#### **10.7.5.1.2 Allowable Pulling Force**

Prior to installation, the Contractor shall submit to the Construction Project Manager the maximum allowable force, per the material manufacturer, that can be used in pulling the tube into the pipe without rupturing or diminishing the diameter and/or the thickness of the tube. Such pulling force shall be monitored at all times during the installation operation with a gauge that is available for viewing by the City and the tube shall be rejected and removed if the allowable pulling force is exceeded.

#### **10.7.5.1.3 Allowable Elongation of Flexible Tube**

Prior to installation, the flexible tube shall be measured and marked equal to the installation run (distance between manholes less one manhole diameter). After the completion of installation, the length of the flexible tube outside of the installation run (face of the manhole to the mark) shall be measured. This length or elongation shall not exceed

3% (three percent) of the original length of measured flexible tube. In the event that this length is exceeded, the entire run length may be rejected and permanently discarded, the Construction Project Manager may order an additional tube to be inserted at no cost to the City, or may accept the elongated tube, but reduce the price paid for the work by 5% (five percent) for every percent elongation above the 3% (three percent) allowable tolerance, as provided by General Condition 304, Substituted Performance. Acceptance will be at the sole discretion of the Construction Project Manager.

#### **10.7.5.1.4 Laboratory Testing**

At the start of construction, at least two restrained CIPP field samples will be taken and submitted for laboratory testing. CIPP samples shall be prepared and tested in accordance with ASTM F1216. These samples will be taken by the approved independent lab, with chain of custody documentation regarding each sample.

A CIPP sample is required to be prepared for each installation segment, using one of the following two methods (depending on the size of the host pipe):

1. For pipe sizes of 18 inches or less: the sample will be cut from a section of cured CIPP at an intermediate manhole or at the termination point. If the sample is taken at a termination point the CIPP must have been inverted through a restrained, like diameter pipe which has been held in place by a suitable heat sink, such as sandbags.
2. For pipe sizes greater than 18 inches and areas with limited access: the sample must be fabricated from material taken from the tube and the resin/catalyst system used. This fabricated sample must be cured in a clamped mold which is placed in the down tube (when curing using circulating hot water) or in the silencer (when curing using steam). If approved by the Construction Project Manager, this method can be used for preparing a test sample on any size of CIPP in situations where preparing samples in accordance with section F1216-09, sec. 8.1.1 is not possible due to physical constraints.

Samples must identify the City contract number, project name, line number, date sample was taken and the specified thickness requirement. Testing for cured liner thickness, modulus of elasticity, flexural stress and tensile strength shall be performed by a Certified Independent laboratory approved by the Construction Project Manager. Test results are to be submitted to the Construction Project Manager and all costs of tests shall be included in the related bid price unless specified elsewhere in the Contract Documents. The Contractor shall take samples from the first week's installation and have the short term tests completed and results to the Construction Project Manager prior to application for the first pay estimate. Additional testing will commence at intervals required by the Construction Project Manager.

Additional laboratory testing, at the City's expense, may be requested as frequently as every CIPP installation, at the discretion of the Construction Project Manager. The Contractor will be reimbursed for additional testing at the Contract unit bid price. At the option of the Construction Project Manager any sample taken by the Contractor may be sent to an independent laboratory for similar testing.

#### **10.7.5.1.5 Infiltration Test**

If the ground water level is above the top of the pipe throughout the length being reconstructed, the Construction Project Manager, at his/her discretion, may order that an infiltration test be performed. The maximum allowable infiltration shall be 50 gal per day/inch dia/mile (.95 gpd/inch/100 ft.). If the infiltration is found to exceed the prescribed amount, the Contractor shall make the appropriate repairs as approved by the Construction Project Manager. Additional infiltration tests will be performed until acceptable results are obtained.

Unless otherwise specified, infiltration will be measured by a subcontractor specializing in CIPP testing who is mutually agreed upon by the City and Contractor. Payment for this testing is at the City's expense and will be handled by change order.

#### **10.7.5.1.6 Exfiltration Test**

In the absence of ground water, the Construction Project Manager, at his/her discretion, may order an exfiltration test be performed in accordance with these specifications. The allowable rate of exfiltration shall be equal to the limits of infiltration stated above. Each section of CIPP will be tested between successive manholes by closing the lower end of a sewer and the upper manhole(s) to the proper level with water. The water level in the upper manhole shall be a minimum of 4 feet above the level of the ground water.

For the purposes of exfiltration leakage, manholes shall be considered to be equivalent length of pipe equal to the diameter of the manhole (i.e. 48, 60 or 72 inch diameter). Air pocket entrapment shall be avoided when filling the line with water. Once filled with water, the system shall be allowed to stabilize for a period of two hours before starting the test. Exfiltration leakage rate is determined by measuring the amount of water required to maintain a constant level in the upper manhole. Test duration is to be no less than two hours.

If the leakage, as shown by the test, exceeds the allowable value, the Contractor shall make the necessary correction at his expense to reduce the exfiltration to within the permissible limits. The Contractor shall furnish all water, material and labor required to perform the test. All tests shall be made in the presence of the Construction Project Manager.

### **10.7.6 Public Information and Notification**

All written notices shall be issued on current City and County of Denver letterhead templates, prepared in a professional manner and must be approved by the Construction Project Manager prior to distribution. All contact with the Public shall be executed in a business professional manner, including adhering to professional standards regarding courtesy, grooming and maintaining visible/legible photo identification.

1. The Public Information and Notification program shall at a minimum, require the Contractor to be responsible for contacting each home or business affected by the sewer construction and informing them of the work to be done in all of the following ways: Written notice shall be delivered a minimum of 48 hours in advance of the Pre-clean and Video; and again on the day of installation, to each home or business describing the work, schedule, how the construction affects them, and a local

telephone number of the Contractor they can call to discuss the project or any problems that may arise.

2. Personally contacting each home and business owner on the day of pre-installation inspection of the sewer and coordinating with that owner the verification of their existing service connection. If the owner is unavailable, other arrangements shall be made for existing service connection verification.
3. In the event that a written notice cannot be left at the home or business, the contractor shall personally contacting each home or business owner the day prior to beginning work on the section of sewer to which they are connected.
4. Personally contacting any home or business owner which cannot be reconnected within the time stated in the Written Notice. Anticipated service tap reconnection time shall be noted within another notice.
5. Provide written notice with the time of reactivation posted on the front door of a residence or business.
6. Upon request by residents and businesses affected by the work, portable toilets shall be furnished and serviced by the Contractor. Reimbursement for the costs of these items will be covered through change order with the Construction Project Manager.
7. Businesses which require special accommodations, such as night or weekend work, must be identified at least 10 days prior to the proposed scheduled work. The Construction Project manager shall be notified and kept apprised of the coordination to meet these special accommodations.

## **10.7.7 Installation**

### **10.7.7.1 Access Points**

The City has shown all existing manhole access points on the Contract Documents, to the best of its knowledge. It is the Contractor's responsibility to fully examine the project site to verify the location of existing manholes and to determine if all manholes are accessible, as necessary for completion of the work. It will be the Contractor's responsibility to notify the Construction Project Manager far enough in advance of the CIPP lining process to allow time for the City to make necessary repairs and provide access to the manholes that are not accessible. The Contractor will reschedule the work as needed so that repair work, either by the City or by the Contractor, can be completed.

### **10.7.7.2 Pre-Installation Inspection**

Inspections of pipelines shall be performed by experienced personnel trained in locating and identifying defects, breaks, obstacles, and service connections by closed circuit television. Certification by NASSCO, PACP program is preferred for inspection personnel. The pre-inspection of pipelines shall also determine active service connections, the addresses served (both visible on the digital recording and audible), as well as which service

---

connections are opened, capped or misaligned. Only active service connection and laterals shall be re-established unless directed otherwise by the Construction Project Manager.

The interior of the pipeline shall be carefully inspected to determine the location of any conditions which may prevent proper installation of the CIPP. It is the Contractor's responsibility to notify the Construction Project Manager of any conditions which may prevent proper installation of the CIPP. These types of conditions shall be recorded and submitted digitally, as described elsewhere in these specifications, to the Construction Project Manager within 5-calendar days of observance, to allow for remedial action and rescheduling of installation for that section of CIPP.

#### **10.7.7.3 Bypassing Sewage**

The Contractor shall provide for the flow of sewage around the section or sections of pipe designated for reconstruction. All costs incurred for bypass pumping are included within the "Cured-In-Place-Pipe" bid item within the contract, except when otherwise noted. The bypass shall be made by plugging the line at an existing upstream manhole or adjacent system. The pump and bypass lines shall be of adequate capacity and size to handle the flow with backup pumps onsite. Bypass pumps must be monitored at all times. Leaking equipment will not be permitted. Bypass pumping must be provided for all mainline and service line flows affected by construction. Wastewater shall not be allowed to spill into storm drains, street gutters, or open excavations. Any spills that occur must be addressed immediately and in full conformance with local regulations and requirements. The Construction Project Manager shall be notified immediately and the Contractor shall bear all costs associated with any spills.

#### **10.7.7.4 Cleaning of the Sewer Line**

The Contractor shall be required to remove all existing internal debris from the sewer line with the use of water jet, and/or grinding equipment that is accepted by the Construction Project Manager. The cleaning operation shall remove any and all existing debris so that each pipe joint can be thoroughly inspected and successfully reconstructed or rehabilitated. Excessively hard deposits that cannot be removed by regular cleaning equipment or grinding which require special tools to remove will be paid for negotiated separately by the City.

All sludge, dirt, sand, rocks, grease, and all other solid or semi-solid material resulting from the cleaning operation shall be removed at the downstream manhole of the section being cleaned. Passing material from one manhole section to another shall not be permitted.

All such debris resulting from cleaning operations shall be removed from the site and disposed of in a proper manner. The Contractor shall bear all costs associated with testing of debris and proper dumping. Dumping of the debris shall be in accordance with all local, state, and federal regulations. The City will negotiate for costs associated with material disposal if Hazardous Wastes are encountered during testing.

At the end of each work day, all debris shall be removed from the downstream manhole and from the construction site. No debris shall be left at the construction site unattended by the Contractor. Under no circumstances will the Contractor be allowed to accumulate



debris beyond the stated time limit. In the event the Contractor leaves debris unattended at the construction site beyond the stated time, the Contractor will not be allowed to proceed with the work until the debris is properly removed.

During all sewer cleaning operations, precautions shall be taken to protect the sewer lines from damage that might be inflicted by improper use of cleaning equipment. Precautions shall be taken to ensure that the cleaning operation will not cause any damage or flooding to public and/or private property being served by the sewer line section involved. The Contractor shall bear all costs associated with flooding, damage to basements or structures, adjacent utilities and the City's sewer.

#### **10.7.7.5 Line Obstructions**

It shall be the responsibility of the Contractor to clear the line of obstructions such as solids and roots that will prevent the installation of the CIPP. If the pre-installation inspection reveals an obstruction such as a protruding service connection, dropped joint, collapse or obstruction that will prevent the rehabilitation process and cannot be removed by conventional sewer cleaning equipment, grinding or extended tap cutting, then the Contractor shall notify the Construction Project Manager immediately. These conditions shall be recorded and a digital video file and log sheet must be submitted to the Construction Project Manager so that the existing conditions are documented and may be reviewed to determine the extent of repair required prior to CIPP installation. The Construction Project Manager will notify the Contractor upon completion of required repair(s), at which time the Contractor shall perform sewer line cleaning and a pre-installation inspection prior to CIPP installation.

#### **10.7.7.6 Methods**

All bidders proposing to use the CIPP process for a project must use a method that has been approved by the City prior to bid opening. All approved CIPP methods must meet these Standard Construction Specifications. Any proposed deviation from these Standard Construction Specifications must be submitted in writing for acceptance at least eight calendar days prior to the bid opening. CIPP installation shall be in accordance with ASTM F1216, Section 7 for the Inversion Method, or Section 6 of ASTM F1743 for the Pulled-In-Place Installation Method, with the following requirements:

1. The Contractor shall designate a location where the tube will be impregnated prior to installation. The Contractor shall notify the Construction Project Manager of proposed "wet-outs" in order to inspect the materials and procedure. A resin and catalyst system compatible with the requirements of this method shall be used.
2. Once inversion has started, the pressure shall be maintained between the minimum and maximum pressures, as set by the liner's manufacturer, until cure completion. A continuous, constant pressure must be maintained for all air inversion steam cure (AISC) installations. If pressure is lost at any time during installation/cure (for inversion or pulled in place methods), the City may request that the CIPP product be removed and the line segment re-inspected, at the contractor's expense, prior to allowing re-installation and curing.

3. The Contractor shall pull or invert the flexible tube through the existing sewer line in a method which has been reviewed and approved by the Construction Project Manager. The Contractor will not be allowed to use water to float the inserted flexible tube into the existing sewer line. Immediately after installation of the tube, a heat source will be applied to start the curing process. Constant pressure shall be maintained until the tube has completely cured out with continuous monitoring of the confined space during the curing procedure to ensure that the LEL is not exceeded.
4. The heat source shall be fitted with suitable monitors to gauge the temperature of the incoming and outgoing heat supply. Another such gauge shall be placed at the remote manhole to determine the temperature at that location during cure. The Contractor must maintain an on-site written log during the CIPP curing process for each installation, tracking temperature, pressure (for steam cure) and curing time. This log must be available for review at any time by the Construction Project Manager. If air pressure and steam are used, a Safety Gas Detector shall be used to ensure that it does not reach the explosive limit.
5. As noted within the submittals portion of this specification, before the installation process begins, the Contractor shall submit to the Construction Project Manager, the minimum pressure required to hold the tube tight against the existing conduit (including considerations for external ground water pressure, if present) and the maximum allowable pressure to avoid damaging the tube. This data shall be obtained by the Contractor from the tube manufacturer.

If the CIPP is installed via inversion, the pressure shall be maintained between the minimum and maximum pressures until the entire operation has been completed (inversion and cure). If the CIPP is installed using the pulled-in-place method, the pressures shall be maintained, after initial inflation, between the minimum and maximum pressures until the entire operation has been completed (inflation and cure).

If the pressure drops below the recommended minimum at any time during installation or curing of the CIPP, the liner should be removed and the host pipe re-inspected for dislodged pipe fragments or fallen debris which may cause bulging or protrusions within the cured CIPP. In addition, under the above circumstances, the CIPP product should be inspected for lifts or delaminations and evaluated for its ability to fully meet the applicable ASTM F1216 and F1743 requirements. Should the pressure deviate from within the range of minimum and maximum pressures, the installed tube may be rejected and the Contractor will be responsible for the removal of the CIPP without damage to the host pipe and replacement with new CIPP at no additional cost to the City.

Once the cure has started and dimpling for laterals is completed, the required pressures shall be sustained until the cure has been completed. A complete log of the pressures shall be maintained on the site and furnished to the Construction Project Manager after each installation.

6. The plastic coating of the tube shall be translucent to allow visual proof that the resin has wet out the entire tube and that there are no dry areas.

7. The Contractor shall maintain a log on site for each installation section documenting elongation, thickness and pulling force. These logs shall be submitted weekly to the Construction Project Manager.
8. The finished CIPP shall be continuous over the entire length of an installation run between two manholes and be free, as commercially practicable, from visual defects such as foreign inclusions, dry spots, pinholes, folds and delamination.
9. If the CIPP fails to make a tight seal at each manhole, the Contractor shall apply Hydrophilic Seals. The Contractor shall provide a submittal to the Construction Project Manager for approval on either a gasket or a non cementitious (epoxy) grout.
10. Individual installation runs can be made over one or more manhole sections as determined in the field by the Contractor. The maximum allowed installation run is 1,200 feet. Intermediate manholes will be reopened as directed by the Construction Project Manager.

#### **10.7.7.7 Sewer Service Connection and Reactivation**

The Contractor shall determine if a service connection is active prior to rehabilitation of the sewer. Only active service connections and laterals shall be re-established. All costs incurred to verify active service connections are included within the "Cured-In-Place-Pipe" bid item within the contract. No additional payment for verification shall be considered.

After the curing of the CIPP has been completed, the Contractor shall reopen and restore the existing active service connections and branch connections. It is the intent of these Standard Construction Specifications that the active service connections and branch connections be reopened without excavation. When the pipe size is too small to facilitate direct manned reactivation, a remotely controlled cutting device, monitored by a close circuit television camera shall be used. The cutting device is required to re-establish service connections to not greater than 100% (one hundred percent) capacity, and not less than 95% (ninety five percent) capacity, while conforming to the shape of the existing opening. A smooth, or brushed, surface is required to prevent debris or solids from accumulating at the opening. Perforated services connections will be considered damaged and will need to be repaired. The Contractor shall be responsible for completing point repairs of any active service connections that are damaged or misaligned during reactivation procedures. These point repairs shall be completed as directed and approved by the Construction Project Manager and all costs shall be borne by the Contractor.

The Contractor shall certify he/she has a minimum of 2 (two) complete working cutting devices, plus spare key components on the site before each installation.

All solid or semi-solid material resulting from reactivation of the service connection or manhole cut outs shall be removed at the downstream manhole of the section being reactivated. Passing material from one manhole section to another shall not be permitted.

Service connections shall not remain out of service for more than 12 hours at a time, without the Contractor providing some means of temporary facilities or hotel accommodations for the affected residents or property owners.

### **10.7.8 Post Installation Inspection**

Post installation video inspection of all CIPP line segments shall be completed by the contractor and recorded using closed circuit television in accordance with ASTM F1216 or F1743. The post inspection of pipelines shall be performed in a manner which allows the invert to be clearly viewed and inspected (i.e. no water flow). The recorded video must show that all active service connections have been reactivated, the addresses served (both visible on the digital recording and audible), as well as any inclusions or visual defects present. All service connections and laterals which are not plugged or capped shall be re-established unless directed otherwise by the Construction Project Manager. The contractor shall review all post inspection videos and notify the City immediately of any visual defects, inclusions, or issues with the installation. Digital video records shall be submitted, as specified elsewhere in these standards.

### **10.7.9 Clean-Up**

The Contractor shall reinstate all project areas affected by their operations to an equal or better condition than existing upon completion of the CIPP installation. All restoration must be completed prior to submitting that section of CIPP for consideration for payment.

### **10.7.10 Record Documentation**

#### **1. Digital Video and Log Sheets**

The Contractor is required to provide pre and post video files, as well as associated log sheets, for all pipe segments rehabilitated under the contract. All video and log sheets must be submitted to the City and County of Denver. All digital video files shall be submitted in .mp4 format and log sheets shall be submitted in .pdf format. All files will be labeled in accordance with the instructions provided by the Construction Project Manager.

Pre and post inspection log sheets and digital video should be submitted together the week immediately following completion of each work segment, unless the contractor is submitting pre-inspection results separately to convey potential problem areas to the Construction Project Manager. Log sheets and digital video files not submitted at least 5 business days prior to a pay estimate cut-off date will not be considered for payment until the following month. It is the Contractor's responsibility to submit digital video media and log sheets in a timely fashion and as outlined in these specifications.

#### **2. Redline Drawings**

A final set of red-lined drawings shall be submitted by the Contractor on a clean, full size set of project plans for As-Built creation purposes prior to processing final

payment and releasing remaining retainage. A .pdf copy of a clean set of project plans may be obtained from the Construction Project Manager upon request.

The red-lined drawings shall include the following: location and size of all pipe segments rehabilitated, the location of all restored service connections (showing distances from the downstream manhole), and the field recorded length of each rehabilitated segment (face of manhole to face of manhole). Providing inaccurate or incomplete record information is reason for withholding of progress payment as outlined in the General Contract Conditions.

#### **10.7.11 Patents**

The Contractor and the Contractor's suppliers shall warrant and save harmless the City against any and all claims, potential litigation involving patent infringement, copyright violations and any loss thereof.

**End of Specification**



CITY AND COUNTY OF DENVER  
ENGINEERING DIVISION

## Wastewater Capital Projects Management Standard Construction Specification

---

### 10.20 Pipe Bursting

#### 10.20.1 Intent

It is the intent of this specification to provide for the replacement of existing pipelines and conduits by bursting or crushing the existing pipeline and replacing it with either the same size or larger diameter pipe.

#### 10.20.2 Methods

All bidders on this project must construct the Trenchless Replacement of Sanitary Sewers with a process that has been approved by Wastewater Capital Projects Management prior to bid opening.

All approved methods must meet these Standard Construction Specifications. Any proposed deviation from these Standard Construction Specifications must be submitted in writing for acceptance at last ten (10) calendar days prior to the bid opening. Any and all departures from these Standard Construction Specifications must be pointed out and shown on the material submitted.

Special Condition SC-8, **Substitution** of these Specifications refer to substitution of processes other than herein approved.

#### 10.20.3 Inspection of Pipelines

Inspections of pipelines shall be performed by experienced personnel trained in locating breaks, obstacles, and service conditions by closed circuit television. The inspection of pipelines is also to determine active service connections and the addresses which they serve. A videotape and suitable log shall be kept for later reference by Wastewater Capital Projects Management.

#### 10.20.4 Public Relations

The Public Information and Notification program shall as a minimum require the Contractor to be responsible for contacting each home or business connected to the sanitary sewer and informing them of the work to be done, and when the sewer will be off-line and the following:

#### **10.20.4.a**

Written notice to be delivered to each home or business describing work, schedule, how it affects them, and a local telephone number of the Contractor they can call to discuss the project or problems.

#### **10.20.4.b**

Personal contact on the day of pre-installation inspection of the sewer. Each lateral shall be verified by having the homeowner run water down their drain. If the homeowner is unavailable, other arrangements shall be made to drain water through the lateral.

#### **10.20.4.c**

Personal contact and written notice the day prior to beginning work on the section of sewer to which they are connected.

#### **10.20.4.d**

Personal contact with any home or business which cannot be reconnected within the time stated in the written notice.

#### **10.20.4.e**

If so required by a served business, portable toilets for their use by their employees will be furnished and serviced by the Contractor. The costs of these items are considered to be included in the cost of CIPP. No additional payment will be made by the City.

#### **10.20.4.f**

The Public Information and Notification Program shall include the minimum of the above. A complete program shall be submitted in writing to the Construction Project Manager.

### **10.20.5 Approved Material for Trenchless Replacement of Sanitary Sewers**

#### **10.20.5.a Materials**

High Density Polyethylene Pipe (HDPE) shall conform to requirements of Type III, Class C, Category 5, Grade P34 as defined in the latest revision of ASTM D-1248. All solid wall HDPE pipe and fittings shall be manufactured in accordance with ASTM F-714. Pipe and fittings shall be made from virgin high density plastic compounds, with no rework compound except that obtained from the manufacturer's own production of the same formulation, which comply with the requirements for a minimum cell classification of PE 345434C as defined by ASTM D-3350. HDPE pipe shall have an inside surface in light color (e.g. natural, white, green, etc.) to allow light reflection for television inspection.

### 10.10.5.b Physical Properties

Pipes, fittings and joints shall meet the following minimum requirements at the time of installation:

Density	0.941 gm/cc	ASTM D-1505
Melt Index	< 0.15 gm/10 min.	ASTM D-1238
Initial Flexural Modulus	110,000 psi	ASTM D-790
Long-Term Flexural Modulus	28,200 psi	Continuous load duration of 50 years at design load conditions, certified by manufacturer.
Initial Flexural Strength	3,000 psi	ASTM D-790
Long-Term Flexure Strength	1,500 psi	Continuous load duration of 50 years at design load conditions, certified by manufacturer.
Environmental Stress Cracking Resistance	F20=192	ASTM D-1693, Test Condition C (failure % = hours).
Hydrostatic Design Basis	1,600 psi	ASTM D-2837
Color & Ultraviolet Stabilizer	Black, with 2% carbon black	ASTM D-3350

### Certification

Manufacturer shall provide certification that the pipe and fittings meet the minimum specified physical properties, and has sufficient ultraviolet stabilizer for a minimum two (2) years storage life.

### Workmanship

The pipe and fittings shall be homogeneous throughout and free of any blemishes, wrinkles, ribs, protrusions, holes, visible cracks, foreign materials, blisters or other deleterious faults or any defects.

### 10.20.5.c Joints

Sections of HDPE pipe shall be assembled and joined on the job site. Jointing shall be accomplished by the heating and butt-fusion method in strict conformance with the manufacturer's printed instructions. It is the sole responsibility of the Contractor to provide an acceptable water-tight butt-fusion joint. Joint strength shall be equal to or greater than the pipe and shall indicate a ductile rather than brittle fracture when tested. If sectional HDPE pipe is used, it shall be joined in accordance with the manufacturer's recommendation for a leakproof, stab joint method using EPDM O-ring synthetic elastomer gaskets.



Where excavations for HDPE pipe installation are made between manholes, pipe ends shall be jointed by butt-fusion joints, or when recommended by the pipe supplier, with a full circle seal clamp made of stainless steel hardware and a rubber sleeve. Seal clamps shall be manufactured by Rockwell, Dresser, or approved equal. The minimum clamp length shall be fifteen inches (15”).

#### **10.20.5.d Saddles**

Reconnection of service laterals to installed HDPE pipe shall be accomplished using heat fusion saddles. Heat fusion saddles shall be made of polyethylene pipe that meets the minimum specified physical properties and is suitable for fusion welding. Fusion saddles shall be Branch Saddle as manufactured by Driscopipe®, Miller®, Dupont®, or approved equal.

#### **10.20.5.e Flexible Couplings**

Connections to existing service laterals shall be made using flexible couplings. All flexible couplings shall conform to ASTM C-425 and shall be as manufactured by Fernco® Joint Sealer Co., DFW® Plastics, Inc., or approved equal.

#### **10.20.5.f Restrained Joint Polyvinyl Chloride (PVC) Pressure Pipe**

##### **10.20.5.g Material**

Restrained Joint PVC Pressure Pipe shall conform to the requirements of the latest revision of ASTM D-2241. All restrained joint PVC pipe and fittings shall be manufactured from a specially formulated PVC compound which contains impact modifiers and ultraviolet inhibitors. In accordance with ASTM D-1784, all pipe and fittings shall be made from a compound utilizing Type 1, Grade 1, 2000 psi hydrostatic design stress material, Class 12454-B.

##### **10.20.5.h Physical Properties**

Pipe, fittings and joints shall meet the following minimum requirements at the time of installation:

Izod Impact	1.15 ft-lb./in. of notch	ASTM D-256
Tensile Strength	7,000 psi	ASTM D-638
Modulus of Elasticity	40,000 psi	ASTM D-638
Deflection Temperature	158° F	ASTM D-648
Chemical Resistance	B	ASTM D-543
Elongation	150%	ASTM D-638
Flammability	Self-Extinguishing	ASTM D-635

## **Certification**

Manufacturer shall provide certification that the pipe and fittings meet the minimum specified physical properties.

## **Workmanship**

The pipe and fittings shall be homogeneous throughout and free of any blemishes, wrinkles, ribs, protrusions, holes, visible cracks, foreign materials, blisters or other deleterious faults or any other defects.

### **10.20.5.i Joints**

Sections of PVC pipe shall be assembled and permanently joined on the job site. Jointing shall be accomplished by use of machined grooves on the pipe and in the joining coupling which, when aligned, allow a spline to be inserted, resulting in a fully circumferential restrained joint that locks the pipe and couplings together. A flexible elastomeric seal (O-ring) in the coupling provides a hydraulic pressure seal.

Joints shall meet the requirements of ASTM D-3139, and the O-rings shall meet the requirements of ASTM F-477. Couplings shall be provided with factory installed O-rings.

### **10.20.6 Bypassing Sewage**

The Contractor shall provide for the flow of sewage around the section or sections of pipe designated for reconstruction. The bypass shall be made by plugging the line at an existing upstream manhole or adjacent system. The pump and bypass lines shall be of adequate capacity and size to handle the flow. Bypassing includes all mainline and service line bypassing required. Wastewater shall not be allowed to spill into storm drains, street gutters, or open excavations. Any spills that occur must be taken care of properly and immediately. The City shall be notified immediately and the Contractor shall bear all costs associated with any spills.

### **10.20.7 Service Connections**

After the trenchless replacement of the pipe has been completed, the Contractor shall reopen / restore the existing active service connections and branch connections. No service connection shall remain out of service for more than twenty-four (24) hours at a time without the Contractor providing some means of temporary facilities or hotel accommodations for the residents.

No additional payment will be made for excavations for the purpose of reopening connections and the Contractor will be responsible for all costs and liability associated with such excavation and restoration work.

### **10.20.8 Reports**

The Contractor will provide the Construction Project Manager with a color videotape. The tape will include both the before and after conditions, and restored connections with addresses each connection serves, in audio, and on the videotape. Copies of all certified reports and logs off all tests and inspections conducted shall be submitted to the Construction Project Manager.

### **10.20.9 Clean-up**

Upon acceptance of the installation work and testing, the Contractor shall reinstate the project area affected by this operation.

### **10.20.10 Payment**

Payment for work included in this section will be in accordance with the prices set forth in the proposal for the quantity of work performed. Progress payments will be made monthly based on the work performed during that period.

### **10.20.11 Patents**

The Contractor and the Contractor's supplier shall warrant and save harmless the City and Wastewater Management Division against any and all claims and potential litigation involving patent infringement and copyright violations and any loss thereof.

**End of Specification**



CITY AND COUNTY OF DENVER  
ENGINEERING DIVISION

## Wastewater Capital Projects Management Standard Construction Specification

---

### 11.0 Structures and Appurtenances

#### 11.0.1 General

Except where otherwise indicated in these Standard Construction Specifications, manholes, special structures, box culverts, vaults, storm inlets, and other miscellaneous structures and appurtenances shall conform to the details included in these Specifications or as shown on the drawings. All concrete and reinforcing for structures shall conform to the requirements set forth in the most recent Standard Specifications for Road and Bridge Construction, by the Colorado Department of Transportation, as described below, or otherwise modified herein.

##### 1. CDOT Section 601 Structural Concrete

*CDOT Section 601 Structural Concrete shall be utilized and revised as follows:*

Class D Concrete will be utilized for all structural concrete work; using  $\frac{3}{4}$ " nominal sized aggregate (100% passing the 1" sieve and 90% to 100% passing the  $\frac{3}{4}$ " sieve).

Type II Portland Cement will be used.

*Subsection 601.05 shall be revised to include:*

The concrete used in upper deck slabs shall have a maximum substitution of fly ash for Portland cement of 10% by weight.

*CDOT Subsection 601.19 shall be revised as follows:*

Method of measurement shall be deleted. Method utilized will be as specified elsewhere in the Contract Documents.

*Subsection 601.20 shall be revised as follows:*

Basis of payment will be deleted. Basis of payment utilized will be as specified elsewhere in the Contract Documents.

##### 2. CDOT Section 602 Reinforcing Steel

*CDOT Section 602 Reinforcing Steel shall be utilized and revised as follows:*

Subsection 602.02 shall be revised as follows:

Epoxy coated reinforcing steel will not be utilized unless otherwise specified in the Contract Documents.

*Subsection 602.07 shall be revised as follows:*

Method of measurement will be deleted. Method utilized will be as included otherwise in the Contract Documents.

*Subsection 602.08 shall be revised as follows:*

Basis of payment will be deleted. Basis of payment will be as included otherwise in the Contract Documents.

## **2. Special Design**

All special structures in the City and County of Denver that deviate from the standard details shall be submitted in writing, to the City Construction Project Manager. This includes items such as inlets, oversize structures, and/or precast vaults. If the Construction Project Manager will allow the special design a structural design is required by a Professional Engineer licensed in the state of Colorado. At a minimum the design loading and load factors shall comply with the following:

Live Load - AASHTO LRFD, HL-93 Tandem, and Colorado Permit Truck

Dead Load - vertical earth load = 120 lbs/cu.ft., horizontal earth load = 60 lbs/cu.ft.

Wearing Surface – 12 in. thick concrete pavement

Live Load Surcharge on Exterior Walls = 2 ft. of Earth (120 psf)

Load Factors - Latest edition of AASHTO Bridge Design Specifications

Environmental engineering durability factor (Sd) per ACI 350-06

## **11.0.2 Manholes**

Except where otherwise specified or indicated on the drawings, storm and sanitary sewer manholes shall conform to the requirements as set forth below. Manholes 6' (six foot) in diameter or smaller shall be constructed of precast concrete or cast-in-place concrete as outlined in the Wastewater Management Division Standard Detail Drawings or within the Contract Documents. Type B and Type P manholes shall be cast in place only, unless specified otherwise in the contract documents. All manholes and related component items shall be designed for AASHTO HS20 loading.

### **11.0.2.1 Size**

The minimum internal diameter of the manhole barrel shall be as follows for both storm and sanitary sewer installations (please refer to the Wastewater Management Division Standard Detail Drawings).

Pipe Size	MH Barrel I.D.	Standard Top Section	Standard Detail
30" dia. and smaller	4'-0"	Concentric Cone	S501.1
30" to 36"	5'-0"	Concentric Cone	S501.1
42" and larger	Type B or P or Special Detail	As detailed	S503 S504

**Note:** Standard ring and cover is 24 inch diameter.

### 11.0.2.2 Materials

The materials to be used in the construction of sewer manholes shall conform to the following requirements:

#### 1. Precast Reinforced Concrete Manhole Sections

Precast manhole sections including barrels, cones, flat tops, etc. shall be manufactured in accordance with ASTM C-478, Precast Reinforced Concrete Manhole Sections. All cones furnished shall be concentric except for manholes with less than 4 feet of cover, which shall be flat top. Concrete used in precast manhole bases shall have a minimum 28 day compressive strength of 5000 psi, and shall be constructed of Type II, Portland cement. Welded wire fabric used in precast manhole sections shall be as specified in ASTM C-478. These precast manhole elements are intended to be utilized as components of non-pressurized sewer and manhole systems only. Pressure systems were warranted and authorized by the Division will require special design pressure manholes, joints, and other appurtenant items.

#### 2. Cast-in-Place Concrete Manholes

All concrete used in construction of cast-in-place manholes and bases shall be CDOT Class D. Construction shall be in conformance with the Wastewater Management Division Standard Detail Drawings.

#### 3. Structural Reinforcement

All structural reinforcement shall be placed in accordance with the Wastewater Management Division Standard Detail drawings and in conformance with this specification.

#### 4. Frame and Cover

Unless otherwise noted on the drawings, frame and covers for manholes and special structures shall be the current Denver Standard pattern, manufactured by an approved foundry. Castings shall, at the minimum, meet the requirements of ASTM A48, Class 35B, and other Agency requirements as a condition of approval. Horizontal bearing surfaces of all rings and covers shall be machined to eliminate any rocking action or non-uniform bearing. Castings shall not be dipped or painted prior to field inspection and acceptance. Refer to the Wastewater Management Division Standard Detail Drawings for additional requirements.

## 5. Manhole Steps

Manhole steps shall be required for all new manholes greater than 4 feet in depth, from the rim to the top of the bench, unless otherwise specified within the Contract Documents.

## 6. Flexible Plastic Joint Sealing Compound

All joints in the manhole barrel, cone and/or flat top sections including the joint between the cast-in-place base and the bottom barrel section, shall be sealed with an approved preformed, flexible plastic gasket conforming to the following requirements:

- a. The flexible plastic gasket shall be in conformance with ASTM C-990-91, AASHTO M198-B, and ASTM C-990, latest versions.
- b. The plastic sealing compound shall be packaged in extruded pre-formed rope-like shapes of proper size to completely fill the joint when completely compressed, as per the pipe manufacturer's recommendations. The material shall be protected by a suitable, removable two-piece wrapper that may be removed as the compound is applied to the joint surface without disturbing the other wrapper, which remains attached to the compound for protection. The sealing compound shall be impermeable to water, have high immediate bonding strength to the concrete surface and shall maintain permanent plasticity, as well as resistance to water, acids, and alkalis inherent in sewer systems.
- c. All lifting holes shall be permanently and properly sealed with the plastic sealing compound or an approved concrete grout.

## 7. Adjustment

Grade rings shall be used to adjust and set final rim elevations, brick is not allowed. A 3-inch cast iron riser shall be used in conjunction with grade rings on all construction within streets. Cast iron shall conform to ASTM C62, Grade SW [AASHTO M114].

## 8. Mortar and Grout

Mortar and grout used in the shaping of inverts, grade ring gaps, setting and anchoring cast iron street fabrications, etc., shall consist of one part Type II Portland Cement and two parts of fine, clean sand. Only sufficient water shall be added to provide a stiff, workable cement mixture for proper troweling. Hydrate lime or masonry cement shall not be used. Where relatively thin portions of grout are to be applied to the flow channel, top of bench, etc., and approved epoxy bonding coat shall be applied to the exposed concrete surfaces prior to grouting.

### 11.0.2.3 Bases and Inverts

Except as otherwise shown on the drawings, manhole bases shall be constructed of cast-in-place or precast concrete, as shown in the Wastewater Management Division Standard Detail Drawings, and as otherwise described in these Standard Construction Specifications. Inverts may be cast separately, but shall be constructed of cast-in-place concrete. All concrete used for these applications shall meet the requirements set forth in section 11.0.2.2 of these Standard Construction Specifications.

## 1. Sanitary Sewer Manholes

Sanitary Sewer manholes are normally designed and constructed such that inverts of the influent and effluent sewers are at the same relative elevation with sufficient drop to compensate for pressure head losses occurring in the manhole. Therefore except for special cases, the bench around the flow channel shall be constructed to the outside top of the largest pipe in the manhole. The top of the bench shall be poured with a slope towards the flow channel with an overall cross slope not exceeding  $\frac{1}{2}$  inch. Flow channels shall have smooth, rounded inverts shaped to match the lower half of the pipe. Proper shaping shall be accomplished by forming or shaping with a proper cement grout mixture. Changes in direction of flow through the manhole shall be made with a smooth continuously-curved channel utilizing the maximum radius possible. Changes in the size of channels, multiple flow channels, or changes in invert slopes, shall be made gradually and evenly, and shall be formed directly in the concrete.

- a. Outside Drops. Whenever specified on the Drawings, directed by the Construction Project Manager, or where the elevation difference between the incoming sewer inverts and the outgoing invert is 18 inches or greater, an outside drop shall be constructed. The diameter of the drop shall not be less than the diameter of the incoming sewer pipe to be dropped. A concrete encasement will be required around the drop pipe as shown and detailed within the Wastewater Management Division Standard Details, S-530.

Quantities and costs for the outside drop configuration shall be measured and paid for separately from the manhole unless otherwise specified.

## 2. Storm Sewer Manholes

Flow channels in storm sewer manholes shall be as shown in the Wastewater Management Division Standard Detail Drawings for the particular type of manhole base utilized. Except for special situations, and where specifically noted, outside manhole drops will not be required. All exposed channel edges and cut pipe edges shall be grouted smooth. The minimum thickness of the cast-in-place concrete at any point shall not be less than 6-inches. The construction of the manhole base and shaping of inverts, including all pipes within the dimensions of the manhole, will be considered to be incidental to the construction of the manhole and all costs shall be included in the unit price bid for the manhole structure.

### 11.0.2.4 Stub-Outs and Block-Outs

Block-outs are the preferred method of construction for future connections. These shall be constructed as specified within the Contract Documents.

Where stub-outs are specifically indicated on the drawings and where a specified pipe size for future connections is to be constructed, the pipe used for stubbing shall extend a nominal 2 feet beyond the outside of the manhole barrel, unless otherwise noted, and shall terminate with a bell end [or spigot end if applicable]. The pipe end shall be sealed with an approved, pre-fabricated plug or cap conforming to the joint detail of the pipe supplied. For



pipe greater than or equal to 30-inches in diameter, a full section of pipe shall be installed as the manhole stub. Shop drawings shall be submitted for approval.

The use of brick or concrete fill as a means of plugging will only be permitted on sewers that are to be abandoned. Unless otherwise stated in the contract documents, stub-outs and plugs or caps will be considered to be incidental to the construction of the associated manholes, and all costs incurred shall be included in the unit price bid for the manhole structure.

#### **11.0.2.5 Flexible Booted Connections**

Flexible watertight rubber boots for the jointing of any sewer pipe to any precast manhole base, barrel section, inlet box, or vault shall conform to the Specifications contained herein and to the Wastewater Management Division Standard Detail Drawings. Flexible connectors shall meet the requirements of ASTM C923.

- A separate submittal package specific to each pipe size and unique project scenario shall be required for approval by the Construction Project Manager prior to product procurement by the Contractor. At a minimum, this submittal shall include jacking force calculations (see 7.1.4), joint design, and a special pipe detail for each situation.

### **11.0.3 Structures**

#### **11.0.3.1 Concrete**

All structural concrete shall be CDOT Class D, with the revisions noted within this section.

#### **11.0.3.2 Reinforcement**

All structures shall be reinforced as shown on the Drawings or within the Wastewater Management Division Standard Details. All reinforcing steel shall be ASTM A-615, Grade 60 with deformed bars.

### **11.0.4 Concrete Flatwork**

#### **11.0.4.1 Concrete**

All flatwork shall be CDOT Class D, unless otherwise approved by the Project Engineer.

#### **11.0.4.2 Reinforcement**

All required reinforcement shall be in accordance with the Contract Documents.

### **11.0.5 Storm Inlets**

The work under this subsection shall consist of furnishing all materials and constructing concrete catch basins, including excavation, concrete removal and backfill. Work shall be done at the locations designated on the project plans and in accordance with the Wastewater Management Division Standard Detail Drawings and other requirements of the Contract Documents. All inlet structures and related components shall be designed for AASHTO HS20 loading conditions.

#### **11.0.5.1 Concrete**

Concrete shall be Class D, with a minimum 28-day strength of 4500 psi. Cement used in concrete shall conform to ASTM Designation C-150 Type II cement. All concrete used for these applications shall be meet the requirements set forth within these Standard Construction Specifications.

#### **11.0.5.2 Masonry Mortar**

Masonry mortar (grout) shall be composed by volume of one part Portland cement, two parts fine aggregate, one fifth part hydrated lime and sufficient water to provide a plastic mixture. Mortar in concrete fill shall obtain a 28 day strength of 2000 psi.

#### **11.0.5.3 Reinforcement**

All inlets shall be reinforced as shown on the Drawings or Wastewater Management Division Standard Details. All reinforcing steel shall be ASTM A-615, Grade 60 with deformed bars. The diameter of bend measured on the inside of the bar shall be 6 bar diameters. All reinforcing steel shall be 2" clear minimum from formed surfaces and 3" clear against earth unless otherwise noted. Splicing of reinforcing steel shall be permitted only where detailed on the Drawings.

#### **11.0.5.4 Connectors**

Connectors for single inlets shall be 15" diameter (min.) with desired slope of 1 percent, for double inlets connectors shall be 18" diameter with desired slope of 1.8 percent and for triple inlets connectors shall be 21" with a desired slope of 1.8 percent. All connections to main line storm sewers shall be cored and collared in accordance with the Wastewater Management Division Standard Detail Drawings. Saw cutting and/or jack hammering will not be permitted.

#### **11.0.5.5 Castings (No. 16 Inlets)**

Frame shall be Denver Standard Pattern and grate where required shall be No. 16 Grate (Wastewater Management Division Standard Detail-S-716). All castings shall conform to ASTM A-48 (Class 35b) with a minimum tensile strength of 35 ksi. Castings shall not be dipped or painted prior to field inspection; once castings are approved by the Division for project usage, they shall be coated with an approved material. All castings shall be heavy duty and capable of withstanding AASHTO H-20 loadings. Horizontal bearing surfaces of all frames and grates shall be machined to eliminate any rocking action or non-uniform bearing.

#### **11.0.5.6 Steps**

Manhole steps shall be required for all new inlets greater than 4' in depth, , unless otherwise specified within the Contract Documents. Single Type 16 inlets are exempt from this requirement.

#### **11.0.5.7 Construction Requirements**

All storm inlets shall be constructed of cast-in-place concrete, unless specifically approved for precast construction by the City. Precast inlets shall meet the requirements of 11.0.1 (revised 602.08 Special Design)

### **1. Bedding and Backfill**

All catch basins/inlets shall be cast in place. Subgrade shall be Class B Bedding compacted to 90% maximum dry density (AASHTO designation T-180). Backfill shall be hand tamped in 6" lifts, Backfill Method B.

### **2. Inlet Depths**

Desired depths for single inlets shall be 3.5 feet (flow line to floor), for double inlets depth shall be 4 feet and for triple inlets depth shall be 4.5 feet. Inlets are designed to allow for 6 foot depth maximum; for depths greater than 6 feet, shop drawings and design analysis shall be submitted for approval by the Construction Project Manager.

### **3. Forming**

Inlets shall be formed both inside and out; casting of sidewalls against earth walls or other structures is not permitted. No formwork shall remain inside structure when complete.

## **11.0.6 Backfill Requirements**

The following outlines backfill requirements around manholes, structures, inlets, utilities and appurtenances. Structures shall include but not be limited to: type B manholes, type P manholes, box culvert and special structures noted within the Contract Documents. All structures shall be constructed in accordance with the most recent addition of the Wastewater Management Division Standard Detail drawings, and/or in conjunction with special details provided within the Contract Documents.

Method B backfilling, as described within these Standard Construction Specifications, is required around manholes, structures, inlets, utilities and appurtenances, unless otherwise specified or directed by the Construction Project Manager. The following backfilling constraints and requirements shall apply for all such facilities:

#### **1. Cast-in-place: Inlets ( $\leq 6'$ deep), Manhole Bases and Structure Bases**

May be backfilled and compacted around, once the concrete has achieved 80% of the required 28-day compressive strength indicated in the Contract Documents.

For inlet depths larger than six (6) feet, from top of base slab to the top of wall at flow line of the lip, shop drawings and a design analysis must be submitted to the Construction Project Manager for approval. These submittals shall address the backfilling constraints during and after inlet placement.

#### **2. Cast-in-place: Structure Walls**

Shall not be backfilled or compacted against until the deck (top) slab has been placed, the walls have attained 80% of the required 28-day compressive strength, and the deck (top) slab has attained 80% of its required 28-day compressive strength as indicated in the Contract Documents.

#### **3. Cast-in-place: Structure Decks or Top Slabs**

May only be backfilled and compacted over once the concrete has attained the required 28-day compressive strength indicated in the Contract Documents.

**4. Precast: Structures, Manhole Bases, Barrels, Cone Sections and Inlets**

All precast components may be backfilled and compacted against, if manufactured a minimum of 28-days prior to placement, or if concrete test results demonstrate that the required 28-day compressive strength indicated in the Contract Documents has been achieved.

Precast barrels and cone sections may only be placed on cast-in-place manhole bases after 80% of the required 28 day compressive strength indicated in the Contract Documents has been attained.

Alterations and special allowances to these criteria may be granted at the discretion of the Construction Project Manager on a case by case basis.

**End of Specification**



CITY AND COUNTY OF DENVER  
ENGINEERING DIVISION

## Wastewater Capital Projects Management Standard Construction Specification

---

### **12.0 Riprap, Boulders and Slope/Channel Protection**

#### **12.1 General**

This work consists of furnishing all labor, equipment and materials necessary to place riprap, soil riprap, grouted riprap, and erosion resistant materials where detailed on the Plans or as directed by the Construction Project Manager. The work includes water control, excavation and backfill, grading, sub-grade preparation, materials and installation of bedding, rock, riprap, boulders and grout as indicated herein and in the Contract Documents.

#### **12.2 Submittals and Testing**

In accordance with the Special Conditions submit documentation indicating source of stone and certifying materials for all types of rock will meet the requirements of this section. Include test results for specific gravity, abrasion, gradation and freeze thaw on samples of rock to be supplied on this project. Submit design mix for grout. In advance of delivery of rock to the work site an inspection of the quarry shall be arranged by the Contractor and shall include the Contractor, Construction Project Manager, and Quarry Representative. The quarry will identify the rock source and procedures that will be used to stockpile, mix and grade the types of riprap and boulders specified. The Construction Project Manager, following receipt and review of current gradation test results, may waive the requirement for field gradation tests at his discretion. If gradation tests are determined to be necessary by the Construction Project Manager, the following procedures shall be used.

For each type of riprap specified a random sample will be selected by the Construction Project Manager. The objective is to obtain a sample as it would be handled for normal delivery to the work site. It will then be placed in an approved area at the quarry and sized and sorted to identify and weigh the individual pieces as directed by the Construction Project Manager. The Contractor and Quarry Representative shall apply all labor and equipment to sort and weigh the riprap. Submit weight data of individual pieces and summary gradation curve. The approved sample shall then be hauled to the work site and stockpiled for comparison of future riprap deliveries. If the riprap being delivered appears to be outside of the specified gradation, or does not resemble the same stockpiles, the Contractor shall make appropriate adjustments at the quarry to ensure riprap meets the requirement of the Specification.

Boulders shall be visually checked by the Contractor at the quarry or work site as required for size, elongation, cracks, deterioration and other defects visible on the entire surface of the stone. If cracks are observed, the Contractor shall notify the Construction Project Manager to re-inspect and retest the rock. Stone with cracks or defects that are detrimental to a long lasting product shall not be shipped to the work site.

### **12.3 Riprap and Boulders**

Only quarry rock that is sound and durable against disintegration under conditions to be met in handling and placing, and is hard and tenacious and otherwise of suitable quality to ensure permanency in the specified kind of work, shall be used.

All rock shall be angular, each piece having its greatest dimensions greater than 3 times its least dimensions and shall conform to the following requirements and testing standards:

1. The riprap designation and total thickness of riprap shall be as shown in the contract documents. The maximum stone size shall not be larger than the thickness of the riprap.
2. The specific gravity of the riprap shall be two and one-half (2.5) or greater.
3. Neither width nor thickness of a single stone of riprap shall be less than one-third ( $\frac{1}{3}$ ) of its length.
4. Broken concrete or asphalt pavement shall not be acceptable for use in any portion of the Project.
5. Rounded riprap (river rock) is not acceptable unless specifically designated in the Contract Documents.
6. The color of the riprap shall be gray with gray/blue hues or other acceptable colors approved by Construction Project Manager prior to delivery to the Project site. Color shall be consistent on the entire Project and shall match the color of rock to be used for all other portions of the Project Scope.
7. Minimum density for acceptable riprap shall be one hundred sixty five (165) pounds per cubic foot. The specific gravity shall be according to the bulk-saturated, surface-dry basis, AASHTO T85.
8. The riprap shall have a percentage loss of not more than forty percent (40%) after five hundred (500) revolutions when tested in the Los Angeles machine in accordance with AASHTO Test T96.
9. The riprap shall have a percentage loss of not more than ten percent (10%) after five (5) cycles when tested in accordance with AASHTO Test T104 for ledge rock using sodium sulfate.
10. The riprap shall have a percentage loss of not more than ten percent (10%) after twelve (12) cycles of freezing and thawing when tested in accordance with AASHTO Test T103 for ledge rock, procedure A.

11. Rock shall be free of calcite intrusions.
12. Each load of riprap shall be reasonably well graded from the smallest to the largest size specified. Stones smaller than the two-to-ten percent (2-10%) size will not be permitted in an amount exceeding ten percent (10%) by weight of each load. Control of gradation shall be by visual inspection. However in the event Construction Project Manager determines the riprap to be unacceptable, the Construction Project Manager shall pick two (2) random truckloads to be dumped and checked for gradation. Mechanical equipment and labor needed to assist in checking gradation shall be provided by Contractor at no additional cost.

### **12.3.1 Types, Sizes and Classifications**

The types, size, or classification of riprap to be placed will be noted on the Plans. Unless otherwise specified in the Plans or the Contract Documents riprap placed in accordance with the requirements for "dumped riprap" will be considered satisfactory. All riprap shall be placed on a prepared slope on a prepared filter media consisting of either a heavy duty plastic filter cloth or a free draining granular bedding media as described in the materials section of this specification. If the existing soils conditions meet the requirements for filter media the filter media will not be required.

Riprap used shall be the type designated within the contract documents and shall conform to **the table on the following page:**

Riprap Designation	% Smaller Than Given Size By Weight	Intermediate Rock Dimension (inches)	d <sub>50</sub> * (inches)
Type VL	70 - 100	12	6
	50 - 70	9	
	35 - 50	6	
	2 - 10	2	
Type L	70 - 100	15	9
	50 - 70	12	
	35 - 50	9	
	2 - 10	3	
Type M	70 - 100	21	12
	50 - 70	18	
	35 - 50	12	
	2 - 10	4	
Type H	70 - 100	30	18
	50 - 70	24	
	35 - 50	18	
	2 - 10	6	
Type VH	70 - 100	41	24
	50 - 70	33	
	35 - 50	24	
	2 - 10	9	

\* d<sub>50</sub> = Mean Particle Size



### **12.3.1.1 Dumped Riprap**

This type of riprap shall consist of angular or fractured rock dumped in place on a prepared slope and filter media to form a well graded mass with a minimum of voids. Asphalt, broken concrete and other materials not classified as rock will not be allowed for use as riprap.

### **12.3.1.2 Soil Riprap**

The soil material shall be native or topsoil and mixed with sixty five percent (65%) riprap and thirty five percent (35%) soil by volume. Soil riprap shall consist of a uniform mixture of soil and riprap without voids. Bedding material is not required for soil riprap. This type of riprap shall consist of angular or fractured rock mixed with 35% soil by volume dumped in place on a prepared slope to form a uniform mixture of soil and riprap without voids per Section 12.2.1C.

### **12.3.1.3 Grouted Riprap**

This type of riprap shall consist of rock with all parts of the interstices filled with Portland cement mortar. The finished product shall be aesthetically pleasing resembling hand placed stone or fireplace rockwork. Colored concrete grout may be specified as defined elsewhere within these Standard Construction Specifications.

### **12.3.1.4 Feature Boulders**

Feature Boulders shall consist of the same material as riprap, differing only by size. Feature Boulders shall have a minimum dimension of four (4) feet, or as shown on the Plans.

### **12.3.1.5 Boulders**

Boulders shall consist of the same material as riprap, differing only by size. Boulders shall have a minimum dimension of two (2) feet, or as shown on the Plans.

## **12.3.2 Bedding**

The granular bedding designation and total thickness of bedding shall be as shown in the Contract Documents. Granular bedding shall meet the same requirements for specific gravity, absorption, abrasion, sodium sulfate soundness, and freeze-thaw durability as required for riprap and as follows:

1. Broken concrete asphalt pavement or sledge, shall not be acceptable for use in any project. Rounded river rock is not acceptable unless specifically designated in the Contract Documents.
2. Shall conform to the quality requirements of AASHTO M197.
3. The requirements for the wear test in AASHTO T96 shall not apply.

4. Gradation for Granular Bedding:

<b>U.S. Standard</b>	<b>Percent by Weight Passing</b>	<b>Square Mesh Sieves</b>
<u>Sieve Size</u>	<u>Type I</u>	<u>Type II</u>
3 inch		90 - 100
1-½ inch		
¾ inch		20 - 90
⅝ inch	100	
No. 4	95 – 100	0 - 20
No. 16	45 - 80	
No. 50	10 - 30	
No. 100	2 - 10	
No. 200	0 - 2	0 - 3

## 12.4 Excavation

The excavations shall be finished to smooth and uniform surfaces conforming to the line and grade specified. Variation from the finished grade elevations specified shall not be more than 1.0 inch. Materials shall not be wasted without written permission of the Construction Project Manager. Excavation operations shall be conducted so material outside of the slope limits will not be disturbed. Prior to beginning grading operations, all necessary clearing and grubbing in that area shall have been performed. The top six (6) inches of material from all areas to be excavated shall be designated as topsoil and shall be removed and stockpiled in the designated location on the plans. Following removal of topsoil, in the designated excavation areas, the remaining material shall be removed and stockpiled separately for use as sub-grade material in the designated location on the plans. Unclassified excavation shall consist of the excavation of all materials of whatever character required for the work, obtained within the project limits, including surface boulders, masonry, organics, muck, and slag that are not removed under some other item. The work will also include hauling of unsuitable unclassified excavation materials off the site.

### 12.4.1 Unclassified Excavation

All excavation from six (6) inches below existing grade to the top of sub-grade for the associated boulders and/or riprap shall be designated as Unclassified Excavation.

Unless otherwise stipulated in the Contract Documents, no separate payment will be made for unclassified excavation and all costs incurred will be considered to be included within the unit price bid for the associated work.

#### **12.4.2 Overexcavation**

In locations where soil with unsuitable bearing characteristics are encountered, the Construction Project Manager may order that the unsuitable material be removed and be replaced with granular and/or rock backfill material to provide suitable bearing for the structure. At least eight (8) inches of acceptable material must be present below the proposed riprap, soil riprap, grouted riprap or boulders within two (2) feet of existing grade.

The overexcavation will be paid for in accordance with the bid items included within the Contract Documents, regardless of soil classification. No measurement for payment will be made of any material removed or necessary to fill overexcavated areas: outside of the limits for structure excavation, outside of limits defined within the Contract Documents, beyond the limits required for structure excavation performed for the Contractor's convenience or, where excavations for footings, slabs, etc., are made below the required elevations without specific authorization from the Construction Project Manager. In these situations, excess excavation and backfill shall be at the Contractor's expense and the areas shall be filled in a manner satisfactory to the Construction Project Manager.

#### **12.4.3 Removal of Water**

During construction, the Contractor shall provide and maintain adequate equipment to properly remove and dispose of all water entering the work area. In water bearing strata, well points, sub drains or any other method approved by the Construction Project Manager may be required to provide a dry trench.

The discharge from any dewatering operations shall be conducted to natural drainage channels or other structures as approved by the Construction Project Manager and in accordance with applicable permits. Ground water shall not be discharged into sanitary sewers.

Excavation work areas shall be kept free from water during excavation, fine grading, pipe laying and grouting. Dewatering, sufficient to provide a completely dry work area, shall be maintained during all excavation, construction and grouting operations. The Contractor shall be responsible for damage of any nature resulting from the dewatering operations.

Unless provided for in the Contract Documents, dewatering shall be considered as incidental to construction and all costs incurred will be considered to be included in the unit price bid for the construction of each section of sewer line, associated structures, laterals and appurtenances.

## **12.5 Backfill**

Backfill around riprap or boulder structures shall be performed in accordance with these Standard Construction Specifications. Backfill shall be placed only after walls or other constructed items have been inspected and the approval of the Construction Project Manager to commence backfilling has been obtained. Backfilling against riprap or boulder structures is allowed only after the concrete has properly cured for not less than seven days, or until other testing procedures (concrete test cylinders) indicate that the concrete has attained sufficient strength so as not to be damaged by the backfilling operation.

## **12.6 Topsoil**

Top soil material shall be taken from the topsoil stockpile and placed to a minimum depth of six (6) inches to the limits shown on the plans. Additional topsoil material, if necessary, shall be obtained from the sub-grade stockpile as approved by the Construction Project Manager. The topsoil shall be placed uniformly and compacted to a minimum of 85% Standard Proctor density ASHTO T-99. The intent is to provide a suitable medium for revegetation activities.

## **12.7 Unsuitable Materials**

Materials encountered during construction that are deemed by the Construction Project Manager to be unsatisfactory as structure sub-grade shall be removed to a maximum depth as approved by the Construction Project Manager, and replaced with stabilization material including, rock, or other materials approved by the Construction Project Manager. The source of stabilization material shall be approved by the Construction Project Manager prior to placement. Excavated muck shall be removed and hauled off the site.

## **12.8 Construction Requirements**

Channel slopes, bottoms, or other areas that are to be protected with riprap, soil riprap, or boulders shall be free of brush, trees, stumps, and other objectionable material and be graded to a smooth compacted surface. Contractor shall excavate areas to receive riprap or boulders to the sub-grade for granular bedding or for soil riprap to the specified depth (bedding material is not required for soil riprap). The sub-grade materials shall be stable. If unsuitable materials are encountered, they shall be removed and replaced in accordance with these Standard Construction Specifications for sub-grade that has been excavated in undisturbed soil. Additional compaction shall not be required unless specified by Construction Project Manager. When sub-grade is built up with embankment material it shall be compacted to ninety five percent (95%) optimum density (ASTM D698). After an acceptable sub-grade is established, the soil riprap or bedding shall be immediately placed and leveled to the specified elevation. Immediately following the placement of the bedding material, the riprap shall be placed. If bedding material is disturbed for any reason, it shall be replaced and graded at Contractor's expense. In-place bedding materials shall not be contaminated with soils, debris or vegetation before the riprap is placed. If contaminated, the bedding material shall be removed and replaced at Contractor's expense.

### **12.8.1 Placement**

For the purposes of the following, boulders, riprap and rock are used interchangeably.

---

When riprap is placed on slopes, placement shall commence at the bottom of the slopes working up the slope. Place the riprap in a stepped fashion with the bottom of the uphill riprap below the top of the downhill riprap by one half ( $\frac{1}{2}$ ) of the height of the riprap minimum.

The entire mass of riprap shall be placed on either channel slopes or bottoms so as to be in conformance with the required gradation mixtures and to lines, grades, and thickness shown on the plan set. Riprap shall be placed to its full course thickness at one operation and in such a manner as to avoid displacing the underlying bedding material. Placing of riprap in layers, or by dumping into chutes, or by similar methods shall not be permitted.

All material going into riprap protection for channel slopes or bottoms shall be so placed and distributed that there shall be no large accumulations of either the larger or smaller sizes of stone. Some hand placement may be required to achieve this distribution.

It is the intent of these Standard Construction Specifications to produce a fairly compact riprap protection in which all sizes of material are placed in their proper proportions. Unless otherwise authorized by Construction Project Manager, the riprap protection shall be placed in conjunction with the construction of embankments or channel bottoms with only sufficient delay in construction of the riprap protection, as may be necessary, to allow for proper construction of the portion of the embankment and channel bottom which is to be protected. Contractor shall maintain the riprap protection until accepted. Any material displaced for any reason shall be replaced to the lines and grades shown in the Contract Documents at no additional cost to City and County of Denver. If the bedding materials are removed or disturbed, such material shall be replaced prior to replacing the displaced riprap.

The basic procedure shall result in larger materials flush to the top surface with faces and shapes arranged to minimize voids, and smaller material below and between larger materials. Surface grades shall be a plane or as indicated, but projections above or depressions under the finished design grade more than ten percent (10%) of the rock layer thickness shall not be allowed. Smaller rock shall be securely locked between the larger stone. It is essential that the material between the larger stones not be loose or easily displaced by flow or by vandalism. The stone shall be consolidated by the bucket of the backhoe or other means that will cause interlocking of the material. All rock is to be placed in a dewatered condition beginning at the toe of the slope or other lowest point.

Riprap shall be rejected, which is either delivered to the job site or placed, that does not conform to this section. Rejected riprap shall be removed from the Project site by the Contractor at his/her expense.

Following acceptable placement of granular bedding, riprap placement shall commence using one of the following methods:

#### **Machine Placed Riprap**

Riprap shall be placed using appropriate construction equipment on the prepared slope or channel bottom areas in a manner which will produce a reasonably well-graded mass of stone with the minimum practicable percentage of voids. Riprap shall be machine placed, unless otherwise stipulated in the Contract Documents.

### **Hand Placed Riprap**

Hand placed riprap shall be performed during machine placement of riprap and shall conform to all the requirements outlined above. Hand placed riprap shall also be required when the depth of riprap is less than two (2) times the nominal stone size, or when required by the Contract Documents.

After the riprap has been placed, hand placing or rearranging of individual stones by mechanical equipment shall be required to the extent necessary to secure a flat uniform surface and the specified depth of riprap, to the lines and grades as shown in the Contract Documents.

#### **12.8.1.1 Types**

##### **Buried Riprap**

Where riprap is designated to be buried, place onsite excavated material that is free from trash and organic matter in riprap voids by washing and rodding. Prevent excessive washing of material into stream. When voids are filled and the surface accepted by the Construction Project Manager, place a nominal six (6) inches of soil over the area, or as designated in the Contract Documents. Fine grade, seed, and mulch per the Contract Documents.

##### **Soil Riprap**

Adjacent stockpiles of riprap and soil shall be created and mixing done at the stockpile location, not at the location where soil riprap is to be placed. Mix thirty five percent (35%) soil by volume with stockpiled riprap, using additional moisture and control procedures that assure a homogenous mixture, where the soil fills the inherent voids in the riprap without displacing riprap.

Place a first layer of smaller soil riprap of approximate  $d_{50}$  thickness. Then place the top layer with surface rocks that are largely  $d_{50}$  or greater, filling voids as necessary with smaller planted riprap. Create a smooth plane as described in Paragraph A. The mixture shall be consolidated by large vibratory equipment or backhoe bucket to create a tight, dense interlocking mass. The soil shall be further wetted to encourage void filling with soil. Any large voids shall be filled with rock and small voids filled with soil. Excessively thick zones of soil prone to washing away shall not be created (e.g., no thicknesses greater than six (6) inches). For buried soil riprap, the top surface shall be covered with four (4) inches of topsoil such that no rock points are protruding. The final surface shall be thoroughly wetted for good compaction, smoothed and compacted by vibrating equipment; the surface shall then be hand raked to receive planting or seeding. With prior approval of Construction Project Manager, layering the riprap and soil instead of premixing may be allowed if the native soil is granular.

##### **Feature Boulders**

Feature Boulders serve an aesthetic function and as such shall be placed and rotated into final position as directed by the Construction Project Manager in order to achieve the desired result.

## Grouted Boulders

Grouted riprap and boulder lined channel edge shall be placed at the locations as shown in the Construction Documents and installed with the following requirements:

1. The sub-grade to receive each boulder shall be excavated and any unstable material shall be removed. Approved material shall be placed and compacted in a maximum of four-inch (4") lifts to ninety five percent (95%) of Maximum Standard Proctor Density (ASTM D698) to re-establish the sub-grade of each boulder. Unstable material shall be removed from the Project site and disposed of by Contractor. Removal and replacement of unstable material shall only be completed at the direction of Construction Project Manager and shall be paid for under Muck Excavation. Backfill behind boulders shall be compacted to ninety five percent (95%) Maximum Standard Proctor Density (ASTM D698). Care shall be taken during compaction to avoid disturbing and/or damaging the integrity of the boulder channel edge.

The top of all boulders shall be as indicated in the Construction Documents. Finished grades and sub-grades for boulders will be determined from the height of each boulder used.

2. The boulders shall be carefully picked and arranged so that adjacent rock surfaces match within two (2) inches in top elevation and two (2) inches along the vertical exposed face or channel side of rock. Boulders shall be placed such that adjacent boulders "touch" each other and voids do not exceed four (4) inches. It is the intent of construction to minimize voids and grout placed between boulders.
3. Smaller rocks shall be "chinked in" to fill all voids behind the boulders. Placement shall be approved by Construction Project Manager prior to grouting.
4. Prior to placing the grout, any type of debris, fines, smaller rock, or silt shall be removed from around or under the boulders.
5. Dewatering shall be implemented to guarantee that the grout will not be placed in water and for a period of twenty four (24) hours after the grout has been placed.
6. Keep boulders receiving grout wet at all times prior to receiving grout. The concrete grout shall be placed by injection methods by pumping under low pressure, through a two-inch (2") maximum diameter hose to ensure complete penetration of the grout into the void area as detailed in the Contract Documents. Grout will be placed up to eight (8) inches from the top of boulders, or as directed by the Construction Project Manager. The Operator shall be able to stop the flow and will place grout in the voids and not on the surface of the rocks.
7. Grout shall be troweled out and finished to minimize visibility. Clean and wash any spillage before the grout sets. The visual surfaces of boulders will be free

of grout to provide a clean, natural appearance. If washing does not clean off grout residue, Contractor shall wash off any grout residue with muriatic acid and water, using a brush to scrub off the residue. A "pencil" vibrator shall be used to make sure all voids are filled between the boulders. The intent is to fill all voids from the sub-grade level around the boulders to a depth as shown in the Contract Documents. The "pencil" vibrator may be used to smooth the appearance of the surface, but Contractor shall use a wood float to smooth and grade the grout around the boulders. The grout mix shall be stiffened and other measures taken to retain the grout between the boulders.

8. Contractor shall, if deemed necessary, support the boulders from falling over before and during the placement of rock, grout, backfill, and compaction work on either side of the boulder.
9. Grout shall receive cold weather protection and curing in accordance with the most recent version of CDOT Standard Specifications for Road and Bridge Construction (section 601.13) as applicable.

## **12.9 Grouted Rock Retaining Walls**

Grouted rock retaining walls shall be placed at locations as shown in the Contract Documents and installed with the following requirements:

1. The grouted rock walls shall be constructed to the dimensions in the locations shown in the Contract Documents. The walls shall be constructed with a one (1) horizontal to four (4) vertical batter on the front and back face, with a minimum width of one (1) foot at the top of the wall.
2. The stone of the wall shall be laid to form substantial masonry, presenting a neat, finished appearance. Headers shall hold the heart of the wall to the face. Headers shall occupy at least twenty percent (20%) of the area and they shall be evenly distributed. The length of stretchers shall not exceed three (3) times their rise. Face stones shall be laid to break joint. Rock shall be hand graded so that only the larger stones are used in the face. Face stones shall be laid to break joint so that each rock laid rests on two beneath it. Spalls and pinners will not be allowed in the face and shall be used in the backing only where necessary.
3. All face stones shall be pitched to a string line on straight walls or laid to batter stakes for curved walls. The batter shall be consistent with respect to all parts of the wall and shall meet the minimum requirements set forth in the detail. The degree of roughness on the exposed face shall be measured with a six-foot (6') straightedge supported between adjacent projections and stone face. Variations in excess of 3 inches, measured from the straight edge to the extreme depression in the stone, will not be permitted. Rear faces shall present approximately plane surfaces and shall in general conform to the detail.
4. Grout shall be placed to fill all voids between the rocks throughout the walls. Any "loose" rocks shall be re-grouted by machine or hand methods. Grout shall



be recessed approximately two (2) inches from the face of the wall in order to give a "dry stacked" appearance.

5. Prior to placing the grout, any type of debris, fines, smaller rock, or silt shall be removed from around the rocks.

Dewatering shall be implemented to guarantee that the grout will not be placed in water and the area will remain dewatered for a period of ten (10) hours after the grout has been placed.

The surface of the rocks receiving grout shall be wet at all times prior to receiving grout.

6. Clean and wash any spillage before the grout sets on the outside face and top of walls. The visual surfaces of the rocks will be free of grout to provide a clean natural appearance. If washing does not clean off grout residue, then Contractor shall wash off any grout residue with muriatic acid and water, using a brush to scrub off the residue.
7. Grout shall receive cold weather protection and curing in accordance with the CDOT Standard Specifications for Road and Bridge Construction (section 601.13) as applicable.

**End of Specification**



CITY AND COUNTY OF DENVER  
ENGINEERING DIVISION

## Wastewater Capital Projects Management Standard Construction Specification

---

### 13.0 Fencing

#### 13.1 Description

This item shall consist of furnishing and installing new fencing and/or removing and salvaging the existing fencing and restoring the same in conformance with the lines, grades and/or alignment shown on the Plans. Wherever the materials to be removed are not in good condition, as judged by the Construction Project Manager, or wherever the Contractor has damaged the materials during the process of removal, equal or better quality fencing materials than the existing will be furnished and installed by the Contractor. Relocated and/or new fencing will be chain link, heavy construction type. The fence heights shall be as noted on the Plans.

##### 13.1.1 Chain Link Fence

Where specified on the plans or directed by the Construction Project Manager, chain link fencing shall be constructed as detailed on the drawings and as specified herein.

##### 13.1.2 Security Fence

Where specified on the plans or directed by the Construction Project Manager, security fencing shall be constructed as detailed on the drawings and as specified herein. The fencing shall be topped with 3-strand barbed wire which will extend the overall height of the fence by one (1) foot.

##### 13.1.3 Shop Drawings and Data

Complete detail drawings and specifications for the fence, gates and accessories shall be submitted in accordance with the procedure set forth in the Special Contract Conditions.

##### 13.2.4 Removal of Existing Fencing

All ties and clamps shall be removed to free the fabric from posts, rails, braces, tension bars and the like. The fabric shall be removed and stored appropriately to be reused. All rails, braces, barbed wire, tension bars and the like shall be removed from posts to a sufficient degree that will allow the removal of the posts.

The post footings shall be excavated and the concrete shall be broken until the post is free. Posts higher than ten (10) feet may be cut in segments or left intact for relocation at the option of the Contractor and as approved by the Construction Project Manager.

## 13.3 Materials

Materials for all fencing shall conform to the standards of the existing fence or to the minimum standards as outlined herein. All new steel or malleable iron parts and accessories shall be hot dip galvanized after fabrication.

### 13.3.1 Posts

All posts shall be steel pipe, ASTM A120, standard weight, Schedule 40. Post diameters shall be as follows.

#### a. Line Posts

- (1) Up to ten (10) foot high fence inclusive, line posts shall be 2-1/2 inch O.D. pipe, 3.65 lbs. per ft.
- (2) Over ten (10) foot to eighteen (18) foot high fence inclusive, line posts shall be 3 inch O.D. pipe, 5.79 lbs. per ft.
- (3) Over eighteen (18) foot to thirty (30) foot high backstop fence inclusive, line posts shall be 4 inch O.D. pipe 9.1 lbs. per ft.

#### b. Terminal End. Corner and Pull Posts

- (1) Up to eighteen (18) foot high fence inclusive; terminal, end, corner and pull posts shall be 3 inch O.D. pipe, 5.79 lbs. pr ft.
- (2) Over eighteen (18) foot to thirty (30) foot high backstop fence inclusive; terminal, end, corner and pull posts shall be 4 inch O.D. pipe, 9.1 lbs. Per ft.

#### c. Gate Posts. Pipe, 9.1 lbs. per ft. and 4 inch O.D.

- (1) **Top Rail** shall be 1-5/8 inch O.D. pipe, 2.27 lbs.
- (2) **Post Tops** shall be pressed steel or malleable iron designed to prevent entry of moisture into tubular posts and/or for barbed wire installation.
- (3) **Stretcher Bars** shall be steel, 3/16 inch by 3/4 inch, or equivalent area.
- (4) **Fabric** shall be No.9 wire woven into a 2" mesh; galvanized AS~M A392, Class II.
- (5) **Fabric Ties** shall be No.7 aluminum wire or 12 gauge galvanized steel wire.
- (6) **Concrete Collars** around posts: f'c -2000 psi, 5 sack mix, with Type r or Type II cement conforming to ASTM C-150.

### 13.3.8 Gates

Materials for gates shall conform to the

- a. **Fabric** shall be the same as fence fabric.
- b. **Frames** shall be 2 inch O.D. pipe, 2.72 lbs. per ft.
- c. **Hinges** shall be heavy pattern with large bearing surfaces and shall not twist or turn under the action of the gate.

- d. **Latches** shall be forked type and shall be arranged for padlocking, with the padlock accessible from both sides of the gate.
- e. **Stops** shall consist of a roadway plate with anchor set in concrete and arranged to engage the plunger.

### **13.3.9 Security Fence**

Materials for security fencing shall conform to the contract specific specifications and the following special items.

- a. **Barbed Wire Support Arms** shall be galvanized steel and shall extend at an angle of approximately 45°, and shall be fitted with clips or other means for attaching three strands of barbed wire. The top wire shall be approximately twelve inches horizontally from the fence line and the other wires spaced uniformly between the top of the fence fabric and the outside strand. The barbed wire support arm shall be of sufficient strength to withstand a weight of 200 lbs. applied at the outside strand of barbed wire.
- b. **Barbed Wire** shall consist of two strands of 12-1/2 gage steel wire with 14 gag; 4 point barbs spaced not more than 5 inches apart. All wire shall be zinc coated with a minimum coating of .80 ounces per square foot of surface area on 12-1/2 gage wire and .60 ounces per square foot of surface area on 14 gage wire.

## **13.4 Installation or Replacement of Fence**

### **13.4.1 General Constructions**

The Contractor shall perform such clearing and grubbing as may be necessary to construct or replace the fence to the required grade and alignment as shown on the Plans. Where specified on the plans or ordered by the Construction Project Manager, a one (1) foot wide concrete mowing strip shall be provided for the entire length of the fence. The fence shall be located along the center line of the mowing strip.

At locations where breaks in a run of fencing are required, appropriate adjustments in fence alignment and/or post spacing shall be made to satisfy requirements of conditions encountered.

### **13.4.2 Posts**

Posts shall be held in proper position by secure bracing until such time as the concrete has set sufficiently to hold the posts. Materials shall not be installed on posts, or stress placed on guys nor bracing set in concrete until the concrete has developed enough strength to withstand the stress.

All line, terminal, corner and gate posts shall be of the size specified. Posts shall be of the proper length to accommodate full height of fabric as shown on the Plans and provide for footing to the depth required. All posts shall be set plumb and firmly in concrete footings with a maximum spacing of 10 feet between posts. Concrete footings shall be domed to shed water. All terminal, corner and gate posts shall be braced with horizontal braces and diagonal truss rods.

All posts shall have a post cap of heavy galvanized malleable iron or pressed steel.

The tops of all posts shall be set to the required grade and alignment.

### **13.4.3 Fabric**

Fabric shall be firmly attached to the posts and braces. All wire shall be stretched taut and be installed to the required spacing. The completed fence shall be plumb and in straight alignment, firmly wired to prevent sag or looseness.

The fabric shall be the full height as shown on the Plans. Fabric shall be attached to the inside of posts with the wires or fabric clips, spaced at one (1) foot intervals on all posts and six (6) ties to each horizontal rail. Top and bottom selvages shall be knuckled for residential chain link fences and security fences.

### **13.4.4 Top Rails, Braces, Fittings, Ties, Tension Wire, Tension Bars**

These items shall be the same lengths, dimensions and quantities as those of the existing fence or as shown on the Plans. The existing items shall be removed and replaced and where new items need to be purchased, the quality shall be equal to or better than the existing. The top rail shall extend through all line posts to form a continuous brace from end to end of each stretch of fence, be securely fastened at the end of each run, and have joints made with expansion sleeve couplings not less than 5 inches long.

### **13.4.5 Gates**

Gates shall be constructed at or relocated to locations shown on the plans. Any materials not up to standard shall be replaced with materials of equal or better quality than the existing. Gates shall be installed to swing horizontally in true vertical plane and shall be provided with offset hinges to permit 180 degree swing.

Gates shall be installed so that they cannot be removed without disassembly of the hardware. Hardware attachment bolts shall be preened so that removal will be difficult.

Gates shall have all necessary latches, straps, locking bars and locking devices. Fabric shall be tightly stretched and securely fastened to gate frame with the proper number of bands, clips or tie wires and stretch bars shall be installed one (1) inch shorter than the full height of the fabric. Gates shall be free from sag or twist. Joints between frame members shall be made by welding or by means of heavy fittings and shall be rigid and water tight.

If welding is employed, it shall conform to the requirements of the American Welding Society. All welds shall be ground smooth. When the spelter coating has been burned by welding, the surface of the welded connection shall be thoroughly cleaned by wire brushing and all traces of the welding flux and loose or cracked spelter removed. The cleaned areas shall then be painted with two coats of zinc oxide-zinc dust paint conforming to the requirements of Federal Specification MIL-P-15145, latest revisions. The paint shall be properly compounded in a suitable vehicle in the ratio of one part zinc oxide to four parts zinc dust, by weight.

A method to padlock all gates shall be provided. Each padlock shall be provided with two keys.

**End of Specification**

---



CITY AND COUNTY OF DENVER  
ENGINEERING DIVISION

## Wastewater Capital Projects Management Standard Construction Specification

---

### 14.0 Removal and Disposal of Construction Debris and Contaminated Materials

#### 14.0.1 General

The Contractor shall be required to transport all non-hazardous solid waste and construction debris to the Denver Arapahoe Disposal Site (DADS) landfill, in accordance with Executive Order 115. Only approved haul routes around DADS may be used (Contractor must contact landfill directly for these routes). Landfill fees, gate fees and applicable State surcharges will be paid for by the City and County of Denver, Wastewater Capital Projects Management. The Contractor is responsible for any special handling charges imposed by Waste Management at DADS.

All costs associated with loading, hauling, and disposal of construction debris and/or contaminated soils at DADS shall be considered included within the unit price bid for construction of each section of sewer, the associated structures, laterals and appurtenances unless provided for elsewhere in the Contract Documents. The City and County of Denver, Wastewater Capital Projects Management will not provide hauling tickets nor cover the fees associated with disposal of recyclable materials at the DADS landfill. Recyclable materials shall include: concrete, asphalt, clean soil, and any other materials generated onsite with a monetary value. No payment will be made for the loading, hauling and/or processing of recyclable materials.

If the excavated soil appears to be re-usable, and the Contractor wishes to dispose of this material at a location other than DADS, then the Contractor shall obtain City Project Manager approval, obtain an environmental consultant approved by the City and County of Denver Department of Environmental Health at the Contractor's expense, and follow the minimum recommendations below or as required by the City Project Manager.

The Contractor shall analyze the following list of constituents as a means of determining whether the soil is suitable for re-use: Volatile Organic Constituents (VOCs), Semi-Volatile Organic Constituents (SVOCs), Pesticides, Herbicides, PCBs, Total Petroleum Hydrocarbons (TPH), 8 RCRA Metals, and Asbestos. Depending on the location of the project, additional constituents may be required for testing.

Soil samples shall be collected from the stockpiles every 500 cubic yards. Samples shall be collected by environmental professionals, evaluating the results with respect to

residential standards, and only re-using soil that meets residential standards. Depending on the location of the project, a more strict sampling/testing frequency may be required. If the soil is determined to be re-usable, the Contractor transferring the soil and the non-City entity which takes possession of the soil must sign an agreement, approved by the City Attorney's Office which will release the City from liability.

If the waste material cannot be accepted at DADS, the Department of Environmental Health has contact information regarding landfills which may accept the waste material. Landfill fees at these facilities will be paid for by the Contractor.

The work required for this section shall consist of exploratory investigation, testing, identification, removal and disposal of construction debris and contaminated materials associated with the construction of pipelines, box culverts, gulches, open channels, ponds and associated structures and appurtenances.

#### **14.0.2 Contaminants**

The contaminants required to be removed or treated may or may not be known at the time of award of the work. Contaminated soils may be encountered and have to be identified on the job site. Potentially and/or suspected contaminated sites of known and unknown origin may be listed at the end of the Contract Documents and are identified on the plans.

#### **14.0.3 Environmental Consultant**

The City and County of Denver, Wastewater Capital Projects Management will provide an Environmental Consultant to help identify, monitor and document and provide other assistance as required.

#### **14.0.4 Contaminated Soil Identification**

1. Remediation of soils with unknown contaminants will be performed by the Contractor as described herein or as directed by the Construction Project Manager with recommendations by the Environmental Consultant. Materials visibly contaminated or having field instrument (e.g. PID, FID, OVA, etc.) readings above established action levels will be excavated, or otherwise loaded for transport to an approved disposal facility or to a temporary storage area designated by the Construction Project Manager. Appropriate safeguards will be utilized to prevent or limit exposures to stored materials.
2. The stored material will be tested at the contractor's expense for contaminants. As dictated by the proposed disposal facility the parameters to be tested for will be based on the historical use of the area and the requirements of the facility used for disposal. The material will not be stored for more than 90 days.
3. Material identified as hazardous or non-hazardous will be disposed of in a manner consistent with current established federal, state and local regulations for waste material. A hazardous waste contractor shall be required for handling of hazardous material.

4. Materials with contaminants below action levels may be used for fill on-site or transported off-site. Materials with contaminants not specifically regulated will be disposed of as directed by the Construction Project Manager.
5. The owner of any contaminated material will be the City and County of Denver, for the purposes of permits and disposal only.

#### **14.0.5 Submittals**

The Contractor will submit the following information for approval prior to beginning work or as otherwise specified:

1. **Health and Safety Plan** meeting OSHA requirements of CFR 1910.120. The Health and Safety Plan for remediation work shall address the protection of health, safety and response to contingencies which could occur during remediation. It shall describe known and potential hazards related to remediation work activities. It shall include descriptions of construction and decontamination procedures for personnel and equipment. The plan will only be implemented if contaminated materials are encountered.

The contractor shall provide a project Health and Safety Officer. The project Health and Safety Officer shall be qualified by certification or training in the area of Industrial Hygiene or Hazardous Waste Health and Safety. The officer will have the authority and knowledge to design and implement a site-specific Health and Safety Plan and Hazardous Communication Program and to verify compliance with applicable safety and health requirements.

All persons working in and entering the areas designated by the Health and Safety Officer to be hazardous due to the presence or potential of contacting hazardous substances shall have previously received training according to the requirements in the Hazardous Waste Operation Regulations (OSHA 1910.120).

General site workers involved in construction activities in the designated areas shall receive 40 hours minimum training in the health and safety of hazardous waste; site workers and workers who are on-site occasionally to perform a single specified task shall receive 24 hours minimum of training. Personnel overseeing the health and safety of other workers shall receive an additional eight hours of supervisor training in that capacity. Documents certifying that the training requirements have been met and that all personnel are current on their refresher training shall be present at the project office or trailer or otherwise be made available to the project Health and Safety Officer and/or the Construction Project Manager.

In addition to the personnel working in the designated hazardous waste sites, all personnel working on this construction project shall be involved in the communication and understanding of potential hazards through a Hazardous Communication Program in accordance with the provisions of OSHA regulation 29 CFR 1910.12. This program shall include all elements of the regulations including training of personnel, compilation of Material Safety Data Sheets (MSDS), labeling, and placarding of hazardous chemicals, hazard identification of the construction area and monitoring of all activities to determine if new hazards are posed to the employees.



Reduced levels of training are to be identified for persons performing short duration or non-intrusive activities in areas in which the concentrations of or the potential for exposures to hazardous chemicals are reduced or shown to be minimal in the designated areas.

The training of employees in the non-designated areas are covered in the Hazard Communication Program for this phase of construction activities. This training shall include the following elements:

1. Methods of detecting hazardous chemicals.
2. Physical and health hazards of chemicals in the area.
3. Personal protective measures that are implemented to protect the employees.
4. Details of the Hazardous Communication Program such as emergency response procedures and location of the Material Safety Data Sheet.

## 2. Material Management Plan

**A. Sampling and Analysis Plan (SAP)** which describes methods of sampling, testing and analysis to obtain additional data on chemical constituents of the various materials. The Environmental Consultant will prepare this plan which shall be reviewed by all parties prior to the commencement of this aspect of construction. The purpose of the SAP will be to provide a basis for classifying a material as hazardous or non-hazardous and to provide confirmation and documentation of completed remediation work as it relates to project construction.

**B. Product Data:** Submit the following as part of a Pre-Construction Submittal Package.

1. Material list for items proposed to be provided under this section.
2. Certificates signed by the materials producer and the subcontractor stating that all material, meet or exceed the specified requirements.
3. **Materials Samples:** Submit adequate and representative samples of the backfill material to the Testing Laboratory for pre-construction tests.
4. **Test Reports:** Submit at least one week prior to beginning of the work of this section the test reports for the pre-construction testing performed by the Testing Laboratory.
5. **Disposal Profile Sampling:** If contaminated soil is known or believed to exist in the project alignment, the contractor shall be responsible for waste classification, profiling and manifesting. This shall be done in advance of the construction phase.

The material management plan is a dynamic document. It shall be the contractor's responsibility to coordinate revisions as necessary based upon changing site conditions.

## **14.0.6 Materials**

### **14.0.6.1 Backfill Materials**

Materials generated on-site or if imported shall be predominantly granular non-expansive soil free from roots and other unsuitable material meeting the requirements of Section 5.0 of these Standard Construction Specifications. The Contractor shall try to generate all backfill materials on-site. Imported fill materials will only be allowed in cases where sufficient quantities of suitable backfill material cannot be generated on-site.

### **14.0.6.2 Backfill of Excavated Areas**

Excavated areas outside the vertical limits of construction will be backfilled and regraded using uncontaminated soils. Compaction requirements are described in Section 5.0. The fill materials will be from on-site stockpiles as described above. The surface will be regraded to match natural contours and drainage patterns and the areas to be reseeded or otherwise restored to match existing conditions prior to the contaminated material excavation.

## **14.0.7 Execution**

### **14.0.7.1 Removal**

1. Contaminated materials will be removed to a depth of 3 feet below construction within the horizontal limits of construction at the direction of the Construction Project Manager. If the contamination extends less than three (3) feet, a minimum thickness of three (3) inches of soils below the contaminated materials will be removed, loaded, transported, and disposed of.
2. Upon completion of initial contaminated material removal, the excavated area will be inspected by the Construction Project Manager and or the Environmental Consultant and additional materials will be removed as deemed necessary based on visual observations, instrument readings, and the results of initial and confirmatory laboratory testing.

### **14.0.7.2 Disposal**

The contaminated soils requiring disposal will be transported to a land fill approved to accept the waste. The landfill will be approved by the Construction Project Manager prior to transport and landfill fees will be paid for by the Contractor. A payment item is provided for this in the Bid Form and Submittal Package. The Denver Arapahoe Disposal Site (DADS) and the Conservation Services Inc. facilities are licensed to accept non-hazardous waste. Facilities in Utah and Texas are licensed to accept hazardous waste.

### **14.0.7.3 Confirmation Sampling**

1. Upon completion of the contaminated material removal in each area, a confirmation soil sample will be collected by the Environmental Consultant in accordance with a Sampling and Analysis Plan (SAP) and the samples shipped to an approved testing laboratory for analysis.

2. The SAP will be prepared by the Environmental Consultant prior to construction and should contain methods of sampling and analysis to confirm if a material is hazardous or non-hazardous and that remediation work has been completed. The sampling will either be from a discrete location or composited, if appropriate. Duplicate and blank samples will be collected for laboratory quality assurance at the frequency described in the SAP. All samples will be labeled and sealed and appropriate chain-of-custody and shipping procedures followed.

#### **14.0.7.4 Field Testing**

1. The Testing Laboratory as designated by the Environmental Consultant, will perform tests and report results as approved by City's Department of Environmental Health (DEH) and the City and County of Denver, Wastewater Capital Projects Management on soil samples obtained by the Construction Project Manager. The City's Department of Environmental Health may act as internal consultant to the City and County of Denver, Wastewater Capital Projects Management as needed.
2. Obtain the Construction Project Manager's approval of subgrade materials with respect to the City and County of Denver, Wastewater Capital Projects Management requirements before subsequent construction is performed.
3. Notify the City and County of Denver, Wastewater Capital Projects Management and the Environmental Consultant of conditions contrary to accepted requirements.
4. The Colorado Department of Hazardous Wastes Management Division (CDHWMD) is the state's agency for reviewing cleanup measures. Since the contaminants and their levels are unknown and the Colorado Department of Hazardous Wastes Management Division does not have specific regulations for cleanup of materials that may be found, they will only "suggest" or review cleanup measures. They will in some cases provide a letter suggesting that they concur with the levels selected but make no commitments regarding long-term liabilities. They will maintain a file on each project if the information is provided to them. The following cleanup levels will be used for the site, but may be modified by CDEVS or CDHWMD.
  - Petroleum Product – 100 ppm TPH, 20 ppm BTEX (RACI)
  - Metals (CERCLA, Ep-Tox or TCLP levels)
  - Volatile and semi-volatile organics – 10 ppm total
  - PCB's – 10 ppm (TSCA regulation)

Cleanup levels are determined on a case-by-case basis for contaminants not specifically regulated under Resource Conservation Recovery Act or Toxic Substances Control Act. The cleanup will be implemented using visual observation of stained areas and an established action level for PID readings in a headspace test of 50 ppm for petroleum contaminated soils and 10 ppm for organic contaminants. If either of these conditions are met, the material will be considered contaminated and stockpiled for sampling, analysis and appropriation of disposal or potential reuse.

5. Test Report: At least once a week prior to the work of this Section, submit test reports for the pre-construction testing performed by the Testing Laboratory.

**14.0.7.5 Protection of Storm and Sanitary Sewers**

1. Concrete Cut-off Walls as shown in figure 2 of the City and County of Denver, Wastewater Management Division, Standard Detail for Trenching and Bedding (S-301.1) shall be constructed upstream and downstream of the contaminated area to prevent migration of hazardous material from off-site areas.

**End of Specification**



CITY AND COUNTY OF DENVER  
ENGINEERING DIVISION

## Wastewater Capital Projects Management Standard Construction Specification

---

### 20.0 Grass Sodding

#### 20.0.1 General

This item shall consist of placing grass sodding and fertilizing in conformity with the lines, grades and cross sections shown on the plans, stakes established by the Construction Project Manager, and in accordance with these Standard Construction Specifications.

The equipment and methods described in these Standard Construction Specifications may be modified where it is established to the satisfaction of the Construction Project Manager that the resultant product is equivalent to that specified herein.

#### 20.0.2 Materials

##### 20.0.2.1 Sod

Sod shall be Kentucky bluegrass and shall be approved by the Parks and Recreation Department before placement. At least 99% of the plants in the sod shall be of the variety specified. The sod shall be materially free from weeds or undesirable plants and stones larger than 1 inch in diameter. Sod shall be nursery grown and shall be mowed to a height not to exceed 2 inches before lifting and shall be of a uniform thickness with not over 1-1/2 inches soil or less than 1 inch of soil.

Delivered sod shall not contain more than 5% broken rolls. Sod shall be laid within 24 hours from the time it is lifted from the field.

Sod that has become moldy, withered, or yellow from storage or white from drying will be rejected at the time of planting. Rejected sod will not be counted for payment.

##### 20.0.2.2 Fertilizers

The area to be sodded shall be fertilized as follows:

- a. Well rotted cow manure shall be roto-tilled into the topsoil prior to sod placement.
- b. In general commercial fertilizer consisting of 20% nitrogen, 20% available phosphoric acid and 10% water soluble potash is acceptable. Commercial fertilizers shall be applied after the sod is laid and shall be a complete formulation or organic base, granular and free flowing.

### **20.0.2.3 Topsoil**

Topsoil may be selected from the material excavated at the job site by the Construction Project Manager and placed where needed to provide a 4inch minimum friable, fertile loam root-moisture zone. During the excavation operation, the acceptable on-site topsoil shall be removed and stockpiled in the area. Upon completion of the construction, the topsoil shall be placed to the correct line and grade in all areas requiring sodding and seeding. Topsoil will not be required in areas of special slope protection noted on the plans, in paving areas or other structures.

In the event the topsoil available from project excavation is insufficient, in the judgement of the Construction Project Manager, the Contractor shall import suitable topsoil in conformance with the select material requirements in section 5.0 of these Standard Construction Specifications. Payment for on-site or imported topsoil shall be as noted in the Measurement and Payment Section of these Standard Construction Specifications.

### **20.0.3 Construction**

#### **20.0.3.1 Time**

The Contractor shall place the sod between March 1 and November 1 of the Calendar year of construction. No sod shall be laid on frozen soil.

#### **20.0.3.2 Site Preparation**

The area to be sodded shall be cleared of all stones, roots, wood, weeds, and any other materials that may hinder proper grading, tilling, sodding, or subsequent maintenance, operations and shall be smooth before any sod is laid.

After the cow manure has been roto-tilled into the topsoil as specified in Subsection 20.3.4 below, fine grading shall be performed to insure reasonable grades and alignments per the grade stakes. Where no grade stakes are shown, areas shall be smooth and of continual grade between control points, such as walks and curbs. Areas of settlement shall be filled with topsoil and properly rolled to insure a firm bed true to the proposed grades. Areas of compacted soil, which are, in the judgment of the Construction Project Manager, too hard to serve as suitable subgrade, shall be scarified to a depth of six inches, and leveled and rolled.

After the fine grading operations have been completed, the entire area to be sodded shall be rolled with a 100 pound roller prior to sod placement.

#### **20.0.3.3 Sod Placement**

Sod shall be laid on a smooth, firm earth bed with staggered, tight joints. Care should be" exercised to avoid air voids along the joints and at end sections. Sections of sod that leave more than 1/2 inch joints opening shall be filled with a screened topsoil. Exposed edges shall be mounded with topsoil.

The sod shall be laid with staggered joints and shall run parallel to a 90-degree angle to the slope of the ground. If the slope is steeper than 2:1, the prepared sod bed shall be lightly and sufficiently watered prior to placement of the sod.

All sod laid slopes within 4 vertical feet of the flow line of open channels, gulches, etc. shall be held in place with 12 gauge u-shaped metal pins, minimum one inch in width, eight inches long driven flush with the top of the root zone. Prior to pinning, a 12" wide strip of 20 gauge 2" galvanized wire netting shall be placed at each corner and one in the center of each perpendicular edge (3 pins/1e" wide roll). Care shall be taken to insure that each pin will secure the wire netting to the sod. Pins shall be driven at intervals not greater than one foot from beginning to end of the roll and at each grade change in the slope. All sod shall be laid parallel to the center line of the channel.

#### **20.0.3.4 Fertilizer Placement**

Fertilizing accomplished in a two step operation as follows:

- a. Cow manure shall be spread over the surface of the ground of the areas to be covered at the minimum rate of one (1) cubic yard per thousand (1,000) square feet. The areas shall then be thoroughly roto-tilled to a depth of from a minimum of 4 inches to a maximum of 6 inches until no manure appears on the surface.
- b. Commercial Fertilizer shall be uniformly applied after the sod has been laid at the rate of 10-pounds per 1,000 square feet of coverage or as recommended by the fertilizer manufacturer. The method of application shall be subject to approval by the Construction Project Manager.

#### **20.0.3.5 Maintenance**

The Contractor shall be responsible for watering and mowing the sodded areas. Watering shall be performed periodically to insure a uniform root extension into the bed root--moisture zone. Mowing shall be performed to limit maximum grass height to three (3) inches and cut length of one and one-half (1-1/2) inches.

The maintenance period for sod shall continue for 90 days after notification in writing to the Construction Project Manager of the completion of sodding and the owner's initial approval. During this 90-day period the sod shall be kept growing and in place, and any movement or dead grass shall be replaced to the satisfaction of the Construction Project Manager. During this period, the sod's condition shall show normal to good progress so as to constitute an acceptable planting by the owner's representative. Watering shall be as required. If the planting within the reasonable care of the contractor does not show acceptable progress during this period, the areas affected shall be resodded, fertilized as required and growth progress repeated until results are obtained. This reworking shall be at the contractor's expense. If the planting is damaged or otherwise hindered due to causes beyond the contractor's control such as inclement weather or vandalism, the contractor shall rework the planting according to the item in the Measurement and Payment Section of these Standard Construction Specifications.

**End of Specification**



CITY AND COUNTY OF DENVER  
ENGINEERING DIVISION

## Wastewater Capital Projects Management Standard Construction Specification

---

### **21.0 Sprinkler Systems**

#### **21.0.1 General**

This section outlines the guidelines and requirements required to construct irrigation distribution lines and sprinkler systems required to complete construction per the Contract Documents.

The work shall include the installation of all line pipes, fittings, valves, and blow-offs, drain valves, controllers, electrical control and supply wires, all fittings and tapped couplings necessary for the connection of the lateral sprinkling system lines to the distribution system lines, etc. Also included will be the plugging and blocking of the cut ends of disconnected existing lines if any, connection to existing park water lines and/or city water mains, meter installation, and all fittings, valves, accessories, etc. necessary for these connections.

The pipe shall be installed to the prescribed lines and grades. All work required for the construction of the water lines, accessories and appurtenances thereto, including excavation, trenching, concrete work, pressure tests and miscellaneous items of work covered by the Plans and these Standard Construction Specifications shall be preformed.

#### **21.0.2 Proposed Substitutions**

Substitutions which will result in any changes in layout, installation, or coverage as designed and shown on the Plans and specified herein shall be accompanied by plans clearly showing the proposed installation including but not limited to materials, spacing, precipitation and scheduling. Such plans must be approved by the Construction Project Manager before work is to start.

#### **21.0.3 Qualifications of Installers**

The sprinkler system contractor shall have had considerable experience and demonstrated ability in the installation of sprinkler irrigation systems of this type. All work shall be installed by skilled persons proficient in the trades as required, in a neat, orderly and responsible manner with recognized standards of workmanship. At least one person shall be present at all times during the execution of this work who shall be thoroughly familiar with the type of materials being installed and the material manufacturers' recommended methods of installation and who shall direct work performed under this section.



#### **21.0.4 Staking**

All necessary staking for construction of the sprinkler system shall be done by the Contractor and checked by the City before excavation or installation is begun.

#### **21.0.5 Material**

Unless otherwise noted or approved, all materials shall be of the type as shown on the Plans and shall conform to the following specifications. Asbestos Cement Pipe shall not be used.

##### **21.0.5.1 Plastic Pipe**

###### **1. Rigid Plastic Pipe**

Shall be polyvinyl chloride (PVC) and shall conform to all requirements of Product Standard PS-22 or ASTM D-2241 or PVC 1120 (Type I), SDR-21 (Class 200). Pipe shall be National Sanitation Foundation (NSF) approved. Fittings shall be socket type PVC schedule 40 meeting all requirements of ASTM D-2466 and D-1784. Solvent used for joining pipe & fittings shall meet all requirements of ASTM D-2564 Rigid plastic pipe shall not be threaded except as noted below.

###### **2. Riser and Swing Joint Nipples**

Shall be PVC Schedule 80 threaded pipe and shall conform to all requirements of Product Standard PS-21 or ASTM D-1785. Fittings shall be threaded PVC Schedule 40 meeting all requirements of ASTM D-2466 and D-1784. Use Teflon tape on all threaded joints.

###### **3. Flexible Plastic Pipe**

Shall be polyethylene (PE), 80 psi rated and shall conform to all requirements of Product Standard PS-11 or ASTM D-2239 or PE-2306, SDR-15. Pipe shall be National Sanitation Foundation (NSF) approved. Fittings shall be insert type PVC meeting requirements of ASTM D-2609. Clamps shall be all stainless steel. Flexible plastic pipe shall not be used in any continuous pressure application.

###### **4. Markings**

All plastic pipe shall be continuously & permanently marked with the manufacturers name, pipe size, schedule number or SDR number, type of material and code number.

##### **21.0.5.2 Copper Pipe**

Copper pipe shall be type K copper, ASTM B-88. Fittings for copper pipe shall be wrought copper or cast bronze, 150 psi class. Joints shall be solder joints with 95-5 tin-antimony.

##### **21.0.5.3 Galvanized Steel Pipe**

Galvanized Steel Pipe shall be schedule 40 steel. Fittings shall be malleable galvanized iron, screwed pattern, 150 psi class. Galvanized pipe and fittings shall conform to ASTM A-120. Buried galvanized pipe except risers and casing shall be wrapped with heavy craft paper applied with hot asphalt. Wrap on fittings shall be glass cloth. Use Teflon tape on all threaded joints.

#### **21.0.5.4 Gate Valves**

Gate Valves shall be Class 125 (200 psi w.o.g.), shall open by turning to the left, shall have non-rising stems and shall have a clear waterway equal to the full nominal diameter of the valve. Gate valves (not buried) shall have solid wedges, union bonnets and shall comply with the following materials specifications: Handwheel Nut -Bronze ASTH B-16. Stem -Silicon Bronze ASTH B-371 Alloy A (Rod) or ASTH B-198 Alloy 13B; Packing -Teflon impregnated Asbestos; Packing Gland -Bronze ASTM B-62 or B16 ; Packing Nut, Stuffing Box, Bonnet, Union Nut, Body Wedge and Wedge Holder- Bronze ASTH B-62. These valves shall conform to Federal Specification WW-V-54C Class A, Type I. Buried gate valves 2 and larger shall conform to AWWA C-500, with double-disk wedges and O-ring seals.

#### **21.0.5.5 Valve Boxes**

Unless shown or noted otherwise, all underground valves not located in pits shall have cast iron boxes with flared bases. Valve boxes shall be 2 piece screw type.

#### **21.0.5.6 Angle Valves**

Angle Valves shall be rated at 150 psi or more, and shall open by turning to the left. Angle valves shall be designed for above or below ground installation with suitable cross wheel for operation with key. Valves shall have removable bonnet and stem assembly with packing gland nut and with replaceable seat washers. Angle valves shall be heavy pattern brass construction of the make and size shown on Plans or approved equal.

#### **21.0.5.7 Drain Valves**

Drain Valves shall be rated at 150 w.o.g. or more, shall open by turning to the left, and shall be the make and size as shown on Plans or approved equal. Unless shown or noted otherwise, drain valves shall be 3/4". If valve discharge is not downward, valves shall be provided with elbow for downward discharge.

#### **21.0.5.8 Quick Coupler Valves**

Quick Coupler Valves shall be 2 piece all brass construction of the make and size as shown on Plans or approved equal. Quick coupler keys and hose swivels shall be provided as shown on the Drawings.

#### **21.0.5.9 Manual Control Valves**

Manual Control Valves shall be either angle valves as described herein or Class 125 bronze globe valves meeting requirements of Federal Specification WW-V-51d Class A, Type I. They shall be of the make and size as shown on Plans or approved equal. Valves shall be key operated.

#### **21.0.5.10 Electric Control Valves**

Electric Control Valves shall be brass construction, normally closed, 24 volt AC electrically operated globe valves with slow-opening and slow-closing devices. They shall be of the make, model numbers, and size as shown on the Plans or approved equal.

#### **21.0.5.11 Valve Keys**

Two valve keys shall be provided for each type key operated valve installed.

#### **21.0.5.12 Unions**

Brass unions shall be provided where shown and/or required to allow removal of all control valves.

#### **21.0.5.13 Valve Pits**

Valve Pits shall be constructed as shown in the Valve Pit and Piping Detail. of these Standard Construction Specifications. Concrete shall conform to the requirements of Item 12 of the Standard Construction Specifications. Precast concrete rings or fiberglass pits and their respective covers may be submitted for approval by the Construction Project Manager.

#### **21.0.5.14 Automatic Controllers**

Automatic Controllers shall be 110 volt input, 24 volt AC valve output with both controller and control valves of the same manufacturer, designed to operate as a unit or as otherwise shown on the Plans. Controllers shall be capable of operating the number of valves shown on the Plan and shall be pedestal mounted unless shown otherwise on the Plans.

Controllers shall have a 2 hour clock, 14 day calendar wheel and individual station timers from 0 to 30 minutes. Manufacturer and model numbers shall be as shown on the Plans or approved equal. Unless located inside of a building, the controller shall be enclosed in an approved separate weatherproof, vandal resistant cabinet. A lock and 3 keys shall be furnished with each unit.

#### **21.0.5.15 Sprinkler Heads**

Sprinkler Heads of the type and size as shown on the Plans shall be furnished and installed as herein specified.

#### **21.0.5.16 Electric Control Wiring**

Electric Control Wiring shall be No.14 direct burial type U.F. cable or larger if required to operate the system as designed. Follow the recommendations of the controller manufacturer for sizing wire.

### **21.0.6 Installation**

#### **21.0.6.1 General**

Prior to any work described in this section, the Contractor shall carefully inspect the installed work of all other trades and verify that all such work is complete to the point where this installation may properly commence. The Contractor shall verify that the irrigation system can be installed in strict accordance with all pertinent Permits, codes and regulations, the original design, the referenced standards and the manufacturer recommendations. All necessary field measurements shall be made by the Contractor to ensure precise fit of items in accordance with the original design.

#### **21.0.6.2 Excavation**

Plastic pipe up to 2" in diameter may be direct bore if approved by the Construction Project Manager. All other lines shall be installed in open cut trenches. The width of the trench in which the pipe will be placed shall be sufficient to allow thorough tamping of suitable backfill material under, around and over the pipe. All excavated material shall be deposited at least two feet away from any trench side. Tunneling will be permitted only where pipe

must pass under any obstruction which cannot be removed. In backfilling the tunnel, the final density of the backfill must match that of the surrounding soil. It shall be acceptable to use a casing of suitable diameter which shall be installed first by tunneling or jacking, and the pipe shall then be laid through the casing, observing the same precautions as though it were installed in open trench. Any trench deeper than 6 feet shall be adequately shored and/or braced for safety considerations. If ground water is encountered during trench excavation above the elevation of the bottom of the pipe bell, such water shall be removed until the pipe has been installed and the trench backfilled. The Contractor shall take all necessary measures to insure that no ground water enters the pipe.

### **21.0.6.3 Piping and Control Wiring Depth**

All lines shall be installed with the following minimum depths of cover unless noted otherwise on the drawings:

- a. Pressure Lines 30"
- b. Distribution Lines (Laterals) 6" to 18"
- c. Lines to Drinking Fountains 30"
- d. Lines to Quick Couplers 30"
- e. Electrical Lines 24"

### **21.0.6.4 Piping**

All pipes shall be installed according to the following specifications.

#### **1. Rigid Plastic Pipe**

Exercise care in handling, loading unloading and storing plastic pipe and fittings; store plastic pipe and fittings under cover until ready to be installed; transport plastic pipe only on a vehicle with a bed long enough to allow the pipe to lay flat to avoid undue bending and concentrated external load. Repair all dented and damaged pipe by cutting out the dented or damaged section and rejoining with a coupling. In jointing, use only the specified solvent and make all joints in strict accordance with the manufacturer's recommended methods; give solvent welds at least 15 minutes set-up time before moving or handling; and 24 hours curing time before filling with water. If manufacturer's recommendations do not cover all aspects of jointing, the recommendations of Plastics Pipe Institute Technical Report TR10 shall be followed. Piping shall be snaked in the trench, centerload the pipe with a small amount of backfill to prevent arching and deflection under pressure. All piping shall be sloped to drain and shall not be installed when air temperature is below freezing.

#### **2. Flexible Plastic Pipe**

Shall be installed in strict accordance with the manufacturer's recommendation. If the manufacturer's recommendation does not cover all aspects of installation the recommendations of the Plastics Pipe Institute Technical Report TR8 shall be followed. Piping shall be sloped to drain. Saddle tee connections shall not be used. Pipe shall not be installed when air temperature is below freezing.

#### **3. Copper Pipe**

Shall be installed according to manufacturer's recommendations. When copper pipe is jointed to any metal pipe or equipment other than copper it shall be by means of dielectric unions. Pipe shall be sloped to drain.

#### **4. Galvanized Steel Pipe**

Make all cuts in galvanized pipe square. Cuts shall be thoroughly reamed with all rough edges and burrs removed. Use joint tape on male threads only. Pipe shall be sloped to drain.

### **21.0.6.5 Valves and Valve Boxes**

Installation of Valves and Valve Boxes shall be in accordance with the following:

#### **1. Gate Valves**

Shall be installed where shown on the Plans and shall be set plumb. Gate valves 6" and larger shall be anchored to a block of concrete to insure stability of the valve in an upright position. Anchor valve in such a manner that it may be removed and re-installed without breaking the concrete block.

#### **2. Valve Boxes**

Shall be installed where shown on the Plans and shall be set plumb. Gate valves 6" and larger shall be anchored to a block of concrete to insure stability of the valve in an upright position. Anchor valve in such a manner that it may be removed and re-installed without breaking the concrete block.

#### **3. Angle Valves and Drain Valves**

Shall be installed where shown on the Plans and also at other low points in the system as necessary to insure complete drainage of the system. Each valve not in a valve pit shall be provided with a C.I. Valve box with the lid set flush with the ground. Drain valves set below valve pits shall have PVC sleeves for key operation. Sleeves shall project a minimum of 12" from the pit bottom and shall have removable caps. A drainage sump shall be provided for each drain valve and shall contain a minimum of 4 cubic feet of gravel. See "Valve & Pit Piping Detail" of these Standard Construction Specifications.

#### **4. Quick Coupler Valves**

Shall be installed where shown on the plans and as shown in "Valve Pit & Piping Detail". Risers for quick couplers shall be schedule 40 galvanized. In lawn areas install quick coupling valves using a double swing joint top flush to final grade. In planting areas install with top 2" above grade.

#### **5. Manual Control Valves**

Shall be installed where shown on the Plans and in accordance with manufacturer's recommendations. All manual control valves shall be in valve pits or valve boxes.

#### **6. Electric Control Valves**

Shall be installed as shown in "Valve Pit & Piping Detail". Valves shall be installed in such a way that they are accessible for repairs and/or removal.

#### **21.0.6.6 Valve Pits**

Install valve pits where shown on the Plans and as shown in "Valve Pit & Piping Detail".

#### **21.0.6.7 Automatic Controllers**

Install controllers where shown on the Plans and in accordance with the manufacturer's recommendations and, if pedestal type, as shown on "Controller Pedestal Detail" of these Standard Construction Specifications.

#### **21.0.7 Flushing**

Before sprinkler heads are set, the lines shall be thoroughly flushed in order to make sure that there is no foreign matter in lines which could cause stoppage of the sprinklers. When the system has been fully completed, it shall be tested and the operation thereof demonstrated to the City.

#### **21.0.8 Inspection**

No work shall be covered up or enclosed until it has been inspected, tested and approved by the City. The Contractor shall thoroughly clean, adjust and balance all systems. The Contractor shall demonstrate the entire system to the City proving that all remote control valves are properly balanced, that all heads are properly adjusted for radius and arc of coverage and that the installed system is workable, clean and efficient.

#### **21.0.9 Testing**

The Contractor shall furnish all necessary testing equipment and personnel and test the system as follows:

- a. make all necessary provisions for thoroughly bleeding the line of air.
- b. Before testing, fill the line with water for a period of at least 24 hours.
- c. After valves have been installed, test all live water lines for leaks at a hydrostatic pressure of 150 psi for a period of two hours with all couplings exposed and with all pipe sections center loaded.
- d. Correct all leaks, and replace damaged or faulty pipe and retest until accepted by the City.

#### **21.0.10 Backfilling**

Trenches shall be carefully backfilled with suitable materials free from clods of soil or stones larger than three inches (3.) in maximum dimension. Deposit the backfill materials equally on both sides of the pipe in 6" layers and compact thoroughly. Puddling or "ponding" shall be required. An excess of water shall be avoided in order to prevent disturbance of the earth under and around the pipe and also to prevent undue pressure upon the pipe. Likewise, the amount of water used shall be controlled so as not to risk "floating" the pipe out of position. Adequate dikes shall be constructed along the trench to retain and guide the water.

When jetting is used, jets shall be of an approved design and of sufficient length to reach the bottom of each layer and the water supply shall be continuous. All costs incurred in

getting the water to the point of use for the above purposes shall be borne by the Contractor. Excavated material will generally be considered satisfactory for backfill purposes. All backfill material shall be free from rubbish, vegetable matter, frozen materials, or stones larger than three inches (3.) in maximum dimension. Any material not suitable for backfill or not used shall be removed from site by the Contractor. Backfill shall not be done in freezing weather except with written approval from the City. All trenches shall be left slightly mounded to allow for settlement after the backfilling is completed. The site of the work shall be continuously cleaned up of excess and/or waste materials as the backfilling progresses and shall be left in a neat and workmanlike condition to the satisfaction of the City. Any undue settling which results within one year after final acceptance of work shall be corrected by the Contractor and at the Contractor's expense including resurfacing as required.

### **21.0.11 Area Restoration**

Where trenches and lines cross existing roadways, paths, curbing, etc., damage to these shall be kept to a minimum and they shall be restored to as near original condition as possible. Match existing road section for blacktop paving thoroughly compacted sub-base, base course, bituminous course matching grades of existing paving. Blacktop curbs hot mix bituminous course material tamped and shaped to match adjoining curbs. Concrete paving or curbs concrete to match adjoining concrete work. The quality of the materials used in this restoration shall be equal to or better than the material which was removed, or as shown on the Plans or specified

### **21.0.12 Water Service**

#### **21.0.12.1 Scope**

This work consists of providing water service for the sprinkler system by connecting the system to existing park water lines and/or city water mains. The work includes the furnishing of all labor, supervision, construction equipment and materials including piping, valves, meters, meter pits and backflow prevention devices. All work required to complete the water service in conformance to the Plans and Specifications including excavation, trenching, concrete work pressure tests, and miscellaneous items of related work shall be preformed.

#### **21.0.12.2 Workmanship**

All materials and equipment shall be installed in a first class, workmanlike manner using workmen who are skilled and certified in their respective trades.

#### **21.0.12.3 Building Code**

All work shall be in accordance with the Denver Building Code, latest revision.

#### **21.0.12.4 Connection to Existing Park Water Lines**

Connection to Existing Park Water Lines shall be made by tapping sleeves, tees or crosses. All fittings shall have a design working pressure of 150 psi; all material shall conform to the requirements herein specified

### **21.0.12.5 Connections to City Water Mains**

Connections to City Water Mains shall be done in accordance with Denver Water Board Requirements and regulations.

### **21.0.12.6 Materials**

Unless otherwise noted or approved, all material shall conform to the following Specifications .

#### **1. Copper Pipe**

Shall be Type k copper, ASTM B-88. Fittings for copper pipe shall be wrought copper or cast bronze, 150 psi class. Joints shall be solder joints with 95-5 tin -antimony.

#### **2. Cast Iron Pipe**

Shall meet the requirements of AWWA Standards C-101 and C-106 for 150 psi working pressure. Unless otherwise noted, cast iron pipe shall have push on type joints approved by the Construction Project Manager and installed in strict accordance with manufacturers recommendations. Cement lining shall conform to AWWA Standard C-104. Rubber gasket joints shall conform to AWWA Standard C-111.

#### **3. Curb Valves**

All curb valves between the main and the meter shall be rated at 175 psi w.o.g., and shall open by turning to the right. Curb valves shall be all bronze with "O" ring seals. Curb valves shall have cast iron curb boxes complete with lid and foot piece designed for use with the curb valve. Make and size shall be as shown on the Plans. Curb valves must be approved by the Denver Water Board.

#### **4. Gate Valves**

All gate valves used in conjunction with water meters shall be as approved by the Denver Water Board.

#### **5. Water Meter**

The size shall be as shown on the Meter and shall be of the type approved by the Denver Water Board.

#### **6. Backflow Preventer Device**

Shall be of the type as shown on the Plans. The backflow prevention device must be approved by the Denver Water Board and shall be furnished with inlet and discharge shut-off valves.

#### **7. Pit for Water Meter**

Shall be as per Denver Water Board requirements. Water Service installation shall conform to the following specifications.

- a. Excavation.** The width of the trench in which the pipe will be placed shall be sufficient to allow thorough tamping of suitable backfill material under, around and over the pipe. All excavated materials shall be deposited at least two feet away from any trench side.



Any trench deeper than 6 feet shall be adequately shored and/or braced for safety considerations. If ground water is encountered during trench excavation above the elevation of the bottom of the pipe bell all water shall be removed until the pipe has been installed and the trench backfilled.

**b. Cast Iron Pipe** shall be installed in accordance with the recommendations of the manufacturer. Unless noted otherwise or approved by the Construction Project Manager, cast iron pipe shall be embedded in and covered by a minimum of 6 inches of pea gravel; max. 3/8" dia.

**c. Copper Pipe** shall be installed in accordance with the manufacturer's recommendations. When copper pipe is jointed to any metal pipe or equipment other than copper, brass or bronze, it shall be by means of dielectric unions.

**d. Testing** required for this portion of the system shall be the same as that described in Section 21.3 of these Standard Construction Specifications.

**e. Backfilling** requirements shall be the same as those described in Section 21.3 of these Standard Construction Specifications.

**f. Restoration.** Requirements for restoring area shall be the same as those described in Section 21.3 of these Standard Construction Specifications.

## **21.0.13 Electrical Service**

### **21.0.13.1 Scope**

This work consists of providing electrical service to the automatic sprinkler controllers. The work includes the furnishing of all labor, supervision, construction equipment and materials including wire, conduit, devices and appurtenances. All work required to complete the electrical service in conformity with the Plans and specifications including excavation, trenching and miscellaneous items of related work shall be performed.

### **21.0.13.2 Workmanship**

All materials and equipment shall be installed in a first class, workmanlike manner, using workmen who are skilled and certified in their respective trades.

### **21.0.13.3 Code**

All work shall be done in accordance with the Denver Building Code and the National Electrical Code, latest edition.

### **21.0.13.4 Materials and Installation**

Material and Installation shall conform to the following specifications.

#### **1. Wire**

Shall be as shown on the Plans.

#### **2. Sleeves**

Shall be Schedule 40 galvanized steel. All wires buried in roadways shall have sleeves.

### **3. Service Connections**

Coordinate with Public Service Company, Street Lighting Division for electrical service connection.

**End of Specification**



CITY AND COUNTY OF DENVER  
ENGINEERING DIVISION

## Wastewater Capital Projects Management Standard Construction Specification

---

### 22.0 Seeding

#### 22.1.1 General

This work shall consist of furnishing and drilling in seed or hydromulch seeding in accordance with these Standard Construction Specifications and as shown on the Plans. The work shall also include soil preparation, furnishing and spreading fertilizer and installation of mulch and erosion control blanket.

All areas shall be seeded by drilling. In areas where access is a problem, seeding shall be conducted by hydromulch seeding as directed by the Construction Project Manager. Mulch shall be required in all areas that are drilled.

Seeding and the installation of erosion control in certain areas designated by the Construction Project Manager may be permitted before the construction of certain areas to take advantage of growing conditions.

Seeding shall not be accomplished when the ground is frozen or otherwise unillable.

Seeded areas damaged due to circumstances beyond the Contractor's control shall be repaired and reseeded as ordered. Payment for this corrective work shall be at the contract price.

#### 22.1.2 Grading

All areas requiring seeding shall be cleared of vegetation, roots, oversized materials and all other material which is objectionable in the opinion of the Resident Engineer and shall be disposed of as specified in Section 2.0, Site Preparation.

### 22.2 Materials

#### 22.2.1 Seed

All seed shall be furnished in bags or containers clearly labeled to show the name and address of the supplier, the seed name, the lot number, net weight, the percentage of purity and germination. All brands furnished shall be free from such noxious seeds such as Russian or Canadian Thistle, European Bindweed, Johnson Grass and Leafy Spurge. All seed furnished shall be from a lot that has been tested by a recognized laboratory for seed

testing within six months prior to the date of delivery. Seed which has become wet, moldy, or otherwise damaged in transit or in storage will not be acceptable.

Seed Type. The seeds acceptable for drilling and hydromulch seeding are: (1) White Dutch Clover, (2) Fairway Wheatgrass, (3) Perennial Rye, (4) "Sodar" Streambank Wheatgrass, and (5) Luna Pubescent or Western Wheatgrass.

Seeding Mixture. The seeding mixture shall be applied at a bulk rate per acre as follows for hydromulch seeding:

	Pounds	Purity	Germination
(1) White Dutch Clover	1.1	96%	90%
(2) Fairway Wheatgrass	2.9	95%	85%
(3) Perennial Rye	3.5	98%	90%
(4) Sodar Streambank Wheatgrass	5.2	97%	92%
(5) Luna Pubescent Wheatgrass	8.9	93%	85%
(6) Western Wheatgrass	10	80%	80%

The seeding rate per acre for drilling shall be one-half the rate of hydromulch seeding.

- c. Seed Purity. Seed and seed labels shall conform to all current State and Federal regulations and will be subject to the testing provisions of the Association of Official Seed Analysis.

If seed available on the market does not meet the minimum purity and germination percentages specified, the Contractor must compensate for a lesser percentage of purity of germination by furnishing sufficient additional seed to equal the specified product. Product comparison shall be made on the basis of pure live seed in pounds. The formula used for determining the quantity of pure live seed (PLS) shall be:

$$\text{Pounds of Seed} \times (\text{Purity} \& \text{Germination}) = \text{Pounds of Live Seed (PLS)}$$

### 21.2.2 Fertilizers

Fertilizers shall consist of a standard brand fertilizer having a minimum content of 18% available nitrogen. The percentage of nitrogen content shall be certified at the time of use.

Super Phosphate (45% minimum Phosphate when called for on the Plans) will be used on subsoil where all topsoil has been removed. The rate of application shall be approximately 250 pounds per acre.

### 22.2.3 Erosion Control Blanket

Erosion Control Blanket. The blanket shall consist of a material or combination of materials that are biodegradable after a sufficiently long enough period of time to insure germination and rooting of grass seeds. The blanket shall have uniform openings and consist of knitted

yarn in a material that has enough strength and flexibility that allows it to be placed over uneven ground surfaces. The erosion control blanket shall be furnished in rolls that have a width of 4' minimum to 10' minimum. Length and weight of the rolls may vary depending on the manufacturer and the blanket material.

Pins and Staples. Pins or staples shall be made of wire .091" or larger in diameter. "U" shaped staples shall have legs 6" long and 1" crown." T" shaped pins shall have a minimum length of 8" after bending. The bar of the "T" shall be at least 4" long with the single wire end bent downward approximately ¾".

#### **22.2.4 Tackifier**

A tackifier will be required with all hydromulch seeding.

#### **22.2.5 Hydromulch**

Wood cellulose fiber for hydromulch seeding shall not contain any substance or factor, which might inhibit germination or growth of grass seed. It shall be dyed an appropriate color to allow metering of its application.

The wood cellulose fibers shall have the property of becoming evenly dispersed and suspended when agitated in water. When sprayed uniformly on the surface of the soil, the fibers shall form a blotterlike ground cover, which readily absorbs water, and allows infiltration to the underlying soil. Weight specifications from suppliers, and for all applications, shall refer only to air dry weight of the fiber, a standard equivalent to ten (10%) percent moisture. The mulch material shall be supplied in packages having a gross weight not in excess of one hundred (100) pounds, and shall be marked by the manufacturer to show the air dry weight content. Suppliers shall certify that the laboratory and field testing of their product has been accomplished and that it meets all of the foregoing requirements pertaining to wood cellulose fiber mulch.

#### **22.2.6 Mulch**

Materials for straw mulch shall consist of straw of oats, barley, wheat, or rye and shall not contain seed of noxious weeds.

Straw or hay in such an advanced stage of decomposition as to smother or retard the normal growth of grass will not be accepted. Old dry straw which breaks in the crimping process in lieu of bending will not be accepted.

### **22.3 Construction**

#### **22.3.1 Grade Preparation**

Prior to seeding, the top 4 inches of the surface shall be tilled and brought to the desired line and grade, except where seeding follows so closely behind the initial grading as to make special seeding preparation unnecessary. Areas to be seeded shall be tilled or handworked into a reasonably even and loose sandbed immediately in advance of the seeding.

### **22.3.2 Seeding**

Hydromulch Seeding. As required, cellulose fiber mulch shall be added with the proportionate quantities of water and other approved materials in the slurry tank. All ingredients shall be mixed to form a homogeneous slurry. Using the color of the mulch as a metering agent, the operator shall spray-apply the slurry mixture uniformly over the designated seeded area. Unless otherwise ordered for specific areas, wood cellulose fiber mulch shall be applied at the rate of 1500 pounds per acre or 35 pounds per 1,000 square feet.

Hydromulch seeding shall not be done in the presence of free surface water resulting from rains, melting snow or other causes.

Drilling. Seeding shall be accomplished by means of an approved mechanical power drawn drill, followed by packer wheels or drag chains. Seed shall not be drilled during windy weather or when the ground is frozen or otherwise untillable.

Mechanical power drawn drills shall have depth bands set to maintain a planting depth recommended for the type of seed being drilled and shall be set to space the rows not more than 7 inches apart.

If the inspections indicate the stripe wider than the specified space between the rows planted have been left or other areas skipped, the Construction Project Manager shall require immediate re-sowing of seed in such areas at the Contractor's expense.

All seeding shall be done between September 1 to September 15 and March 2 to April 15 of the Calendar year of construction.

The Contractor shall be responsible for maintaining and watering areas seeded for a period of 7 weeks after the time of seeding. Areas in which there is not a satisfactory stand at the expiration of this 7-week period shall be re-seeded. Sprinkling of the seeded areas shall be carefully done in such a manner as to avoid standing water, surface wash or scour. Areas seeded and so maintained shall be protected against damage by vehicle or pedestrian traffic by the use of barriers and appropriate warning signs. Areas shall be re-seeded as many times as is required to establish a significant growth of grass seedlings (a minimum of 25 plants per square feet).

### **22.3.3 Mulch**

After seeding has been completed, a rate of 11/2 tons of hay or straw per acre, or as directed, shall be applied uniformly, crimped in with a crimper or other approved equipment. The Construction Project Manager may order the employment of hand crimping operations on such areas where excessive ground slopes or confined areas would cause unsatisfactory crimping by mechanical methods.

The seeded area shall be mulched and crimped within 24 hours after seeding. Areas not mulched and crimped within this 24-hour period must be reseeded with the specified seed mix at the Contractor's expense prior to mulching or crimping.

On steep slopes or other specific areas as shown on the plans, which are difficult to mulch or crimp by conventional methods, burlap or other blanketing materials properly anchored or secured may be used when approved by the Construction Project Manager.

#### **22.3.4 Fertilizer**

Fertilizer shall be spread uniformly at the rate specified and washed into the soil by the application of water or tilled into the top two inches of soil. Sufficient fertilizer shall be evenly distributed to provide 50 pounds of free nitrogen per acre.

#### **22.3.5 Erosion Control Blanket (Channels, Etc.)**

Erosion control blanket shall be installed on each side and bottom of the low flow channel as shown on the drawings and as directed by the Construction Project Manager. An additional row of blanket (approximately 4' to 5' wide) may be required in areas of steep slopes or southern exposures.

The area to be covered shall be properly prepared, fertilized and seeded before the erosion control blanket is applied. The blanket shall be placed in accordance with the manufacturer's recommendations and in such a manner to insure contact with the ground creating maximum protection for the newly planted seed. In the low flow channel, the erosion control blanket shall be applied in the direction of the flow of the water, butted snugly at the sides and lapped approximately one foot. On slopes the blankets may be applied either horizontally or vertically to the slope as directed by the Construction Project Manager. Ends and sides shall be butted snugly. The blanket shall be stapled down at intervals in accordance with the manufacturer's specifications.

The Contractor shall also be responsible for maintaining and caring for the erosion control blanket for a 7-week period. All blankets that are disturbed during this period will be replaced and restapled by the Contractor.

**End of Specification**



CITY AND COUNTY OF DENVER  
ENGINEERING DIVISION

## Wastewater Capital Projects Management Standard Construction Specification

---

### 23.0 Storm Water Management

#### 23.0.1 Definitions

Definitions used for this Section shall consist of those listed in Title 1 of the City and County of Denver "Standard Specifications for Construction, General Contract Conditions" as referenced within the Contract Documents, those listed within the City and County of Denver Construction Activities Stormwater Manual (CASM), and the following:

##### 23.0.1.1 Basis of Payment

The terms under which Work is paid, as a designated Pay Item, in accordance with the quantity measured and based upon the associated Measurement and Payment description.

##### 23.0.1.2 Best Management Practices (BMPs)

Schedules of activities, prohibitions of practices, installation of devices, maintenance procedures, and other management practices deployed to stabilize the construction site to prevent or reduce the pollution of State Waters (see definition below). Stormwater BMPs can be classified as "structural" (i.e., devices installed or constructed on a site) or "non-structural" (procedures, such as modified landscaping practices).

##### 23.0.1.3 Colorado Department of Health and Environment (CDPHE)

State of Colorado, Water Quality Control Division responsible for issuance of State Construction Stormwater Permit.

##### 23.0.1.4 Construction Activities Stormwater Discharge Permit (CASDP)

Permit issued by the City for compliance with City & County of Denver Revised Municipal Code and Department of Public Works Rules & Regulations concerning the discharge of pollutants in storm generated runoff from construction sites to Municipal Separate Storm Sewer System (MS4, see definition below) or State Waters, via the Municipal Separate Storm Sewer System (MS4).

**23.0.1.5 Construction Activities Stormwater Manual (CASM):** City and County of Denver Construction Activities Stormwater Manual (CASM), current edition.



### **23.0.1.6 Colorado Department of Transportation (CDOT)**

State agency that has published standards for Erosion Control with accompanying Erosion Control Supervisor certification courses.

### **23.0.1.7 Erosion Control Supervisor (ECS)**

The Contractor's Erosion Control Supervisor, to perform duties as described in this Section. The ECS shall be properly trained in BMPs per requirements of Part V below, and shall be under the direction of a Professional Engineer licensed in the State of Colorado when performing any modifications to the Project Stormwater Management Plan (SWMP).

### **23.0.1.8 Final Stabilization**

Point of construction when all ground surface disturbing activities at the site have been completed and uniform vegetative cover has reached 70% of pre-disturbance vegetative cover, or equivalent permanent features have been employed. At this point, all temporary BMPs can be removed, all construction and equipment maintenance wastes have been disposed of properly; and all elements of the Stormwater Management Plan have been completed.

### **23.0.1.9 Major SWMP Modification**

Changes to the original SWMP that removes or adds additional area to the Project, or modifies the final hydrology or drainage of the Project. A Major SWMP Modification requires the submission of revised Storm water Management Plan (SWMP) elements to the Permit Authority for review and approval. Any adjustments to a SWMP must be performed either by or under the direction of a Professional Engineer licensed in the State of Colorado.

### **23.0.1.10 Minor SWMP Modification**

Modification to the SWMP that does NOT increase the scope or change hydrology of the Project but: modifies/improves specific BMPs in use at site, indicates progression in phasing of the Project, or specifies relocation of previously approved BMPs within the Project. Any adjustments to a SWMP must be performed either by or under the direction of a Professional Engineer licensed in the State of Colorado.

**23.0.1.11 Municipal Separate Storm Sewer System (MS4):** A conveyance or system of conveyances (including roads with drainage systems, municipal streets, catch basins, curbs, gutters, ditches, man-made channels, or storm drains):

- a) owned or operated by a State, city, town, county, district, association, or other public body (created by or pursuant to State law) having jurisdiction over disposal of storm water or other wastes, including special districts under State law such as a sewer district, flood control district or drainage district, or similar entity, or a designated and approved management agency under Section 208 of the Federal Clean Water Act that discharges to State Waters;
- b) designed or used for collecting or conveying storm water;

- c) which is not a combined sewer; and
- d) which is not part of a Publicly Owned Treatment Works (POTW).

#### **23.0.1.12 Permit Authority**

The Department authorized by the City to review and process CASDP Applications for Capital and/ or governmental sponsored Projects. The responsible City department serving as the Permit Authority is the Public Works Project Controls Office. As a clarification, the Development Services Department of the City serves as the point of intake and permit processing center.

#### **23.0.1.13 Permit Enforcement Authority**

The Department authorized by the City to inspect and enforce CASDP Rules and Conditions for all construction Projects within the City's MS4 Boundary. The responsible City department serving as the Permit Enforcement Authority is the Wastewater Management Division of the Department of Public Works.

#### **23.0.1.14 State Construction Stormwater Permit**

Colorado Revised Statutes require that all construction sites/development Projects, which, by definition, disturb one or more acres in area, shall be covered by a State issued general permit for construction activities. Information on the application requirements for the State permit can be obtained by phone at 303-692-3500; or by visiting their offices located at 4300 Cherry Creek Drive South, Denver, CO 80246 – 1530 or on the Web at: [www.cdphe.state.co.us](http://www.cdphe.state.co.us)

#### **23.0.1.15 State Waters**

Any and all surface waters which are contained in or flow in or through this State, not to include waters in sewage systems, waters in treatment works of disposal systems, waters in potable water distribution systems, and all water withdrawn for use until use and treatment have been completed. Examples of State Waters include, but are not limited to, perennial streams, intermittent or ephemeral gulches and arroyos, ponds, lakes, reservoirs, irrigation canals or ditches, wetlands, stormwater conveyances (when they discharge to a surface water), and groundwater.

#### **23.0.1.16 Substantial Completion of Erosion Control**

Point of construction when permanent BMPs have been installed, initial growth is in place, and the site is waiting for vegetative cover to reach 70% of pre-disturbance vegetative cover.

#### **23.0.1.17 Stormwater Management Plan (SWMP)**

A SWMP establishes a minimum standard to construct, install, maintain, and remove required BMPs during the life of the Contract to prevent or minimize pollution of stormwater due to erosion, sediment transport, and construction related pollutant generated during all phases of the Project.

## 23.0.2 General

This Work shall consist of constructing, installing, maintaining, and removing when required, BMPs during the life of the Contract until Final Stabilization to prevent or minimize erosion, sedimentation, and pollution of any waters including storm, drainageways, MS4, State Waters, and/ or wetlands. Work under this Section includes the Contractor obtaining required Permits, utilizing SWMP elements provided in the Contract, and/ or SWMP elements specifically prepared by the Contractor as defined herein. The work shall also consist of providing on-going maintenance and monitoring of the SWMP as may be necessary due to the specific and/ or dynamic needs of the Project as well as meet all requirements set forth within the CASM.

The Contractor shall coordinate the construction of temporary BMPs with the construction of permanent BMPs to assure economical, effective, and continuous erosion and sediment control and water pollution prevention throughout the construction period until Final Stabilization is achieved

When a provision of this Section or an order by the Permit Enforcement Authority requires that an action be immediate or taken immediately, it shall be understood that the Contractor will at once begin effecting completion of the action and pursue it to completion in a manner acceptable to the Permit Enforcement Authority, and in accordance with applicable Permitting requirements.

A SWMP consists of the following elements:

- (i) CASDP Narrative Worksheet with Narrative Report. The Narrative Report and supporting documents should fully address the methods to be used to prevent sediment, debris, and other pollutants from entering the MS4 and/ or State Waters in and around the Project area. Proposed structural and non-structural BMPs should be described with sufficient implementation detail to insure that the logical phases of the proposed construction Project meet the performance standards listed in the CASM.
- (ii) Proposed site drawings and Best Management Practice (BMP) installation details as they apply to the site conforming to the Urban Storm Drainage Criteria Manual, Vol. 3, "Best Management Practices", most current version as issued by the Urban Drainage and Flood Control District (UDFCD), or those established by the City's Department of Public Works. If erosion control drawings were included within the bid documents for the Project, they shall be used for bid purposes and initial planning/ deployment of BMPs on the Project. If provided drawings are signed/ sealed by a Professional Engineer, they have been pre-approved by the Permit Authority and may be used without revision for purposes of submitting for CASDP. If provided drawings do not have signature/ seal of Professional Engineer licensed by the State of Colorado, they will require revision by the Contractor with

Professional Engineer signature/ seal prior to submission to the City and County of Denver for CASDP.

- (iii) Supporting documentation related to proposed BMPs that are not currently identified in UDFCD Vol. 3 or as otherwise published by the City.

Any preparation of or adjustments to a SWMP must be performed either by or under the supervision of a Professional Engineer licensed in the State of Colorado. SWMP elements submitted to the City shall also meet currently established criteria of the CDPHE as the SWMP must meet all local, State and Federal requirements.

### **23.0.3 Materials**

Materials to be used for BMPs shall conform to each specific detail as set forth within the approved project SWMP or as noted within the Contract Documents.

### **23.0.4 Erosion Control Permit**

The applicable storm water management bid item included within the contract documents will indicate which of the following scenarios applies for the project.

#### **23.0.4.1 Scenario 1: CASDP is not required.**

A SWMP is currently not required for this project as the proposed disturbed area and/ or proximity to stream does not meet the minimum criteria for requiring a CASDP. All portions of this specification following this subsection are hereby deleted and shall not be made part of the Project. However, the responsibilities for minimizing sediment pollution from the Project have not been waived, and as such, the City hereby requires the Contractor to perform as specified within this subsection. All costs for performance of the following are included within the associated Storm Water Management bid item included within the contract and shall not be paid for separately.

- a) A CASDP Permit will not be required for this project, however, the Contractor and/or their authorized agents shall ensure that all potential pollutants generated during demolition, excavation, trenching, boring, grading, or other construction Work associated with this permit, be prevented from discharge to stormwater conveyance systems in the vicinity of the Project.
- b) The Contractor shall remove all sediment, mud, construction debris, or other potential pollutants that may have been discharged to or, accumulate in the flow lines of storm drainage appurtenances and public rights of ways of the City and County of Denver as a result of construction activities associated with this Project. All removals shall be conducted in a timely manner.
- c) The Contractor shall be held responsible for remediation of any adverse impacts to the MS4, State Waters, waterways, wetlands, and or other public or private properties, resulting from work done as part of this Project.

- d) The Contractor shall insure that all loads of cut and fill material imported to or exported from the Project shall be properly covered to prevent loss of the material during transport on public rights of way.” (Sec.49-552; Revised Municipal Code)
- e) Approved erosion and sediment control ‘Best Management Practices’ shall be maintained and kept in good repair for the duration of the Project. All necessary maintenance and repair shall be completed immediately upon discovery of any deficiency or defect.
- f) The Contractor shall implement the following Best Management Practices (BMPs) on site during construction:
- i. **VEHICLE TRACKING CONTROL:** This BMP is required at all access points to a construction site that are used by vehicular traffic or construction equipment.
  - ii. **INLET PROTECTION:** This BMP is required on all existing or proposed storm sewer inlets in the vicinity of the construction site that may receive site runoff. The BMP must be appropriate to the type of storm inlet and appropriate for the ground surface at the inlet.
  - iii. **INTERIM SITE STABILIZATION:** This BMP is required to provide a measure for preventing the discharge of sediment from construction sites where overlot grading or other site disturbance has occurred. This BMP is particularly necessary on sites where construction activities/disturbance will be limited to small areas of the project site. Acceptable BMPs include:
    - Preserving existing vegetation
    - Seeding and planting
    - Mulching
    - Mulching and seeding
    - Temporary/Permanent re-vegetation operations
    - Chemical soil stabilizer application (requires Permit Enforcement Authority approval)
  - iv. **WASTE MANAGEMENT/CONTAINMENT:** This BMP requires that all construction wastes, fuels, lubricants, chemical wastes, trash, sanitary wastes, contaminated soils or debris shall be contained on site, protected from contact with precipitation or surface runoff, periodically removed from the construction site, and properly disposed of.
  - v. **SPILL PREVENTION /CONTAINMENT:** This BMP defines the measures proposed for preventing, controlling, or containing spills of fuel, lubricants, or other pollutants; and protecting potential pollutants from contact with precipitation or runoff.
  - vi. **CHUTE WASHOUT CONTAINMENT:** Water used in the cleaning of ready mixed concrete truck delivery chutes shall be discharged into a predefined, bermed containment area on the job site. The required

- containment area is to be bermed so that wash water is totally contained. Wash water discharged into the containment area shall be allowed to infiltrate or evaporate. Dried concrete waste shall be removed from the containment area and properly disposed of.
- vii. Should a predefined bermed containment area not be available due to the project size, or lack of an area with a suitable ground surface for establishing a containment area, proper disposal of ready mix washout and rinse off water at the job site shall conform to the approved techniques and practices identified in the Colorado Department of Public Health & Environment's training video entitled "Building For a Cleaner Environment, Ready Mix Washout Training", and its accompanying manual entitled, "Ready Mix Washout Guidebook, Vehicle and Equipment Washout at Construction Sites."
  - viii. The direct or indirect discharge of water containing waste concrete to the storm sewer system is prohibited (Sec.56-102a, c; Revised Municipal Code, City and County of Denver).
  - ix. Information about, or copies of the video and training manual are available from the Water Quality Control Division, Colorado Department of Public Health & Environment, 4300 Cherry Creek Drive South, Denver, Colorado 80222-1530, (303) 692-3555.
  - x. **STREET SWEEPING:** This BMP requires that paved surfaces which are adjacent to construction sites be swept in a timely manner when sediment and other materials are tracked or discharged on to them. Either sweeping by hand or use of street sweepers is acceptable. Street sweepers using water while sweeping is preferred in order to minimize dust. Flushing off paved surfaces with water is prohibited.
  - xi. **PERIMETER CONTROL:** This BMP requires that a construction site install a perimeter control measure along the edge of the construction site, to prevent, or filter the discharge of surface runoff from the construction site. The type of perimeter control used shall be determined based on site conditions and location. Maintenance and repair of the control measure shall occur as needed, in a timely manner.
  - xii. **STOCK PILES:** Soils that will be stockpiled for more than thirty (30) days shall be protected from wind and water erosion within fourteen (14) days of stockpile construction. Stabilization of stockpiles located within 100 feet of an MS4 or State Waters, or with slopes 3 to 1 or greater shall be completed within seven (7) days following stockpile construction. Stabilization and protection of the stockpile may be accomplished by any of the following: Mulching, Temporary/Permanent Revegetation Operations, Chemical Soil Stabilizer Application (requires Permit Enforcement Authority approval), or erosion control matting/Geotextiles. If stockpiles are located within 100 feet of an MS4 or State Waters, a drainageway or the site perimeter, additional sediment controls shall be required.

- xiii. **SAW CUTTING OPERATIONS:** The Contractor shall protect all storm sewer facilities adjacent to any location where pavement cutting operations involving wheel cutting, saw cutting, or abrasive water jet cutting are to occur. The Contractor shall remove and properly dispose of all waste products generated by said cutting operations on a daily basis or as needed throughout the work day. The discharge of any water contaminated by waste products from cutting operations to the storm sewer system is prohibited. (Sec.56-102a, c; Revised Municipal Code, City and County of Denver).”

**23.0.4.2 Scenario 2: CASDP and State Construction Storm Water Permit(s) are required. No SWMP element(s) are included. The City has not provided SWMP elements nor obtained required CASDP or State Construction Stormwater Permit(s) in advance of bid.**

SWMP elements have not been included in the Contract Documents. The Contractor shall plan and coordinate with the Permit Authority to prepare all required SWMP elements and obtain required CASDP. Per CASDP requirements, the Contractor shall obtain the endorsement of a Professional Engineer licensed in the State of Colorado for preparation of the initial SWMP and/or any proposed Major or Minor SWMP Amendments. This will require the Contractor to provide or retain a Professional Engineer or subcontract with the original Professional Engineer that prepared the Bid Documents.

The Contractor is hereby made aware that the Permit Authority allots up to 3 weeks per review cycle for CASDP Permit applications (2 review cycles are not uncommon).

Per definition, a Major SWMP Modification requires the submission of revised SWMP elements to the Permit Authority for review and approval.

Prior to issuance of a Notice to Proceed, the Contractor shall obtain required State Construction Stormwater Permit(s) as applicable.

**23.0.4.3 Scenario 3: CASDP and State Construction Storm Water Permit(s) are required and “For reference only” SWMP erosion control drawings have been provided. The City has not obtained required CASDP or State Construction Stormwater Permit(s) in advance of bid.**

The Contractor shall submit a complete SWMP and application to the Permit Authority to obtain the required CASDP. The Contractor shall use the provided “For reference only” erosion control drawings provided in the Contract as a starting point for preparation of required SWMP elements (as required for CASDP) and for general information as to the origin of pay items included in the Bid Documents. The included erosion control drawings have been previously reviewed by the Permit Authority, and the BMPs shown therein have been found to be generally acceptable by the Permit Authority.

It shall be the responsibility of the Contractor to prepare and acquire approval of a complete SWMP and obtain a CASDP from the Permit Authority prior to beginning construction. The

Contractor is hereby made aware that the Permit Authority allots up to 3 weeks per review cycle for CASDP applications (2 review cycles are not uncommon).

Per CASDP requirements, the Contractor shall obtain the endorsement of a Professional Engineer licensed in the State of Colorado for preparation of the initial SWMP and/ or any proposed Major or Minor SWMP Amendments. This will require the Contractor to provide or retain a Professional Engineer or subcontract with the original Professional Engineer of the "For reference only" erosion control drawings.

Per definition, a Major SWMP Modification requires the submission of revised SWMP elements to the Permit Authority for review and approval.

Prior to construction, the Contractor shall obtain the required State Construction Stormwater Permit(s) as applicable.

**23.0.4.4 Scenario 4: CASDP and State Construction Storm Water Permit(s) are required and completed SWMP has been included. The City has obtained CASDP in advance of bid. The City has not obtained State Construction Stormwater Permit prior to bid.**

An approved SWMP has been prepared and CASDP obtained by the City prior to bidding of the Project and as such must be properly transferred to the Contractor prior to the start of construction. The SWMP has been provided within the Bid Documents and shall be made a part of the Contract. The Contractor shall coordinate with the Construction Project Manager and Permit Authority to perform the necessary transfer of CASDP from City to Contractor prior to the start of construction. The Permit transfer will be performed at no cost to the Contractor.

Prior to transfer of CASDP, additional elements shall be completed by the Contractor before the CASDP will be transferred from City to Contractor:

- a) Complete Sections B&E (Permittee & Site Supervisor) of the CASDP "Narrative Report Information Worksheet".
- b) Prepare a complete SWMP including any required adjustments for proposed construction phasing, staging areas, or additional items necessary to address applicable project specific Permit requirements. This will require the Contractor to provide or retain a Professional Engineer or subcontract with the original Professional Engineer that prepared the Bid Documents.
- c) Complete the "Construction Scheduling" section of the "Narrative Report Information Worksheet".
- d) Include specific methods and/or BMPs that the Contractor will implement to address hazardous spill prevention/ containment response.
- e) Provide any "Additional Documentation and Correspondence" applicable to the Contractor as stated in the CASM. This will require the Contractor to provide or retain a Professional Engineer or subcontract with the original Professional Engineer that prepared the Bid Documents.



If deemed necessary, the Contractor may propose modifications to the approved SWMP once the CASDP has been transferred to the Contractor. Per CASDP requirements, the Contractor shall obtain the endorsement of a Professional Engineer licensed in the State of Colorado for any proposed Major or Minor SWMP Amendments. This may require the Contractor to provide or retain a Professional Engineer or subcontract with the original Professional Engineer of the “For reference only” erosion control drawings.

Per definition, a Major SWMP Modification requires the submission of revised SWMP elements to the Permit Authority for review and approval.

Prior to construction, the Contractor shall obtain the required State Construction Stormwater Permit(s) as applicable.

### **23.0.5 Construction Requirements**

#### **23.0.5.1 Construction Implementation**

The Contractor shall incorporate into the Project all BMPs as outlined in the accepted Critical Path Method Construction schedule.

#### **23.0.5.2 Alterations to Project BMPs**

The Contractor shall design and implement BMPs for correcting potential conditions unforeseen during design of the Project, or as possible for emergency situations, which arise during construction. The Project’s SWMP, UDFCD Vol 3 standards and details, and CDOTs “Erosion Control and Storm-Water Quality Guide,” and any approved modification to these documents as proposed by the Contractor, shall be used as reference documents for the purpose of designing appropriate BMPs. Measures and methods proposed by the Contractor to deal with unforeseen conditions shall be reviewed and approved in writing by the Permit Enforcement Authority and the Project Construction Engineer prior to implementation and construction.

In an emergency situation, the Contractor shall use best judgment for immediately responding to the emergency situation as it arises.

All costs associated with revising the BMPs utilized throughout the project, for its duration, shall be included within the applicable Storm Water Management bid item. No separate or additional payment shall be made.

#### **23.0.5.3 Permits**

The Contractor shall obtain all required permits for the Project including those required by federal, state, and local agencies. The Contractor shall obtain (or transfer from the City when specified) required erosion control and water quality permits and shall be responsible for compliance with all requirements under any such permits.

#### **23.0.5.4 Erosion Control Supervisor**

Contractor shall assign to the Project an employee or subcontractor to serve as Erosion Control Supervisor (ECS). The ECS shall be a person other than the Contractor's superintendent, foreman, or equivalent supervisory position. The ECS shall be experienced in aspects of BMP construction and have satisfactorily completed a Colorado DOT or equivalent ECS training program authorized by the City. Proof that this requirement has been met shall be submitted to the City's Construction Project Manager at least ten working days prior to the beginning of any soil disturbance work. A list of authorized ECS training programs is available from the City upon request. Additionally, per definition, the ECS shall be under the direction of a Professional Engineer licensed in the State of Colorado when performing any modifications to the Project Stormwater Management Plan (SWMP).

The ECS shall be responsible for oversight of the implementation, maintenance, and revision of the SWMP for the duration of the Project. The ECS's responsibilities shall be as follows:

- a) Ensure compliance with all water quality permits or certifications in effect during the construction work.
- b) Supervise the installation, construction, and maintenance of all BMPs specified in the Contract and coordinate the construction of BMPs with all other construction operations.
- c) Direct the implementation of suitable BMPs as necessary to correct unforeseen conditions or emergency situations. Direct the dismantling of those features when their purpose has been fulfilled due to completion of each Project phase unless the Permit Enforcement Authority agrees that the features be left in place.
- d) Inspect the construction site and document inspection activities at least every seven (7) days and immediately following any precipitation or snowmelt event with the potential to cause surface erosion. If no land disturbing construction activities are present during a storm event, post-storm event inspections shall be conducted prior to commencing any new land disturbing construction activities, but no later than seventy-two (72) hours following the storm event.
- e) Attend the preconstruction conference, erosion control preconstruction inspection, Project scheduling meetings, weekly construction/ field meetings, substantial completion and final stabilization inspections, and other meetings regarding construction that could impact water quality.
- f) Evaluate all non-stormwater coming onto the site, such as springs, seeps, and landscape irrigation return flow. If such flow is identified, the ECS shall propose appropriate SWMP modifications to the Contractor to protect off-site water from becoming contaminated with sediment or other pollutants.
- g) Coordinate with the Contractor to implement necessary actions to reduce anticipated or presently existing water quality or erosion problems resulting from construction activities.
- h) Coordinate with the Contractor to ensure all labor, material, and equipment deployed to meet SWMP requirements is judged appropriately.
- i) During construction, update and record the following items in the SWMP as changes occur:

- i. Construction boundaries (may require Major SWMP Modification)
  - ii. Areas of disturbance (may require Major SWMP Modification)
  - iii. Areas used for storage of construction materials, equipment, soils, or wastes.
  - iv. Location of any dedicated asphalt or concrete batch plants.
  - v. Location of construction offices and staging areas.
  - vi. Location of work access routes during construction.
  - vii. Location of borrow and waste.
  - viii. Location of temporary and permanent stabilization
  - ix. The ECS shall start a new site map before the current one becomes illegible. All site maps shall remain with the SWMP paperwork.
- j) Amend the SWMP whenever there are: additions, deletions, or changes in locations of BMPs. SWMP revisions shall be recorded immediately. Items shall be dated and signed at time of occurrence. Specifically, amendments shall include the following:
- i. A change in design, construction, operation, or maintenance of the site which would require the implementation of new or revised BMPs; or
  - ii. Changes when the SWMP proves to be ineffective in achieving the general objectives of controlling pollutants in stormwater discharges associated with construction activity.
  - iii. Changes when temporary BMPs are no longer necessary from changes in Project phase and are removed. All inspection and maintenance activities or other repairs shall be documented.
- k) All inspection and maintenance activities or other repairs shall be documented. The SWMP and documentation shall be kept on the Project site at all times.
- l) Modify the site map with arrows to indicate direction of surface and storm water flowing across the Project site.
- m) When adding or revising BMPs in the SWMP, amend the narrative to explain what, when, where, why, and how the BMP is being used, and add a detail to the SWMP.
- n) If using existing topography, vegetation, etc. as a BMP, label it as such in the SWMP site map; amend the Narrative to explain when, why, and how the BMP is being used to the SWMP.
- o) Record on the SWMP, and implement the approved plan for concrete and asphalt saw cutting, grinding, and milling containment and removal.
- p) Update the potential pollutants list in the SWMP throughout construction meeting CASDP requirements.
- q) Spills, leaks, or overflows that result in the discharge of pollutants shall be documented on the inspection form. The ECS shall record the time and date, weather conditions, reasons for spill, and how it was remediated. The ECS shall immediately report to the Contractor and Construction Project Manager the following instances of noncompliance:
- i. Noncompliance which may endanger health or environment.

- ii. Spills or discharge of hazardous substance or oil which may cause pollution of the City MS4 or State Waters.
  - iii. Discharge of stormwater which may cause an exceedance of a water quality standard.
- r) Perform a thorough inspection of the stormwater management system at least every seven (7) days and within 24 hours after any precipitation or snowmelt event with the potential to cause surface erosion. The inspection records shall be kept on-site in a written or previously approved format. Inspections shall be conducted during the progress of the work, during work suspensions, or until Final Stabilization of all disturbed areas is approved by Permit Enforcement Authority and shall include the following services at a minimum:
- i. The construction site perimeter, disturbed areas, and areas used for material storage that are exposed to precipitation shall be inspected for evidence of, or the potential for, pollutants entering the drainage system. BMPs identified in the SWMP shall be observed to ensure that they are operating correctly.
  - ii. The description of potential pollutant sources, and the BMPs identified in the SWMP, shall be revised and modified as appropriate based on the results of the inspection as soon as practicable after such inspection. Modification to the SWMP shall be implemented in a timely manner and in accordance with applicable Permit requirements.
  - iii. The operator shall keep a record of inspections. Uncontrolled releases of sediment or polluted storm water or measurable quantities of sediment found off the site shall be recorded with a brief explanation as to the measures taken to prevent future releases as well as any measures taken to clean up the sediment that has left the site. Inspection records shall be made available to the City upon request. Note: documentation of uncontrolled releases at site DOES NOT alleviate any State or Federal requirements for reporting of discharges or upset conditions. Care should be taken to ensure compliance with all regulatory requirements at site.
  - iv. Seven (7) day inspections are required during construction and at all times until Final Stabilization has been achieved. Seeding and mulching of disturbed areas does NOT count as final stabilization until such time as 70% pre disturbed vegetative cover has been achieved. Sites with growth in place sufficient to deter erosion that have not yet achieved final stabilization may petition the City to grant an alternative inspection schedule while awaiting additional growth for final stabilization. These inspections must be conducted in accordance with the above paragraphs.

#### **23.0.5.5 Applying BMPs**

The duration of the exposure of uncompleted construction to the effects of weather shall be as short as practicable. BMPs such as: seeding, surface roughening, mulching, applying

tackifier, use of geotextiles and matting, permanent landscaping, or other selected BMPs shall be applied within fourteen (14) calendar days of completion of grading/soil disturbance activities to stabilize the construction site unless disturbed area is within 100 feet of an MS4 or State Waters or has slopes of 3 to 1 or greater in which case BMPs shall be implemented within seven (7) calendar days of completion of grading activities. Disturbed areas where work is temporarily halted shall be temporarily stabilized within seven (7) days after the activity ceased unless work is to be resumed within thirty (30) calendar days after the activity ceased.

Clearing and grubbing operations shall be scheduled and performed to minimize both the area of the Project disturbed at a given time and the amount of time that disturbed areas remain open. BMPs such as temporary seeding are required between successive construction stages when disturbed areas will not be stable or active for thirty (30) calendar days or more. No payment will be made for additional work required because the Contractor has failed to properly coordinate the BMP schedule, thus causing previously stabilized areas to be disturbed by operations that could have been performed prior to the stabilization. Upon failure of the Contractor to coordinate the permanent BMPs with the grading operations in a manner to effectively control erosion and prevent water pollution, the Permit Enforcement Authority can suspend the Contractor's grading operations and the Construction Project Manager can withhold monies due to the Contractor on current estimates until such time that all aspects of the work are coordinated in an acceptable manner.

#### **23.0.5.6 Work Outside Limits of Construction**

Non-contiguous areas outside the limits of construction that are used by the Contractor that include, but are not limited to, borrow pits, haul routes, storage and disposal areas, field offices, maintenance, batching areas, etc., shall have appropriate BMPs implemented by the Contractor at the Contractor's expense. Should said areas meet applicable CASDP Permit criteria, the Contractor shall obtain a separate CASDP for each area as applicable at no additional expense to the City.

#### **23.0.5.7 Maintenance**

The Contractor shall continuously maintain erosion and sediment control BMPs on a daily basis or as directed by the ECS so that they function properly during and after construction (including work suspensions) until Final Stabilization has been approved by the Permit Enforcement Authority. Maintenance includes, but is not limited to, the following items:

- a) From the time seeding and mulching work begins until the date the Project has reached Substantial Completion of Erosion Control, the Contractor shall keep all seeded areas stabilized at all times. Any damage to seeded areas or to mulch materials shall be promptly repaired.
- b) All inspection sediment removal, and BMP maintenance activities to comply with all Federal, State & Local erosion control permit requirements until Final Stabilization is reached.

- c) All removal and replacement of existing BMPs due to damage to same suffered either by the contractor, outside agencies, the public, or acts of God.
- d) All required mechanical and/ or manual street sweeping.
- e) Discretionary changes required of any regulatory enforcement officer.

If the Contractor fails to maintain the BMPs in accordance with the Contract, or as directed, the City may at the expiration of a period of 48 hours, after having given the Contractor written notice, proceed to maintain BMPs as deemed necessary. The cost thereof will be deducted from any compensation due, or which may become due to the Contractor under this Contract.

#### **23.0.5.8 Minor SWMP Modifications**

These shall be made in the field by the Contractor and thoroughly documented in the Contractor's SWMP narrative and drawings. Should the Permit Enforcement Authority deem minor field modifications inadequate, the Contractor may be required to a) make specific modifications as requested by the Permit Enforcement Authority or b) return to the original approved design specifications. Minor SWMP Modifications are allowed, covered under the original CASDP, and required as part of standard maintenance and operation.

#### **23.0.5.9 Major SWMP Modifications**

The City reserves the right to require changes in the Work or Project Limits that may require a Major Modification to the SWMP and/ or CASDP due to unforeseen circumstances. Should this occur, the Contractor will be responsible for the following (as applicable):

- a) Make required revisions to comply with changing federal or state rulemaking if occurs within timeframe of Project
- b) Make required revisions due to unforeseen or unplanned conditions leading to deficient Drawings/ SWMP (hazardous materials encountered, landfills, expansion of work limits, etc.)
- c) Prepare revised SWMP elements endorsed by a Professional Engineer licensed in the State of Colorado.

#### **23.0.5.10 Substantial Completion of Erosion Control**

When a CASDP is required for the Project, Substantial Completion of the Project as defined by the City and County of Denver General Contract Conditions cannot be reached until Substantial Completion of Erosion Control has been granted. Granting of Substantial Completion of Erosion Control must be requested by the Contractor and be approved by the Permit Enforcement Authority in the form of a "Certificate of Substantial Completion of Erosion Control".

#### **23.0.5.11 Final Stabilization**

Granting of Final Stabilization must be requested by the Contractor and be approved by the Permit Enforcement Authority. Other permanent soil stabilization techniques may be proposed, in writing, by the Contractor and used upon approval, in writing, by the Construction Project Manager and Permit Enforcement Authority.

The Contractor may reach Final Stabilization via the following procedures:

- a) The Contractor shall file Inactivation Request for Construction Activities Stormwater Discharge Permit (available within CASDP guidance documents) with the Permit Enforcement Authority.
- b) The Contractor shall coordinate with the Permit Enforcement Authority to hold a Final Inactivation Inspection.
- c) If passing, the Permit Enforcement Authority transmits a letter of approval for Final Stabilization.
- d) If not passing, the Permit Enforcement Authority transmits a letter of denial for Final Stabilization with associated inspection report to Contractor.
- e) Stabilization, inspection and maintenance requirements shall continue until confirmation of having met final closure requirements have been granted in writing by the Permit Enforcement Authority. When Final Stabilization has been reached, the Permit Enforcement Authority shall issue a "Certificate of Final Stabilization".

#### **23.0.5.12 Final Acceptance**

CASDP obligations (including reaching Final Stabilization) may hinder the ability to reach Final Acceptance for the overall Project as defined in the City General Contract Conditions.

#### **23.0.6 Construction of BMPs**

BMPs shall be constructed so that they conform to all requirements as set forth within the Project SWMP. They shall meet all requirements set forth within each BMP detail and shall be installed and maintained so that they function in an effective and operable manner.

**End of Specification**



CITY AND COUNTY OF DENVER  
ENGINEERING DIVISION

## Wastewater Capital Projects Management Standard Construction Specification

---

### 25.0 Hot Mix Asphalt Pavement

#### 25.1 Design Intent

These specifications include general requirements applicable to all types of plant mixed hot mix asphalt pavements (HMAP). This work consists of one or more courses of asphalt mixture constructed on a prepared foundation in accordance with specifications. The design intent is to provide pavement with adequate thickness and quality to provide a service life of 20 years. It is also the intent to provide construction in accordance with these specifications and with a high standard of practice. This item shall include all labor, equipment, and materials to manufacture, place and compact asphalt cement concrete for pavement purposes.

TEST PROCEDURE DEFINITIONS	
CP-##	Colorado Department of Transportation: Field Materials Manual (Colorado Testing Procedures)
ASTM	American Society for Testing & Materials
AASHTO	American Association of State Highway & Transportation Officials
CP-L #####	Colorado Department of Transportation: Laboratory Manual of Test Procedures (Lab Testing Procedures)

#### 25.2 Materials

The hot mix asphalt shall be composed of a mixture of aggregate, filler, hydrated lime and asphalt cement. Some mixes may require polymer modified asphalt cement. Some mixes may allow up to 25% reclaimed asphalt pavement (RAP). All RAP shall meet the requirements of section 25.2.5

---



### 25.2.1 Aggregate

Aggregates for HMAP shall be of uniform quality, composed of clean, hard, durable particles of crushed stone, crushed gravel, or crushed slag. Excess of fine material shall be wasted before crushing. The material shall not contain clay balls, vegetable matter, or other deleterious substances and shall meet the requirements in Table 25.2.1.1.

**Table 25.2.1.1  
Aggregate Requirements**

Aggregate Test Property	Coarse: Retained on #4	Fine: Passing the #4
Fine Aggregate Angularity, CP-L 5113 Method A or AASHTO T 304 Note: Fine aggregate angularity does not apply to RAP aggregates		45% Min
Two Fractured Faces, CP-45 or ASTM D 5821  SG Mixtures Top and Middle Lifts Bottom Lifts SMA Mixtures	90% Min. 80% Min. 70% Min. 100% required	
LA Abrasion, AASHTO T 96	45% Max.	
Flat and Elongated (Ratio 5:1) %, AASHTO M 283	10% Max.	
Adherent Coating (Dry Sieving) ASTM D 5711	0.5% Max.	
Sand Equivalent. AASHTO-T 176		45% Min.
Micro Deval CP-L 4211 or AASHTO T 327	18% Max	

Reclaimed Asphalt Pavement material (RAP) shall be used only where specifically allowed as shown on the plans and shall be of uniform quality and gradation with a maximum size no greater than the nominal aggregate size of the mix. Mixes shall not contain more than 25 percent RAP.

The HMAP gradation for the proposed design job mix gradation shall be wholly within the control point gradation range set forth in Table 25.2.1.2. The allowable job mix gradation for production shall be the design job mix gradation with the tolerances of Section 25.13.2 applied. The proposed design job mix and the final allowable job mix gradation for production shall report all sieve sizes listed in table 25.2.1.2

**Table 25.2.1.2**  
**Dense Graded HMA Gradation Range**  
**(Percent by Weight Passing Square Mesh Sieves, CP-31, AASHTO 11 & T27)**

Mixture Grading	SX (1/2" nominal)		S (3/4" nominal)		SG (1" nominal)	
	Control Points	Caution Zone*	Control Points	Caution Zone*	Control Points	Caution Zone*
1 1/2"					100	
1"			100		90-100	
3/4"	100		90-100		@	
1/2"	90-100		@		@	
3/8"	@		@		@	
#4	@		@		@	39.5
#8	28-58	39.1	23-49	34.6	19-45	26.8-30.8
#16	@	25.6-31.6	@	22.3-28.3	@	18.1-24.1
#30	@	19.1-23.1	@	16.7-20.7	@	13.6-17.6
#50	@	15.5	@	13.7	@	11.4
#200**	2.0-8.0		2.0-7.0		1.0-7.0	

\* The caution zone is guideline only. It is recommended that mix design gradations go above the caution zone boundaries, on the "fine" side

\*\* These limits shall include the weight of lime at 1.0%

@ These sieve sizes used only to determine the final Allowable Job Mix Formula (JMF) in accordance with 25.13.

### 25.2.2 Performance Graded Asphalt Binders

The Contractor shall provide to the Construction Project Manager acceptable 'Certifications of Compliance' of each applicable asphalt binder grade from the supplier. Upon non-conformance with specifications, the asphalt binder may be rejected as directed by the Construction Project Manager. When production begins the Contractor shall, upon request, provide to the Construction Project Manager a one quart can of each specified asphalt binder. Additionally, when requested, the Contractor shall provide the refinery test results that pertain to the asphalt binders used during production.

Asphalt binder shall meet the requirements of the Superpave Performance-Graded Binders (PG) as presented in table 25.2.2

**TABLE 25.2.2. -PROPERTIES OF PERFORMANCE GRADED BINDERS**

<b>Usage for each Binder Grade</b>	<b>PG 58-28</b>	<b>PG 64-22</b>	<b>PG 76-28</b>
Traffic Loading, Total 18 kip ESALs Over Design Life (Usually 20 Years)***	Low Volume (0-100,000)	100,000 to <10.0 Million	3.0 Million to <10 Million
Superpave Compactor Design gyrations Recommended (alternate) Usage	$N_{design} = 50$ (75)	$N_{design} = 75$ (100)	$N_{design} = 100$
<b>Property of Binder Grade</b>	<b>PG 58-28</b>	<b>PG 64-22</b>	<b>PG 76-28</b>
Flash Point Temperature, °C, AASHTO T 48	230 Min.	230 Min.	230 Min.
Viscosity at 135 °C, Pas, ASTM D 4402	3 Max.	3 Max.	3 Max.
Dynamic Shear, Temperature °C, where $C^*/\sin \delta @ 10 \text{ rad/sec.} \geq 1.00 \text{ Kpa}$ , AASHTO TP 5	58 ° C	64 ° C	76 ° C
<b>Rolling Thin Film Oven Residue Properties, AASHTO T 240</b>			
Mass Loss, %, AASHTO T 240	1.00 Max.	1.00 Max.	1.00 Max.
Dynamic Shear, Temperature °C, where $G^*/\sin \delta @ 10 \text{ rad/sec.} \geq 2.20 \text{ Kpa}$ , AASHTO TP 5	58 ° C	64 ° C	76 ° C
Elastic Recovery <sup>1</sup> , 25°C, % Min.*	N/A	N/A	50 Min.
<b>TABLE 25.2.2. -PROPERTIES OF PERFORMANCE GRADED BINDERS continued</b>			
<b>Pressure Aging Vessel Residue Properties, Aging Temperature 100 °C AASHTO PP1</b>			
Dynamic Shear, Temperature °C, where $G^*/\sin \delta @ 10 \text{ rad/sec.} \leq 5,000 \text{ Kpa}$ , AASHTO TP 5	19 ° C	25 ° C	28 ° C
Creep Stiffness, @ 60 sec. Test Temperature in °C,	-18 ° C	-12 ° C	-18 ° C

AASHTO TP 1			
S, Mpa, AASHTO TP 1	300 Max.	300 Max.	300 Max.
m-value, AASHTO TP 1	0.300 Min.	0.300 Min.	0.300 Min.
**Direct Tension Temperature in °C, @ 1.0 mm/min., Where Failure Strain >1.0%, AASHTO TP 3	-18 °C	-12 °C	-18 °C

\* Elastic Recovery by Task Force 31, Appendix B Method

\*\* Direct tension measurements are required when needed to show conformance to AASHTO MP.1

\*\*\* Project Design Engineer is to determine PG Binder

### 25.2.3 Additives – Hydrated Lime

Lime shall be added at the rate of 1% by dry weight of the aggregate and shall be included in the amount of material passing the No. 200 sieve. Hydrated lime for aggregate pretreatment shall conform to the requirements of ASTM C 207, Type N. In addition, the residue retained on a 200-mesh sieve shall not exceed 10% when determined in accordance with ASTM C 110. Drying of the residue in an atmosphere free from carbon dioxide will not be required.

### 25.2.4 Tack Coat

The emulsified asphalt, for Tack Coat shall be CSS-1h or SS-1h and conform to AASHTO M208 or M140, respectively.

### 25.2.5 Reclaimed Asphalt Pavement

Reclaimed Asphalt Pavement (RAP) may be allowed in the HMA mixture by the **Project Design Engineer**. It shall be of uniform quality and gradation with a maximum size particle no greater than the maximum size allowed in the HMA mixture. HMA mixtures containing RAP shall meet the same gradation requirements as a virgin HMA mix. The Project Design Engineer may allow mixtures with a maximum of 20% RAP may be allowed in the top lift of any asphalt pavement, and a maximum of 25% RAP may be allowed in layers below the top lift, RAP is not allowed in Stone Mastic Asphalt Mixtures, except by agreement by the **Project Design Engineer**.

The reclaimed asphalt pavement shall meet all the requirements for HMA pavement, as contained herein. The **General Contractor** shall have an approved mix design for the amount of RAP to be used prior to placement.

The **Construction Project Manager** may require the **General Contractor** to maintain separate stockpiles for each type of RAP material. All processed material shall be free of foreign materials and segregation shall be minimized. Any RAP material that cannot be readily broken down in the mixing process, and/or affects the paving operation, shall be processed prior to mixing with the virgin material.

Fine Aggregate Angularity requirements shall not apply to any RAP aggregate. The RAP will not contain clay balls, vegetable matter, or other deleterious substances.

Verification testing for asphalt content and gradation will be performed on RAP at the frequencies listed in section 25.5.2, below. The **Construction Project Manager** may request the mix supplier's testing results on RAP at any time. In addition, the mixture shall be tested for properties as listed in Table 25.15

**When the use RAP is allowed, the following additional conditions shall apply:**

25.2.5.1. The processed RAP must be 100 percent passing the 1¼" sieve. The aggregate obtained from the processed RAP shall be 100% passing the 1" sieve. The aggregate and binder obtained from the processed RAP shall be uniform in all the measured parameters in accordance with the following schedule:

**Table 25.2.5.1 RAP AGGREGATE UNIFORMITY TOLERANCES**

<u>Element</u>	<u>Uniformity*</u>
Binder Content	0.5
% Passing ¾"	4.0
% Passing ½"	4.0
% Passing 3/8"	4.0
% Passing #4	4.0
% Passing #8	4.0
% Passing #30	3.0
% Passing #200	1.5

\* Uniformity is the Maximum allowable Standard Deviation of test results of processed RAP.

25.2.5.2. The **General Contractor** shall have an **approved RAP Quality Control (QC) Plan** that details how the RAP will be processed and controlled. The QC plan must address the following:

25.2.5.2. A. RAP Processing Techniques. This requires a schematic diagram and narrative that explains the processing (crushing, screening, and rejecting) and stockpile operation for normal plant operation or a specific project.

25.2.5.2. B. Control of RAP Asphalt Binder Content: - Minimum Testing Frequency: 1/1,000 tons of processed RAP material (minimum 3 tests) for recent production of the mix type.

25.2.5.2. C. Control of RAP Gradation (CP31 or AASHTO T-30): Minimum Testing Frequency: 1/1,000 tons of processed RAP material (minimum 3 tests) for recent production of the mix type.

25.2.5.2. D. Process Control Charts shall be maintained for binder content and each screen listed, during addition of any RAP material to the stockpile. The **General Contractor** shall maintain separate control charts for each RAP stockpile. The control charts shall be displayed and shall be made available to the **Construction Project Manager** upon request.

### **25.2.5.3 Example of RAP QUALITY CONTROL PLAN**

**25.2.5.3. A** Initial quality control of the reclaimed asphalt pavement shall be performed prior to and during crushing. Material for reclamation shall be separated by quality and source before being accepted for processing. Reclaimed asphalt must be free of concrete, dirt and organic materials... These stockpiles shall be built from the ground up, completely mixing all loads as they come in.

**25.2.5.3. B** Crushing of the reclaimed asphalt pavement shall be accomplished by means of a cone crusher and a screen deck. Oversize material shall be to be rejected on a ¾" scalping material, which reprocesses the material through the cone additional times. The processed material shall be stockpiled at the crushing facility and kept in separate piles and separate from other products to prevent intermingling of products, as well as the feed bins to prevent intermingling of the aggregates.

**25.2.5.3. C** The reclaimed asphalt pavement material shall be sampled during the crushing operations according to AASHTO T 2 at frequencies greater than 1/1000 tons and tested for gradation and asphalt content in accordance with AASHTO T 27 AND T11, and AASHTO T 308. Testing shall be done randomly on a daily basis to ensure conformance to specifications.

**25.2.5.3. D** The reclaimed asphalt pavement material at the asphalt plant shall be again sampled and tested according to the appropriate procedures to ensure that the asphalt content and gradation meet specifications and represent

initial quality control data. Once data is collected, a statistical analysis shall be performed to determine the blend for the asphalt mixture design. This analysis shall be provided with the Asphalt Mixture Design submittal. The RAP will meet the Uniformity Specification of Table 25.2.5.1 above.

**25.2.5.3. E** The RAP system at the asphalt plant consists of a feed bin with a variable speed motor controlled by the plant computer, which ensures the proper quantity of RAP material called for by the mix design. Material is delivered to the asphalt-mixing chamber of the asphalt plant by means of conveyor belts. The RAP material falls from one conveyor to another through a shaker screen that serves to break up any RAP material that has recompacted. Any oversize material shall be rejected at the shaker screen. While in production, the front-end loader shall work the full face of the stockpile, to ensure a representative batch is being produced.

**25.2.5.3. F** Prior to starting a project and at any other time necessary, the RAP feed system shall be calibrated by placing an amount of RAP measured by certified external scales into the feed bin. That measured material is fed from the RAP bin across the belt scales. The weights are compared and, if outside of accepted tolerances for the blending system, adjustments are made by the plant-blending computer. This process is the same as for all other components of the mix design.

## 25.3 Mix Design and Plant Produced Mixture Requirements

The mix design materials shall be those listed in Section 25.2 and used for the project. No substitutions are allowed during production, unless approved by the **Construction Project Manager**.

The **Project Design Engineer** shall indicate on MGPEC Form #9 the project specific criteria concerning mix design method, traffic level, asphalt binder type, mixture grading, and maximum amount of RAP allowed. This information shall be provided on MGPEC Form #9, "Requirements for Hot Mix Asphalt (HMA)", or other Contract bidding documents. Grading SG (1-inch nominal aggregate) shall only be designed using the 150 mm Superpave molds. Hveem Stability and Lottman test are not required for Grading SG mixtures. Grading S and SX shall be designed using 100 mm Superpave molds.

### 25.3.1 Superpave Mixture Design Method

The **General Contractor** shall submit a Proposed Design Job Mix Formula (PDJMF) for each mixture required by the Contract. The mixture design shall be determined using AASHTO T-312 or Colorado Procedure CP-L 5115 for the Superpave Method of Mixture Design. Guidance is provided in "Superpave Level 1 Mix Design" SP-2 published by the Asphalt Institute. Mixture design and field control testing shall meet the following requirements of Table 25.3.1a (located on the following page) for Dense Graded HMA.

Mixture design and field control testing of SMA shall meet the following requirements of Table 25.3.1b.

This area is a blank space inserted for the purpose of keeping the table whole

**TABLE 25.3.1a SUPERPAVE MIXTURE PROPERTIES FOR DENSE GRADED HMA**

Property or Test	Traffic Levels (ESALs)		
Traffic Loading, Total 18 kip ESALs Over Design Life (Usually 20 Years)	Low (0-100,000)	Medium (100,000 to <3.0 Million)	High (3.0 Million to <30 Million)
Design gyrations, $N_{design}$ (Air Void: 3.5% to 4.5%) (See Note 1,2)	50	75	100
Air Voids in Total Mix (VTM) CPL 5115 or AASHTO T 312	(See Note 1)	(See Note 1)	(See Note 1)
Hveem Stability CP-L 5106 or AASHTO T 246 (Grading S & SX only) (See Note 3)	N/A	28 Min.	30 Min.
Voids Filled with Asphalt (VFA), MS-2	70-80	65-78	65-75
Lottman, Tensile Strength Ratio, % Retained, CP-L 5109 or AASHTO T 283, Method B	80 Min.	80 Min.	80 Min.
Lottman, CP-L 5109 or AASHTO T 283 Dry Tensile Strength, psi	30 Min.	30 Min.	30 Min.
VMA %. CP-48 or AASHTO PP 19 (See notes 2,3,4)	Minimum VMA criteria applies to the mix design only (Table 25.2.1.2). The minimum VMA criteria shall be linearly interpolated based on actual air voids. See 25.13 for production tolerances		

Note 1: Select the target Job Mix Optimum Binder Content for HMA gradings as close to 4.0% air voids as possible (3.5% to 4.5% air voids).

VTM is also referred to as Pax in CPL 5115, and %Gmmx in T 312

Note 2: Maximum Theoretical Specific Gravity of mix by CP-51 or AASHTO T 209.

Note 3: Refer to Section 25.13 for production tolerances.



Note 4: VMA shall be based on tests of the Bulk Specific Gravity of the Compacted Mix (CP-L 5103 or AASHTO T 166) and Aggregate (AASHTO T 84 & T 85), and calculated according to CP-48 or AASHTO PP 19. All mixes shall meet the minimum VMA specified in Table 25.3.2, below.

**Table 25.3.1b SUPERPAVE MIXTURE PROPERTIES FOR OPEN GRADED SMA**

Property	Test Method	Value for SMA
Lab compaction (Revolutions) $N_{Design}$	CPL 5115 or AASHTO T 312	100
Air Voids, percent at: $N_{Design}$ (See Note 1)	AASHTO T 312	3.0 – 4.0
Hveem Stability	CP-L 5106 or AASHTO T 246	30 Min.
Accelerated Moisture Susceptibility, tensile strength Ratio, (Lottman)	CPL 5109 or AASHTO T 283, Method B	80 Min.
Dry Split Tensile Strength, psi	CPL 5109 or AASHTO T 283, Method B	30 Min.
Grade of Asphalt Binder	n/a	PG 76-28
Voids in the Mineral Aggregate (VMA) %, minimum (see note 2)	CP 48 or AASHTO PP 19	17
Draindown at Production Temperature	AASHTO T 305	0.3 maximum
$\% VCA_{MIX}$ (See Note 3)	AASHTO PP 41-02	Less than $VCA_{DRC}$ (See Note 4)

General Note: Copies of AASHTO PP 41-02 and MP 8-02 (for designing SMA mixes) can be obtained from the CDOT Region Materials or the Project Design Engineer

Note 1: Select the target Job Mix Optimum Binder Content for SMA grading at 3.0% to 4.0% air voids

Note 2: VMA shall be based on tests of the Bulk Specific Gravity of the Compacted Mix (CP-L 5103 or AASHTO T-166) and Aggregate (AASHTO T 84 & T 85), and calculated according to CP-48 or AASHTO PP 19. All mixes shall meet the minimum VMA specified in Table 25.3.2, below

Note 3: VCA = Voids in the Coarse Aggregate

Note 4: DRC = Dry-Rodded Condition

**TABLE 25.3.2 MINIMUM VOIDS IN MINERAL AGGREGATE (VMA) for Dense Graded HMA & Open Graded SMA, %**

Nominal Maximum* Particle Size	Air Voids ++		
	3.5%	4.0%	4.5%
1"	12.2	12.7	13.2
¾"	13.2	13.7	14.2
½"	14.2	14.7	15.2
SMA	17.0	17.0	17.0

\* Nominal Maximum Particle Size is defined as one sieve size larger than the first sieve to retain more than 10%, but shall not exceed the 100% passing size. The Nominal Maximum Particle Size can vary during mix production even when the 100% passing size is constant.

++ Minimum VMA criteria apply to the mix design only. The minimum VMA criteria shall be linearly interpolated based on actual air voids. See Section 25.13 for tolerances.

## 25.4 Mixture Design Submittals

### 25.4.1 General Requirements

The General Contractor shall submit all mixture designs, certificates, refinery reports, and laboratory data to the Construction Project Manager for approval at least 7 days before construction is to begin. The job mix formula may be rejected as directed by the Construction Project Manager on the basis of incompleteness, timeliness or changes in materials. Submittals shall be in a timely fashion such that rejection will not delay completion of the project.

Proposed Design Job Mix testing shall be performed in a materials laboratory under the direct supervision of; and shall be stamped and signed by a Professional Engineer licensed in the State of Colorado practicing in this field. In addition, the General Contractor shall submit as part of the Proposed Design Job Mix, documents to verify the following:

1. Source of materials.
2. Gradation, specific gravity, source and description of individual aggregates and the final blend.
3. Aggregate physical properties.
4. Source and Grade of the Performance Graded Binder (PG Binder)

5. Proposed Design Job Mix – aggregate and additive blending, final gradation shown on 0.45 power graph, optimum asphalt content.
6. Mixing and compaction temperatures used.
7. Mixture properties determined at a minimum of four asphalt contents and interpolated at optimum and graphs showing mixture properties versus asphalt content.

The Construction Project Manager reserves the right to test the General Contractor’s mix for each hot asphalt pavement grading utilizing materials actually produced and stockpiled. General Contractor shall provide a sufficient quantity of each aggregate, mineral filler, RAP, and additive for the required laboratory tests, if required by the Construction Project Manager.

The Contractor shall not place any materials without acceptance and approval of the Construction Project Manager.

**25.4.2 Change in source or grade**

Should a change in the source of Asphalt Cement (AC) or Lime occur, a one point verification test (at optimum asphalt content) of the mix must be performed to verify that the applicable Table 25.3.1a(Dense Graded HMA) or 25.3.1b (SMA) or 25.3.2 (VMA), is still met. If this testing shows noncompliance, a new design job mix shall be established before the new AC or Lime source is used. Any change in aggregate type or source will require a new mix design.

**25.4.3 Mix Production Verification**

Production verification shall occur prior to the start of the project. The production verification shall be performed by LABCAT Level C certified technicians with current Certification to verify the volumetric properties of the mix. If the mix has been produced for another project within the last 90 days, data from that project can be submitted for this verification. Volumetric properties of the mix verification testing shall be within the following tolerances compared to the Proposed Design Job Mix. The mix verification test reports shall be submitted to the Construction Project Manager prior to mix placement.

**TABLE 25.4.3.1 MIX DESIGN VERIFICATION TOLERANCES**

Air Voids	+/- 1.2%
VMA	+/- 1.2%
Asphalt Binder Content	+/-0.3%
Stability	Applicable minimum

The tolerances in this table are for mix design verification only. See section 25.13 for production tolerances.

#### **25.4.4 Pre-paving Meeting**

The Construction Project Manager may require a pre-paving meeting of all parties involved in supply, haul, laydown inspection, quality control and quality acceptance of HMA. Areas of responsibility and contact names and numbers should be shared. A construction (joint) plan will be submitted at the pre-paving meeting, see section 25.9 for joint requirements. Form 25.1 provided at the end of this specification is an example of a pre-paving meeting agenda.

### **25.5 Equipment**

#### **25.5.1 Mixing Plant**

The mixing plant shall be capable of producing a uniform material, have adequate capacity, and be maintained in good mechanical condition. Defective parts shall be replaced or repaired immediately if they adversely affect the proper functioning of the plant or plant units, or adversely affect the quality of the hot bituminous plant mix.

Dust, smoke, or other contaminants shall be controlled at the plant site to meet all air quality requirements in the "Colorado Air Quality Control Act," Title 25, Article 7, CRS and regulations promulgated there under.

Acceptable safety equipment, approved by the Construction Project Manager, shall be provided by the General Contractor to accommodate sampling and testing.

#### **25.5.2 Hauling Equipment**

Trucks used for hauling HMAP shall have tight, clean, smooth metal beds thinly coated with a minimum amount of paraffin oil, lime solution, or other approved release agent. Petroleum distillates such as kerosene or fuel oil will not be permitted. Each truck shall have and use a cover of canvas or other suitable material to protect the mixture from the weather and excessive temperature loss or cooled layers of mix in truck.

#### **25.5.3 Bituminous Pavers**

Self-propelled pavers shall be provided for full lane width paving capable of spreading and finishing the HMA, material in full lane widths applicable to the typical section and thicknesses shown in the Contract and shall be equipped with:

1. anti-segregation devices,
2. A vibratory screed assembly capable of being heated.

Pavers used for shoulders, patching and similar construction, not requiring fine grade control, shall be capable of spreading and finishing courses of HMA material in widths shown in the Contract without segregation.

The paver's receiving hopper shall have sufficient capacity for a uniform spreading operation and shall have an automatic distribution system that will place and spread the mixture uniformly in front of the screed.

The paver shall be capable of operating at forward speeds consistent with uniform and continuous laying of the mixture. Stop and go operations of the paver shall be avoided. The screed or strike-off assembly shall produce the specified finished surface without tearing, shoving, or gouging the mixture. Self-propelled pavers shall be equipped with automatic screed controls with sensors capable of sensing grade from an outside reference line, and maintaining the screed at the specified longitudinal grade and transverse slope. The sensors may be contact or non-contact type devices. The sensor shall be constructed to operate from either or both sides of the paver and shall be capable of working with the following devices when they are required for the situation:

1. Grade control device at least 30 feet in length.
2. Joint matching device
3. Adequate length of control line and stakes, if no other type of geometric control is present
4. A straight edge at least 10 feet in length will be available to verify the crown on the screed, at the request of the Construction Project Manager

The controls shall be capable of maintaining the screed at the specified transverse slope within plus or minus 0.1 percent. Automatic mode should be used where possible. If the automatic controls fail or malfunction, the equipment may be operated manually for the remainder of the normal working day, provided specified results are obtained.

If the Contractor fails to obtain and maintain the specified surface tolerances, the paving operations shall be suspended until satisfactory corrections, repairs, or equipment replacements are made.

Placement of HMA on a waterproofed bridge deck shall be accomplished with equipment that will not damage the membrane or protective covering.

## **25.6 Manufacture**

### **25.6.1 Preparation of Aggregates**

Heating and drying of the aggregates shall be accomplished without damaging the aggregate. Lime shall be added to achieve complete and uniform coating of the aggregate. When hydrated lime is used it shall be added to the aggregate in accordance with one of the following methods:

- a. Lime Slurry Added to Aggregate: The hydrated lime shall be added to the aggregate in the form of a slurry and then thoroughly mixed in an approved pugmill. The slurry shall contain a minimum of 70 percent water by weight.
- b. Dry Lime Added to Wet Aggregate: The dry hydrated lime shall be added to wet aggregate (a minimum of three percent above saturated surface dry) and then thoroughly mixed in an approved pugmill.

The lime-aggregate mixture may be fed directly into the hot plant after mixing or it may be stockpiled for not more than 90 days before introduction into the plant for mixing with the asphalt cement. The hydrated lime may be added to different sized aggregates and stockpiled, by adding 75 percent of the lime to the aggregate passing the No. 4 sieve and 25 percent to the aggregate retained on the No. 4 sieve.

**25.6.2 Mixing**

The dried aggregates and asphalt cement shall be combined in the mixer in the quantities required to meet the design job mix. The materials shall be mixed until the aggregate is completely and uniformly coated, and the asphalt cement is uniformly distributed throughout the aggregate. The output rate shall not exceed the manufacturer’s capacity rating.

Baghouse fines shall be fed to the mixing plant in a uniform and continuous manner so as to maintain uniformity in the mixture. The Baghouse, fines feeder, auger, and related equipment, shall be in good working condition and operated in accordance with manufacturer’s recommendation. If the Construction Project Manager determines that non-uniform operation of the equipment is detrimental to the mixture, he may halt all construction until the General Contractor takes appropriate action.

The minimum temperature of the mixture when discharged from the mixer shall be as shown in the following table:

**Table 25.6.2.1  
Mixture Discharge Temperatures**

<b>Asphalt Grade</b>	<b>Minimum Discharge Temperature</b>	<b>Maximum Discharge Temperature</b>
PG 58-28	275° F	310° F
PG 64-22	290° F	325° F
PG 76-28*	318° F	326° F

\* Contractor or Binder supplier must supply production temperature as require by their product

The General Contractor may provide refinery information that recommends revised

discharge temperatures depending on the base binder grade or source being used. HMA mix shall be produced at the lowest temperature within the specified temperature range that produces a workable mix and provides for uniform coating of aggregates (95 percent minimum in accordance with AASHTO T 195), and that allows the required compaction to be achieved.

HMA mix may be stored provided that any and all characteristics of the mixture are not altered by such storage. If storing or holding of the mixture causes segregation, excessive heat loss, or adversely affects the quality of the finished product, corrective action shall be taken. Unsuitable mixture shall be disposed of at the **General Contractor's** expense.

When placing hot mix asphalt over bridge decks covered by waterproofing membrane, the minimum temperature of the mixture, when rolling operations begin, shall be 250 ° F. The job mix temperature may be increased up to 30 ° F to obtain this temperature.

The mineral filler for SMA shall be stored in a separate silo and added automatically in the correct proportion. The mineral filler addition equipment shall be electronically or mechanically interlocked to the aggregate feed sensors so that the proper amount of mineral filler is added whenever SMA is produced.

The SMA mineral filler shall be added at the same point the asphalt binder is added to the aggregate.

### **25.6.3 Hauling**

Each truck shall use covers (tarps) to protect the mix during transport. The Construction Project Manager can reject mix, which is hauled without a cover. Should the mixture show an excess or deficiency of asphalt cement, damage due to burning or overheating, an improper gradation, or thermal segregation with cold areas 10° F below the minimum discharge temperature, the truck shall be rejected.

### **25.7 Tack Coat**

Prior to placement of HMA, a tack coat shall be applied. The material shall be in accordance with 25.2.4. The emulsified asphalt shall be diluted 1:1 with water and applied at 0.10 ± 0.01 gallons per square yard of diluted material. The Construction Project Manager may direct other application rates to match the age or condition of the surface.

All work shall be done at locations and with the grade and quantities of material designated on the plans. The surface to receive the tack coat shall be dry and cleaned by sweeping or other approved method until dust, debris, and foreign matter are removed. The tack coat shall then be applied uniformly by squeegee, brooms, or distributor. Prior to placement of SMA, tack coat between the existing pavement and Stone Matrix Asphalt pavement shall be placed at a rate between 0.03 and 0.05 gallons per square yard

### **25.8 Placement**

Hot mix asphalt shall be placed only on approved, properly constructed surfaces that are



free from loose material, water, frost, snow or ice. The hot mix asphalt and tack coat shall be placed in accordance with the temperature limitations of Table 25.8 and only when weather conditions permit the pavement to be properly placed and finished as determined by the Construction Project Manager. Placement temperature as stated shall be increased by 5° F for each 10 miles per hour wind velocity to a maximum increased minimum placement temperature of 70° F.

**Table 25.8  
Placement Air and Surface Temperature Limitations**

Compacted Layer Thickness	Top Layer of Pavement*		Lower Layers*	
	PG 58-28 PG 64-22	PG 76-28	PG 58-28 PG 64-22	PG 76-28
<2 inches not permitted	N/A	N/A	N/A	N/A
2 inches to <3 inches	50° F	65° F	40° F	50° F
3 inches or more	50° F	60° F	40° F	40° F
SG mix only	N/A	N/A	38° F	38° F

\* Air temperature is taken in the shade. Surface temperature is taken on the subgrade or base. The Construction Project Manager may not waive the above temperature limitations for PG 76-28.

The mixture shall not be placed at a temperature lower than 245° F for mixes containing PG 58-28 or PG 64-22 asphalt, and 290° F for mixes containing polymer modified asphalt. Mix, which is too cold or damaged by weather, will be rejected.

The mixture shall be laid upon an approved surface, spread and struck off to obtain the required grade and elevation after compaction. The minimum lift thickness shall be **at least three times (preferably four times)** the normal particle size. The mixture shall be placed approximately 10-25 percent thicker than the existing surrounding mat thickness to account for compaction based on the materials being placed. Raking is not permitted and will not be allowed. Casting that causes any segregation will not be permitted.

On areas where the use of mechanical spreading and finishing equipment is impracticable, the mixture shall be carefully dumped, spread, raked, screeded, and luted by hand tools to the required compacted thickness plus 25 percent based on the materials being placed.. Carefully move or minimally work the HMA mix with the use of rakes, lutes, or shovels to avoid segregation. Mixtures made with modified asphalt cement require more rapid completion of handwork areas than for normal mixtures. Hauling and placement sequences shall be coordinated so that the paver is in constant motion. Starting and stopping shall not be allowed. A construction joint shall be placed at anytime the power stops, and the screed

drops enough to cause a surface dip in violation of Section 25.13.1, "Surface Tolerances"; or the mat temperature falls below that allowed in Section 25.12, "Compaction". Bituminous pavers shall be used to distribute the mixture either over the entire width or over such partial width as may be practicable. Echelon paving will be permitted.

If an unsatisfactory mix has been placed, it shall be removed, disposed of and replaced as directed. No compensation will be allowed for rejected material.

### **25.8.1 SMA PLACEMENT & Compaction**

A Roller Pass Study (RPS) for Density and 1000 foot demonstration control strip are required for placement of lifts less than or equal to 1.5 inch thick, optional for thicker lifts.

#### **25.8.1.A For Thin Lift SMA less than or equal to 1.5 inch thick.**

In-place density shall be determined through the completion of a Roller Pass Study (RPS) to be conducted during placement of the required 1000-foot demonstration control strip. The RPS will determine the necessary roller compaction process needed to produce a minimum pavement density of 94 percent of theoretical maximum density (RICE). During the RPS, a minimum of three sets of three 4-inch diameter cores each shall be taken to measure SMA mat density for the various sections of the RPS. All coring shall be completed by the **General Contractor** and submitted to the **Construction Project Manager**. The densities of the three cores will be averaged to produce the density for each RPS section tested.

Full production of the thin SMA shall not begin until density test results are determined and the project compaction process is established by the **General Contractor** and approved by the **Construction Project Manager**. The approved compaction process established from the RPS shall be used for the duration of the thin SMA paving. Changes to the thin SMA mixture will be reviewed and a new RPS may be required.

Using the same method for determining density during the RPS, density will be determined daily for each day of full production and tested to confirm pavement density. If a daily density check shows density below 92 percent of RICE, the **General Contractor** shall stop production and the **General Contractor** will again complete a RPS to establish the necessary compaction process. The **General Contractor** will be allowed two daily density checks below 92 percent of RICE to be addressed in this manner during the project. All subsequent daily checks that identify locations having density below 92 percent of RICE shall be removed and replaced and a new RPS shall be completed and approved prior to again beginning production. Thin SMA density requirements will be enforced when the SMA mix design gradation and specified lift thickness are in accordance with or exceed the 3:1 requirements for the ratio of nominal maximum aggregate size to lift thickness.

The **General Contractor** shall submit a plan for a Roller Pass Study (RPS) to the **Construction Project Manager** for approval. Upon approval by the **Construction Project Manager**, the **General Contractor** shall perform a RPS. The plan for the RPS shall include, but is not limited to the following:

Number, size, and type of rollers.  
Amplitude, frequency, size and speed of vibratory rollers.  
Temperature of mixture being compacted.  
Roller patterns.

The method of measuring density will be by roller passes. If a density element is based on a RPS, the Pay Factor shall be as shown in section 25.14.3.

**25.8.1.B For SMA lifts greater than 1.5 inch thick.**

If in the opinion of the **Construction Project Manager**, the roller pass study presented by the **General Contractor** is inadequate, then the **General Contractor** shall modify the compaction procedures as directed.

**25.8.1.C Before Proceeding with SMA placement,**

The General Contractor shall demonstrate the ability to produce and place a satisfactory mix.

The actual work may proceed when a full lane width demonstration control strip, having a minimum length of 1000 feet has been successfully placed. The **GENERAL CONTRACTOR** shall determine properties (Superpave Air voids, VMA, in-place density, and Hveem Stability) of the project produced mix that is used in the demonstration control strip and provide the results to the **Construction Project Manager**. No other SMA production or placement will be allowed until densities are determined. If the material in the demonstration control strip is not in close conformity with the specifications, the demonstration control strip will be removed and replaced at the **General Contractor's** expense. The **Construction Project Manager** will designate the location of the control strip.

SMA mixture shall be transported and placed on the roadway without drain-down or flushing. All flushed areas behind the paver shall be removed immediately upon discovery. If more than 50 square feet of flushed SMA pavement is ordered removed and replaced in any continuous 500 linear feet of paver width laydown, operations shall be discontinued until the source of the flushing has been found and corrected. The **Construction Project Manager** will designate the depth and area of all flushed areas requiring removal and replacement. All costs associated with the removal and replacement of the flushed areas shall be at the **General Contractor's** expense.

Stone Matrix Asphalt Pavement shall be placed and compacted in accordance with the temperatures listed in table 25.8 or as revised for the project.

The relative compaction for all SMA mixtures will be measured from roadway cores in accordance with CDOT-CP 44 or AASHTO T-166, Method B, unless the SMA mixture is being placed on a structure (bridge deck) in which case the **Construction Project Manager** may specify that nuclear gauge measurements be used.

When cores are used, the **General Contractor** shall provide all labor and equipment for the coring operation and filling the core holes. When nuclear density gauges are used, the tests will be performed in accordance with CDOT-CP 81 or ASTM D 2950 and CDOT-CP 82 or AASHTO T 230.

In-place density for SMA shall be  $95 \pm 2$  percent of the SMA Mix maximum specific gravity as measured according to Maximum theoretical value (Rice) (CDOT-CP 51 or AASHTO T 209).

## 25.9 Longitudinal Joints

### 25.9.1 Joint Placement

The longitudinal joints in both a new pavement and an overlay pavement layer shall offset the joint in the layer immediately below by 6 inches. The joints in any pavement layer shall not fall in a wheel track. The joints in the top layer of new pavement not built on top of an existing pavement shall be located on lane lines or as shown on the plans. Longitudinal joints shall be minimized, where feasible, with wide paving pulls or echelon paving. Joints shall be parallel to the flow of traffic and shall not cross any centerline, lane line, or edge line unless approved by the **Construction Project Manager**. The **General Contractor** shall submit, prior to paving, a joint plan and pavement marking plan showing locations and the methods to establish a field control line. The **Construction Project Manager** must approve such plans prior to paving. The **General Contractor** shall use a continuous string line to delineate longitudinal joints during paving as shown on the joint plan. All string lines shall be removed at the end of each day's paving.

The free edge of the paved pass shall be laid as straight as possible, to the satisfaction of the **Construction Project Manager**. This joint, if cold, shall be tack coated prior to placement of adjacent paving.

The new compacted mat shall overlap the previously placed mat no more than 1.5 inches. Excess overlap or thickness shall not be raked or cast onto the new mat, but shall be wasted by pulling back and removing. The hot edge shall be blocked or bumped in a smooth line consistent with the previous longitudinal edge. Minor raking will only be allowed to correct major grade problems or provide mix around manholes and meter covers. The longitudinal joint shall be rolled from the hot side and overlap the joint by approximately 6 inches on the cold side.

## 25.10 Transverse Joints

The **General Contractor** shall submit, prior to paving, a joint plan showing locations and the methods to be used to construct transverse joints. The **Construction Project Manager** must approve such plans prior to paving. Placing of the HMA shall be continuous with a minimum of transverse joints, and rollers shall not pass over the unprotected end of a freshly laid mixture. Transverse joints shall be formed by cutting back on the previous run to expose the full depth of the course. Tack coat material shall be applied to contact surfaces of all joints just before additional mixture is placed against the previously compacted material.

The end of transverse joints shall be located so they will be constructed with a full head of mix in front of the screed. When butt joints are constructed, runoff boards shall be used to support the roller on the downstream side of the joint. All tapered sections, rounded edges and segregated areas shall be removed to achieve a vertical face at the butt joint before paving is restarted.

When a temporary tapered joint is required for temporary traffic access, the ramp shall be removed back to a full depth section before paving is restarted.

When restarting paving operations, the paver screed shall be placed on the starter block on the completed side of the transverse joint. The starter block should be approximately 25% greater than the thickness of the existing completed mat, so that adequate grade and compaction can be achieved on starting the paving operation. The screed should be nulled (angle removed) when on starting blocks and an up angle of attack set. Proper head of mix should be introduced into the paver prior to starting. The new compacted (downstream) side of the joint may be up to 3/16 inches higher than the old (upstream) side. Raking of this joint shall not be allowed except to correct major grade problems. The surface tolerance at the transverse joint must be verified by the **General Contractor** with a 10-foot straight edge before the paver is more than 100 feet from the joint. If the surface tolerance is not within the 3/16", the **General Contractor** shall make corrections before proceeding

### 25.11 Segregation

The asphalt mixture shall be transported and placed on the roadway without segregation. All segregated areas shall be removed immediately and replaced with specification material before the initial rolling. If more than 50 square feet of segregated pavement is removed and replaced in any continuous 500 linear feet of paver width laydown, operations shall be discontinued until the source of the segregation has been determined and corrected.

The Construction Project Manager will visually determine areas, which are segregated, and may also use density and gradation measures to help in this determination. The Construction Project Manager will visually determine the extent of the segregation. The General Contractor will not be allowed additional compensation for correction of segregated areas.

### 25.12 Compaction

The temperature of the mixture immediately behind the screed shall be sufficient to allow for proper compaction of the HMA layer and at least 245 °F for PG 58-28 or PG 64-22 binder and between 297°F and 305 °F for PG 76-28 binder. The breakdown compaction should be completed as quickly as possible after placement occurs.

The HMA shall be compacted by rolling. The number, weight, and type of rollers furnished shall be sufficient to obtain the required density and surface texture while the mixture is in a workable condition. Compaction shall begin immediately after the mixture is placed and be continued until the required density is obtained. Final compaction shall be obtained using steel wheel rollers.

Pavement operations shall be suspended when density requirements are not met and the surface temperature falls below 185 °F, or there is obvious surface distress or breakage, the problem shall be resolved prior to continuing paving operations. The criteria for mixtures containing PG 76-28

asphalt cements shall be 235 °F. The minimum compaction temperatures may be adjusted according to the asphalt binder supplier recommendations. Adjusted minimum compaction temperatures must be shown on the approved mix design or on other asphalt binder supplier documents, and be available on the job site. Pay Reduction criteria in Section 25.14 shall still apply in such cases.

All roller marks shall be removed with the finish rolling. Use of vibratory rollers with the vibrator on will not be permitted on bridge decks.

The **General Contractor** shall establish a rolling pattern or procedure during the beginning of paving operations, which will achieve the required compaction and surface tolerances. This procedure may be re-evaluated by the **General Contractor** and **Construction Project Manager** throughout the paving operations.

All HMA paving shall be compacted to  $94.0 \pm 2$  percent of Maximum Theoretical (RICE) Density, (CP-51 or AASHTO T-209: Maximum Specific Gravity of Bituminous Paving Mixtures) as determined by ASTM D 2950. RICE values shall be used in calculating Relative Compaction according to CP-44 or AASHTO T 166. The **General Contractor** shall determine the proper RICE value to use for the initial day's placement. Subsequent day's RICE value(s) will be based on the current day's production. The **General Contractor** shall provide the producer's RICE value, which shall be used for production until the actual day's RICE value is determined by the testing firm of record for the project as approved by the **Construction Project Manager**.

All joints shall be compacted to  $92.0 \pm 2$  percent of RICE, taken fully on each side of joint, every 200 Linear Feet. RICE values shall be used in calculating Relative Compaction according to AASHTO T 166, Cores if need will be used to verify compaction results.

The **General Contractor** shall core the pavement, as required by the **Construction Project Manager**, for field density tests in accordance with Colorado Procedure 44 or AASHTO T 230, Method B, or for field calibration of nuclear density equipment in accordance with the ASTM D 2950 or Appendix of Colorado Procedure 81. At a minimum, cores for nuclear density equipment calibration shall be taken at the beginning of placement of each pavement layer or change of mixture materials or gradation. Untested areas during placement will also require cores to be taken to verify compaction.

Along forms, curbs, headers, walls, and all other places not accessible to the rollers, the mixture shall be thoroughly compacted with mechanical tampers.

Any mixture that becomes loose and broken, mixed with dirt, or is in any way defective, shall be immediately removed and replaced with fresh hot mixture and compacted to conform to the surrounding area.

Compaction requirements for SMA are covered in section 25.8.1. Rollers shall not be used in a vibratory mode on SMA unless they are first used successfully in the demonstration control strip. Pneumatic wheel rollers shall not be used on SMA Mix.

## 25.13 Production Tolerances

### 25.13.1 Top Lift Surface Tolerances

The variation between any two contacts with the surface shall not exceed 3/16 inch in 10 feet. For patching surface tolerances, the variation shall not exceed 3/8 inch in 10 feet. Irregularities exceeding the specified tolerance shall be corrected at the General Contractor's expense. Transverse measurements for variations shall exclude breaks in the crown sections.

### 25.13.2 Job Mix Formula Tolerances

Production test results that deviate from the design job mix by more than shown in the following table are subject to Section 25.14:

**Table 25.13.2.  
Gradation Tolerances**

Item	
Passing No. 3/8" and Larger (note 1)	± 6%
Passing No. 4 and No.8	± 5%
Passing No. 30 to No. 50	± 4%
Passing No. 200 (note 2)	± 2%
Air Voids	± 1.2%
VMA (note 4)	± 1.2%
Hveem Stability	(note 3)
Asphalt Content	± 0.3%

(Note 1) There is 1.0 percent tolerance for the maximum sieve size.

(Note 2) Mixes with passing No. 200 sieve material produced over 7.0 percent are allowed only when the above Air Voids and VMA tolerances are still met.

(Note 3) Hveem Stability must meet the minimum value specified in table 25.3.2.

(Note 4) When calculating VMA, use the most current aggregate specific gravity  $G_{sb}$ ,

When disagreements concerning determination of specification compliance occur, only valid tests from the Construction Project Manager will be considered. The Construction Project Manager shall determine validity. Generally, valid tests are those in which sampling and test have been performed according to referenced procedures and the results are within stated precision statements. When disagreements occur with Asphalt Content and gradation tests results, solvent extracted aggregate testing shall take precedence over burn off oven extracted aggregate, which shall take precedent over cold feed belt testing.

## 25.14 CONFORMITY WITH PLANS AND SPECIFICATION

### 25.14.1 General

---

All work performed and all materials furnished shall conform to the lines, grades, cross sections, dimensions, and material requirements, including tolerances, shown in the contract.

For those items of work where working tolerances are not specified, the **General Contractor** shall perform the work in a manner consistent with reasonable and customary manufacturing and construction practices.

When the **Construction Project Manager** determines that the material furnished, work performed, or the finished product is not in conformity with the contract and has resulted in inferior or unsatisfactory product, the finished product or materials shall be removed and replaced or otherwise corrected by, and at the expense of, the **General Contractor**.

Materials shall be sampled and tested by a qualified testing laboratory in accordance with the sampling, testing schedules, and procedures contained in the Section 25.15 Testing and Inspection. The approximate maximum quantity represented by each sample shall be as set forth in the testing schedule. An additional number of samples, in relation to the quantity of materials represented, may be selected and tested at the **Construction Project Manager's** discretion. The quantity represented by five consecutive random samples shall constitute a lot, whenever production schedules and material continuity permits. When it is necessary to represent short production runs, significant material changes, or other unusual characteristics of the work, the **Construction Project Manager** may establish a lot consisting of the quantity represented by any number of consecutive random samples from one to seven inclusive. Testing results that are determined to have sampling or testing errors, as determined by the **Construction Project Manager**, shall not be used.

## 25.15 Testing and Inspection

If any materials furnished or work performed by the **General Contractor** fails to fulfill the specification requirements, such deficiencies shall be reported to the **Construction Project Manager** and the **General Contractor** immediately. Preliminary written field reports of all tests taken and observation results shall be given to the **General Contractor** and **Construction Project Manager**, within 1 business day after samples were obtained or density testing performed. Field reports shall be forwarded to the Project Manager no later than 1 week following the testing.

Reports of all tests taken, including failing tests, shall be reported to the **Construction Project Manager** and to the **General Contractor** no later than 1 week following the sampling. Density test results will be given in writing at the time the testing occurs.

Testing of Hot Mix Asphalt Pavement shall be performed in accordance with Table 25.15. The tests shall be performed under the general supervision of and signed by a **Professional Engineer** registered in the State of Colorado. Laboratories shall be inspected by either AASHTO or accredited A2LA or equivalent in the elements listed below. Technicians taking samples and conducting compaction tests must have a LABCAT Level A certification or equivalent. Technicians conducting tests of asphalt content and gradation must have a LABCAT Level B certification or equivalent. Technicians performing volumetric testing must have a LABCAT Level C certification or equivalent.



**Table 25.15.1**  
**Schedule for Minimum Materials Sampling and Testing**

<b>Test</b>	<b>Standard*</b>	<b>Minimum Frequency</b>
Sampling	AASHTO T 168, ASTM D 979 and ASTM D3665	One test for each day
Density	AASHTO T 166, T 238, T 230 Or CP-44, CP-81, CP-82	One test for each 250 lineal feet per Lane
Thickness (Core)	ASTM D 3549	One test for each 1000 lineal feet per Lane,
Air Voids & VMA	AASHTO T 166 & AASHTO PP 19 or CP-48	One test for each day (See note 4, Table 25.13.2)
Gradation	AASHTO T 27, T 11 or CP-31A, CP-31B	One test for each day
Asphalt (AC) Content	AASHTO T 164 or CP-L 5120 or other methods agreed upon between <b>Construction Project Manager and General Contractor</b>	One test for each day
Maximum Theoretical Specific Gravity (Rice)	AASHTO T 209 or CP-51	One test for each day
Lottman Stripping, TSR & Dry Density	AASHTO T 283 or CP-L 5109, Method B	As requested by the <b>Construction Project Manager</b> .
Micro Deval	AASHTO T 327 or CP-L 4211	One per 5000 tons or 1 per project minimum

Construction Project Manager or designee shall be responsible for checking temperatures of mix in truck and on pavement, segregation, rolling patterns and other construction means and method that affect the performance of the pavement system. The General Contractor shall provide assistance in sampling and testing at all facilities and at the job site.

**End of Specification**

---



CITY AND COUNTY OF DENVER  
ENGINEERING DIVISION

## Wastewater Capital Projects Management Standard Construction Specification

---

### 26.0 Excavation and Embankment

#### 26.0.1 General

This work pertains to construction and consists of excavation, hauling, disposal, placement, and compaction of all material encountered on-site within the limits identified in the plans. All excavation and embankment for construction will be classified as “unclassified excavation” as hereafter described.

#### 26.0.2 Referenced Standards

AASHTO M 145	Classification of soils and soil-aggregate mixtures
AASHTO T 99	Moisture-Density Relations of Soils using a 5.5-lb Rammer and a 12-inch Drop
AASHTO T 180	Moisture-Density Relations of Soils using a 10-lb Rammer and a 18-inch Drop

#### 26.0.3 Excavation

*Unclassified Excavation.* Unclassified excavation shall consist of the excavation of all materials of whatever character required for the work, obtained within the construction project site, including surface boulders, masonry, organics, rocks, muck material, miscellaneous debris and slag that are not removed under some other item. The work also includes excavation for the ditches, channels, and placement, water and compaction of the material to construction embankments in accordance with the plans.

#### 26.0.4 Embankment

*Embankment:* Embankment material shall consist of approved material acquired from excavations, hauled and placed in embankments. Approval of the embankment material will be contingent on the material having a maximum dry density of not less than 90 pounds per cubic foot. Soil embankment shall consist of materials obtained on-site and approved by the Engineer.

## **26.0.5 Construction Requirements**

### **26.0.5.1 General**

The excavations and embankments shall be finished to a smooth and uniform surface conforming to the line and grade specified. Variation from the subgrade plan elevations specified shall not be more than 1.0 inch. Excavation operations shall be conducted so material outside of the slope limits will not be disturbed. Prior to beginning grading operations, all necessary clearing and grubbing and site demolition in that area shall be performed.

The Contractor shall notify the Engineer not less than ten working days prior to beginning excavation so the necessary cross sections may be taken. Baseline survey for purposes of payment of the unclassified excavation work item will be obtained by the CCD Survey Group. The baseline survey will be taken once all building and site demolition, including removal of the buildings, parking lots, driveways is complete. The baseline survey is intended to set the topography of the existing native soil below the pavements and building elevations. Once the construction is complete a second survey will be completed to determine the final quantity of unclassified excavation. The Contractor shall not excavate beyond the dimensions and elevations established.

### **26.0.5.2 Unclassified Excavation**

All material to be excavated shall be stockpiled as subgrade material or removed from the site. Materials excavated beneath the top twenty six (26) inches shall, at the discretion of the Engineer, either be placed in the subgrade stockpile or removed from the site and disposed of at Denver Arapahoe Disposal Site (DADS). It shall be the responsibility of the Contractor to determine the amount of subgrade material to be stockpiled and necessary for completion of the work. All stockpiled material not used shall be disposed of per Contract requirements.

### **26.0.5.3 Embankment**

Embankment construction shall include preparation of the areas upon which embankments are to be constructed, placing, moisture conditioning and compacting of approved material to the limits shown on the plans or as directed. Only approved materials shall be used in the construction of embankments and fills. The type of relative compaction required shall be a minimum of 95% of Standard Proctor density AASHTO T-99 within 2% of optimum moisture content.

The soil upon which the embankments are to be constructed shall be scarified to a depth of eight (8) inches and compacted with moisture and density control. The moisture content of the soil at the time of compaction shall be as specified or directed.

Embankment shall be placed in horizontal layers not to exceed six (6) inches loose measurement and shall be compacted as specified before the next layer is placed. Spreading equipment shall be used to obtain uniform thickness prior to compaction. As the compaction progresses, continuous mixing, leveling and manipulating shall be done to assure uniform moisture and density.

Embankments shall be constructed with moisture and density control. The moisture content of the soil at the time of compaction shall be as specified or directed. Maximum dry density of all soil types encountered or used will be determined in accordance with AASHTO T-99. The amount of water to be used in compacting A-2-6, A-2-7, A-4 and A-6 through A-7 soils shall not deviate from optimum on the dry side by more than two percentage points as determined by AASHTO T-99. A-4 soils, which are unstable at the above moisture content, shall be compacted at lower moisture content to the specified density.

Additional work involved in drying embankment material to the required moisture content shall be included in the work.

#### **26.0.6 Finished Grade**

Finished grade as shown on the plans or as directed shall be achieved by placement of a minimum of twelve (12) inches of compacted subgrade followed by placement of six (6) inches of topsoil. Materials, compaction, moisture and density requirements for the subgrade are as specified above.

**End of Specification**



CITY AND COUNTY OF DENVER  
ENGINEERING DIVISION

## Wastewater Capital Projects Management Standard Construction Specification

---

### **31-3223.12 Soil Improvement by Compaction Grouting**

#### **Part 1 - General**

##### **1.01 Introduction**

- A. Compaction grouting involves the injection under high pressure of a low-slump, mortar-like grout to compact and displace the adjacent soils. The grout does not penetrate soil pores but displaces the subsurface soils by forming a homogeneous grout bulb near the grout pipe tip.
- B. In situ soil types: Refer to the project specific geotechnical report for soil types.
- C. Applications: Loose fill stabilization; remediation of settling structures and utilities; sinkhole remediation; building/utility protection during tunneling; soil densification for site improvement; liquefaction mitigation. In certain cases, procedures can be designed to intentionally lift structures and/or utilities.

##### **1.02 Intent**

The intent of the compaction grouting specified herein is to provide soil improvement within the limits indicated on the Project Drawings to achieve the required degree of improvement detailed in these specifications.

##### **1.03 Standards and References**

- A. The most recent version of the following testing methods or standards shall be employed:
  1. ASTM D1586 Standard Penetration Testing (SPT) and Split-Barrel Sampling of Soils
  2. ASTM C1019 Sampling and Testing Grout
  3. ASTM C150/C150M Portland Cement
  4. ASTM C143/C143M Slump of Hydraulic-Cement Concrete

B. Reference documents as provided to the grouting contractor shall include:

1. This specification.
2. Construction Drawings.
3. Project specific geotechnical report.
4. Bid Documents.

## **1.04 Definitions**

A. *Compaction Grout*: A material blend of fine aggregate, fines and water to achieve a pumpable, thixotropic, viscous grout of a low slump to enable pumping at high pressure and remain intact after injection.

B. *Field Quality Control Representative (FQCR)*: The Contractor's representative given specific inspection tasks identified in this specification.

C. *Treated Zone* – the area requiring subgrade stabilization (compaction grouting) as measured between bedrock (or depth of refusal) and the subgrade of the facility to be supported

D. *Overburden/untreated zone* – the area as measured between the existing ground surface and the subgrade of the facility to be supported.

E. *Refusal* – **This definition relies on information provided by the approved contractor and is required as a submittal. In general Refusal is the point at which pipe advancement has stopped.** We agree that Refusal is based upon the physical limitations of the machine being used to advance the pipe. There is a point, based upon different mechanical limits, at which advancement ceases and may not be within the anticipated limits of bedrock.

F. *Geotechnical Data Report (GDR)* - A document that presents an interpretation of the known subsurface data for the project. The purpose of the GDR is to compile all geological, geotechnical, groundwater, and other data obtained from the geotechnical investigations for use by the various participants in the project. If available, this information will be included within the contract documents as specifically applicable to the project.

G. *Geotechnical Baseline Report (GBR)*- The intent of a GBR is to clearly and contractually define the geotechnical conditions through which tunneling will occur in order to evaluate a differing site condition (if encountered) and it is used as a basis of bid for the contractor. By assessing the anticipated geotechnical conditions for a project and providing baselines in the contract, the contractor has a basis from which to prepare their bid and select their means and methods. The baseline conditions do not necessarily reflect the actual conditions; they are not geotechnical fact to be encountered. Rather, they represent the owner's assumption of existing geotechnical conditions for the project. If available, this information will be included

within the contract documents as specifically applicable to the project. Regardless of inclusion, this information shall be investigated, interpreted, verified and/or developed by the contractor prior to commencement of the work.

### **1.05 SCOPE OF WORK**

A. The work shall consist of installation, monitoring and testing of compaction grouting within the limits indicated on the Drawings to meet the acceptance criteria presented in within these specifications.

B. In connection with the compaction grouting program, as shown on the drawings, the grouting contractor shall provide all labor, materials and equipment as detailed in the contract documents and within the Measurement and Payment to accomplish the work:

### **1.06 SUBMITTALS**

A. The following shall be submitted to the Construction Project Manager by the General Contractor a minimum of two (2) weeks *prior to the start of the work*:

1. A ground movement monitoring plan, as detailed in this specification, if structures are located within a horizontal distance equal to the depth of treatment.

2. A mix design for the project indicating sources and types of grout materials, with volumetric proportions, and field test data from previous projects indicating compressive strength and slump of 1 inch or less achieved. If the grouting contractor intends to deviate from the gradation provided in this specification, the contractor shall submit evidence of satisfactory use of the proposed material from past projects with similar geotechnical conditions.

3. Work procedures and control criteria (including volumes and pressures for each stage).

4. A general Work Procedures Plan outlining the spacing as shown on the Drawings, location, depth and estimated quantity of grout to achieve the specified criteria detailed in this specification. Grout hole locations shall be dimensionally referenced to the facility foundation as shown on the Drawings.

B. The following shall be submitted to the Construction Project Manager by the General Contractor *during construction*:

1. Accurate daily records of all grout pipe installation, compaction grouting quantities, including stage data, volume, pressure and depth for each grout pipe location.
2. Any change in the predetermined grouting program necessitated by a change in the subsurface conditions.

## **Part 2 – Equipment and Materials**

### **2.01 GROUTING EQUIPMENT**

- A. The grouting contractor shall supply equipment capable of advancing the grout pipe through overburden, soils and other obstructions to the specified depth or as is required to meet the project objectives.
- B. The grouting contractor shall supply all equipment required to operate a compaction grouting system capable of supplying the specified grout at variable flow rates and pressures, measured at the pump, up to 250 psi and at rates of 0.5 to 12 cubic feet per minute, as required to suit the application.
- C. The mixer shall be a continuous auger type to ensure complete uniform mixing of the materials used and shall be of sufficient capacity to continuously provide the pumping unit with mixed grout at its normal pumping range. The mixer must be capable of volumetrically proportioning the grout materials.
- D. The grouting contractor shall provide gauges or other instrumentation (measuring devices) to measure:
  - 1. Continuous grout pressure close to the top of the injection casing
  - 2. Flow rate of grout.
  - 3. Volume of grout injected.
- E. The grouting contractor shall supply and install structural monitoring equipment in accordance with these specifications.
- F. A communication system shall be maintained between the pumping and batching plant and the injection location. As an alternate, the grouting contractor may furnish a remote control system to allow full control (start, stop, flow rate, reversing) of the pump directly by the contractor's personnel from the injection point).

### **2.02 GROUT PIPES**

- A. Grout pipes and connections shall be steel casing of adequate strength to maintain the hole and to withstand the required jacking and pumping pressures. The pipes shall be at least 2.0 inches inside diameter in order to adequately handle the specified low slump material without plugging. All casing shall be flush joint threaded or a single piece tubing to provide a smooth inner wall and unobstructed inside diameter. It shall be the contractor's responsibility to install casing that does not detrimentally impact the grouting procedure.



- B. Pipes shall be installed such that grout material will not travel in the annular space between the pipe and adjacent ground and escape at the surface when pumped.

### **2.03 GROUT MATERIALS**

- A. Portland Cement (ASTM C150)
- B. Fine aggregate shall be sand with fines content (percent passing No. 200 sieve) of not less than 10 percent and not more than 30 percent. Natural fines may be supplemented with Fly/ash, a minimal amount of bentonite, or aggregate washings.
- C. Proportions of the mixture shall be as required to achieve a pumpable mix with not more than 1 inch slump.
- D. Upon discharge into the pump hopper or holding tank, the grout must be continuously agitated. Mixed grout may not be held in the agitator for more than 1.5 hours unless a set retarder, approved by the Owner's representative, is used.

## **Part 3 – Execution**

### **3.01 Site Examination**

- A. If adjacent buildings are involved, a building survey shall be performed.

### **3.02 Compaction Grouting**

- A. Compaction grouting shall be performed in accordance with the approved grout injection point layout scheme to achieve the following acceptance criteria in the in situ soil between the injection points:
  - 1. Post-grouting average, corrected Standard Penetration values exceeding 15 in typical site soils. Locations of the tests shall be agreed upon between the grouting contractor, Construction Project Manager and FQCR and will be spaced at no greater than 100 foot intervals. At each location, the Standard Penetration tests will begin at the approximate bottom of the facility to be supported and will be taken at 3 to 5-ft intervals in the treated zone.
- B. Compaction grouting shall extend from bedrock up to the subgrade of the facility to be supported.
- C. The grout shall be injected in stages until one of the following occurs:
  - 1. Grout flow ceases at a gauge pressure reading of 50 to 150 psi (250 psi maximum) or,
  - 2. Surface ground heave of 1 inch as measured via survey or,

3. An injected grout volume equal to approximately 2 to 6 cubic feet per 1 vertical linear foot of the material being treated.
- D. Compaction grouting shall be sequenced so that grouting does not take place within 4 feet of locations grouted within the previous 12 hours.
- E. As compaction grouting is completed at each location, the grouting contractor shall completely fill the grout hole to the ground surface with an approved granular material.
- F. Should the contractor reach refusal, at an elevation other than that which is expected, the FQCR shall notify the Construction Project Inspector immediately.

### **3.03 Field Quality Control**

The General Contractor's FQCR will ensure that procedures and documentation conform to these specifications.

- A. All compaction grouting shall be performed under the inspection of the FQCR.
- B. Monitoring and logging of compaction grouting operations for both test areas and production work shall be done by the grouting contractor and the FQCR.
- C. The FQCR will perform slump tests of grout and take measurements of grout mix quantities to verify the grouting contractor's grout mix, as follows:
  1. Slump tests will be performed a minimum of twice during each grout shift.
  2. Grout mix proportions will be checked a minimum of once daily.
- D. The FQCR will cast minimum size 2 inch by 4 inch grout test cylinders or 2 inch by 2 inch cube molds for strength testing (per ASTM C1019). One set of four cylinders or molds will be cast during each slump test.
- E. Layout of grout injection points shall be by the grouting contractor and checked by the FQCR and Project Inspector with survey control provided by the General Contractor.
- F. As detailed in this specification, daily records shall be maintained by the grouting contractor and submitted to the General Contractor on a daily basis.
- G. The grouting contractor shall monitor nearby structures as follows:
  1. A level control system will be installed by the contractor for each structure within a horizontal distance equal to the depth of treatment of the grouting operations.
  2. Monitoring shall be carried out on a continuing basis whenever compaction grouting is occurring within a horizontal distance equal to the depth of treatment.
  3. After completion of the compaction grouting program, the monitoring system and grout pipes will be removed and all holes will be filled with an approved material and the surface shall be restored to match existing materials.

As compaction grouting is completed at each location, the grouting contractor shall completely fill the grout hole to the ground surface with an approved granular material.

### **3.04 Testing and Inspection**

- A. The effectiveness of the proposed grouting layout scheme shall be verified as follows:
  - 1. The Contractor's FQCR shall perform the in situ Standard Penetration testing as directed by the Construction Project Manager. Two test sections will be performed before and during production work, as follows:
    - a. Test section locations will be agreed upon by the FQCR, Project Inspector and Grouting Contractor within the treatment area. A test section shall consist of a single module comprised of at least three grout injection points for isolated footings and sixteen grout injection points for area applications (such as along the alignment of the facility being supported). Tests will be performed at the center of the module prior to and after grouting. Standard Penetration tests will begin at the approximate bottom of the facility being supported and will be taken at 3 to 5-ft intervals in the treated zone below the facility being supported.
    - b. All testing to determine specification compliance will be provided by the FQCR. The same test method shall be utilized both before and after the soil improvement work in order to provide the most accurate assessment of the degree of improvement obtained.
    - c. The method of installation of the test section shall comply with this specification and shall be performed using the same grout line sizes, grout mix drilling and grouting equipment and procedures as that to be used for production work.
    - d. Prior to commencement of production grouting, two (2) test sections shall be performed. If the pre-production test sections indicate that the required ground improvement has not been achieved, the grouting contractor shall revise the Work Procedure Plan and re-test at two (2) test sections.
- B. Monitoring and logging of compaction grouting operations in the test areas and for production work shall be done by the grouting contractor and submitted to the FQCR on a daily basis.

**END OF SECTION**



CITY AND COUNTY OF DENVER  
ENGINEERING DIVISION

## Wastewater Capital Projects Management Standard Construction Specification

---

### **47.0 Construction Survey and Monumentation**

#### **47.0.1 Description**

The Contractor shall be responsible for construction surveying, calculating, and staking necessary for the construction of all elements of the project. The Contractor shall also provide locating, preserving, referencing, installing and restoring of land monuments based upon the project's Land Survey Control drawing(s) as provided in the Contract Documents. Unless otherwise noted, payment for construction surveying and monumentation shall be via separate bid items.

The work shall be done under the supervision of a Professional Land Surveyor (PLS) who is experienced and competent in storm sewer construction, sanitary sewer construction and roadway construction surveying and licensed in the State of Colorado.

The PLS shall be available to review work, resolve problems, and make decisions in a timely manner.

#### **47.0.2 Materials and Equipment**

The Contractor shall furnish all personnel, survey equipment, safety equipment, materials, and traffic control necessary to perform the required construction surveying and staking. If any survey equipment is found to be functioning outside the manufacturer's specified tolerance, certification from an approved repair facility showing that the instruments have been repaired, properly adjusted, or both if necessary shall be included in the survey records and submitted to the City Surveyor's Office before being used.

#### **47.0.3 Construction Requirements**

A Construction Survey Conference shall be held with the City Surveyor's Office prior to performing any surveying work under this section. The Contractor's Surveyor (PLS) and Party Chief shall attend. A Construction Survey Checklist shall be completed and signed by the City Surveyor's Office and the contractor.

The Contractor shall check and verify all established Primary horizontal and vertical control points.

All survey records generated shall be the property of the City and shall be available to the City Surveyor's Office for inspection or reproduction at all times. All survey records shall be transmitted to the City Surveyor's Office for inclusion into the project records before final project acceptance.

Electronic formats may be acceptable, please coordinate with the City Surveyor's Office.

## **Copies of any new Monument Records filed by the PLS with the State Board of Registration shall be submitted to the City Surveyor prior to filing.**

### **47.0.4 Construction Surveying**

The Contractor's PLS shall perform all construction surveying and staking that is necessary for construction of the project. Additionally, the contractor shall establish and maintain control points and stationing during construction to allow the City's Project Manager or designee a reference to determine contract pay quantities.

### **47.0.5 Staking**

It is the responsibility of the Contractor's PLS to adhere to industry standards and acceptable practices in regards to staking. Any re-staking will be the responsibility of the Contractor at no cost to the City.

### **47.0.6 Accuracy and Tolerances**

It is the responsibility of the Contractor's PLS to adhere to industry standards and applicable standards with regard to horizontal and vertical accuracy tolerances.

### **47.0.7 Responsibility and Inspections**

Supervision and coordination of construction surveying and staking is the Contractor's responsibility. The City Surveyor may inspect the Contractor's surveying; however such inspection will not relieve the Contractor of any responsibility for accuracy or completeness of work. The Contractor shall check the work to verify the accuracy and include documentation of this check in the Survey Records. All Contractor surveying inaccuracies, errors, or omissions shall be corrected at the Contractor's expense. The City Surveyor's inspection or the Contractor's corrections shall not entitle the Contractor to additional payment or contract time extension.

Survey control, benchmarks, and other significant stakes that are damaged, destroyed, or made inaccessible by the progress of construction shall be replaced, transferred or reestablished at the Contractor's expense.

### **47.0.8 Changes**

All changes in lines and grades required by the field conditions and all discrepancies in grades, alignments, locations or dimensions detected by the Contractor shall be immediately submitted to the City Project Manager in writing. No changes in given data or

plans will be allowed unless approved by the City Project Manager in writing. All changes shall be documented in the survey records.

#### **47.0.9 Traffic Control**

Traffic control necessary for surveying and monumentation work shall not be measured and paid for separately. All traffic control costs incurred due to this work shall be included within the associated bid item(s).

#### **47.0.10 Survey Records**

Survey records shall be completed as the work is done. Field survey notes for construction surveying and checking by the Contractor shall be recorded in survey records in conformance with industry standards and acceptable practices.

All survey records generated shall be the property of the City and shall be available to the City Surveyor's Office or the City Construction Project Manager for inspection or reproduction at all times. All survey records shall be transmitted to the City Surveyor's Office for inclusion into the project records before final project acceptance. All survey records shall be stamped with the seal of, and signed by, the responsible PLS.

"As-built" and "Red-lined" drawings and prints necessary for the construction and preparation of record drawings for all elements of the project shall be the responsibility of the Contractor.

All "As-built" and "Red-lined" drawings generated shall be the property of the City and shall be submitted to the Construction Project Manager upon completion. In addition to red-lined prints, the Contractor shall supply the Construction Project Manager with electronic survey data information in the form ".asc", ".txt", and/or ".dwg" files upon request.

#### **47.0.11 Survey Monumentation**

This work consists of locating, preserving, referencing, installing and restoring land monuments as indicated in the Land Survey Control drawing(s) for the specific contract. Survey Monumentation includes but is not limited to: City of Denver Range Points and accessories, Primary Control monuments from which the Right of Way or any land boundary will be calculated, described or monumented, Public Land Survey System (PLSS) monuments, Right of Way (ROW) monuments, General Land Office (GLO) monuments, Bureau of Land Management (BLM) monuments, Mineral Survey (MS) monuments, property boundary monuments and offsets, benchmarks, easement monuments, and other monuments that are required by law or regulation to be established and recorded by a Professional Land Surveyor (PLS).

At the close out of the project the following Survey documents shall be submitted to the City Surveyor for review and acceptance:

1. City and County of Denver Monument Tie Out Sheets for all range points within the project influence.
2. A survey of all project monumentation per State Statute.

The production of additional documentation may be required by the City Surveyors' Office. All such work included in this section shall be under the supervision of a PLS who is licensed in the State of Colorado.

#### **47.0.12 Reset Monuments**

Survey monuments, benchmarks, and other significant monuments that are damaged, destroyed, or made inaccessible by the progress of construction shall be replaced, transferred or reestablished at the Contractor's expense.

Locating, preserving, referencing, installing and restoring land monuments as described in this specification shall be done under the supervision of a PLS who is experienced and competent in Right of Way and boundary surveying and licensed in the State of Colorado

#### **47.0.13 Locating Monuments**

This work consists of field locating all survey monumentation as discussed in 47.0.11 which is in place within the project limits. A diligent search of construction zones and project limits shall be performed by the PLS.

#### **47.0.14 Preserving and Referencing Monuments**

All monuments as described in this specification shall be preserved, referenced and reset by the Contractor's PLS within the project limits.

#### **47.0.15 Installing Monuments**

All monuments as described in the contract documents shall be preserved through construction. If any monuments are to be disturbed/removed during construction, it will be the contractor's responsibility to have all monuments reset to current City of Denver standards. Appropriate documentation will be required for all reset monuments.

#### **47.0.16 Monument Box**

This survey work shall consist of installing or adjusting monument boxes to current City or State requirements.

#### **47.0.17 Method of Measurement**

All survey work will be paid for via the associated bid item(s) and in accordance with the respective Measurement and Payment portions of the Contract Documents.

**End of Specification**

CITY AND COUNTY OF DENVER  
STATE OF COLORADO



DEPARTMENT OF PUBLIC WORKS

Plans/Drawings

Contract Number: 201843656



General Sanitary – Cherry Creek Improvements

August 1, 2018



**CITY AND COUNTY OF DENVER**  
**DEPARTMENT OF PUBLIC WORKS**  
**ENGINEERING DIVISION - CAPITAL PROJECTS MANAGEMENT**  
**CHERRY CREEK EAST SANITARY IMPROVEMENTS**

SHEET INDEX	
SHEET NUMBER	SHEET TITLE
1	COVER SHEET
2-3	DETAILS AND NOTES
4	KEY MAP
5-32	SANITARY PLANS**

\*\*SEE KEY MAP, SHEET 4, FOR LOCATION OF SANITARY IMPROVEMENTS

LEGEND	
####SAGM XXX'-Y" VCP - Z.ZZ%	<b>SANITARY MAIN ID</b> LENGTH, SIZE, MATERIAL, AND SLOPE ABC =PROJECT PIPE NUMBER
(ABC)	
(S)	SANITARY MANHOLE
(S)	SANITARY MANHOLE NEAR GROUNDWATER*
	CHERRY CREEK EAST MAIN TO BE LINED
	EXISTING MAIN - REHABILITATED
	EXISTING MAIN - ALREADY LINED
	EXISTING MAIN - METRO LINE
	EXISTING MAIN - PRIVATE
	EXISTING MAIN - PRETREATMENT SERVICE LINE
	EXISTING MAIN - UNLINED SIZE AND MATERIAL AS SHOWN
	EXISTING SANITARY EASEMENT
	EXISTING SANITARY SERVICE LINE
	LOT/PARCEL LINE
	CITY BOUNDARY

\*GROUNDWATER ELEVATIONS (BASED ON CCD GIS INFORMATION) ARE NEAR OR ABOVE THE INVERT OF THESE MANHOLES. THIS IS PROVIDED FOR INFORMATION ONLY TO SHOW WHERE ACTIVE SUMP PUMPS COULD BE PREVALENT, BUT AREAS WHERE PUMPING OCCURS ARE ANTICIPATED TO VARY IN THE FIELD.

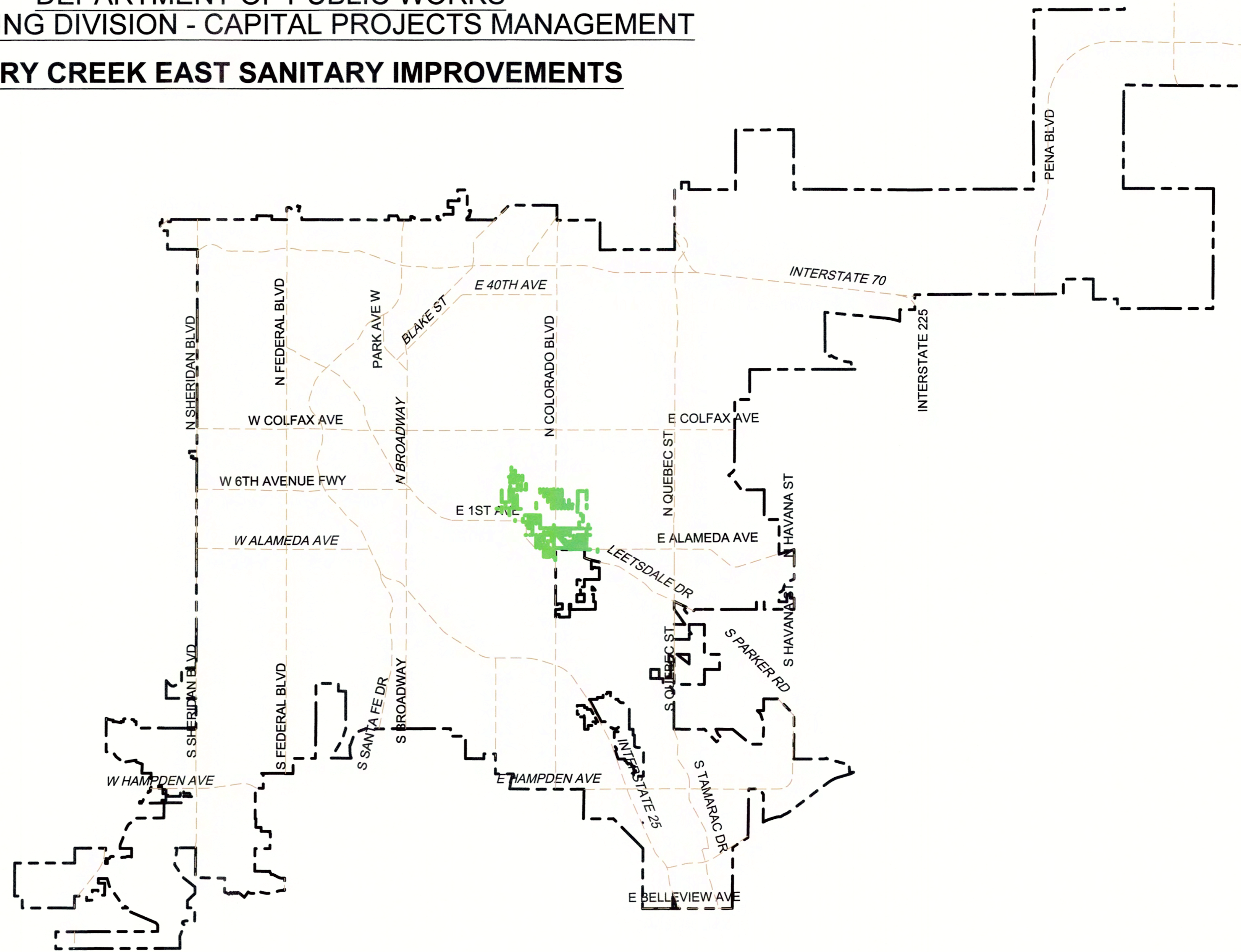

NO.	DESCRIPTION OF REVISIONS	DATE	BY

CALL UNCC  
TWO WORKING DAYS  
BEFORE YOU DIG  
1-800-922-1987  
uncc@denvergov.org

CITY AND COUNTY OF DENVER  
DEPARTMENT OF PUBLIC WORKS  
ENGINEERING DIVISION  
CAPITAL PROJECTS MANAGEMENT  
2000 W. 3RD AVE. DENVER, CO 80223  
TEL.: (303) 446-3617 FAX: (303) 446-3647

**CHERRY CREEK EAST SANITARY IMPROVEMENTS**  
PRO TRACKING NO: PWWW2018-001  
PROJECT MASTER NO: 2018-PROJMSTR-0000089  
COVER SHEET

APPROVED BY:	
	6/13/18
EXECUTIVE DIRECTOR OF PUBLIC WORKS	DATE
	6.8.18
CITY ENGINEER	DATE
	06/08/2018
DIRECTOR OF ENGINEERING CAPITAL PROJECTS	DATE
	06/07/2018
CITY TRAFFIC ENGINEER	DATE

DRAWN BY: CJM
DESIGNED BY: -
APPROVED BY: JJC
DRAWING NAME: COVER SHEET.dwg
DATE: 04/20/2018
SHEET NO.: 1 OF 32

**CONSTRUCTION NOTES:**

1. CONTRACTOR MUST COORDINATE WORK AROUND OTHER CONTRACTORS IN THE AREA AND SHALL AVOID CONFLICTS WITH ANY SPECIAL EVENT THAT MAY OCCUPY LANES OR OTHERWISE OCCUR IN THE ROW. SPECIAL ATTENTION AND COORDINATION WILL BE NECESSARY IN AND AROUND MILE HIGH STADIUM, COORS FIELD, PEPSI CENTER, AND NATIONAL WESTERN COMPLEX.
2. THE CONTRACTOR SHALL OBTAIN RIGHT-OF-WAY PERMITS AND PARKS PERMITS WHERE APPLICABLE FOR THIS CAPITAL PROJECT. ALLOW AT LEAST 5 WORKING DAYS FOR THE REVIEW AND ISSUING OF PERMITS FOR ARTERIAL AND COLLECTOR STREETS. CONTACT 303-446-3469. THE PERMIT, AS ISSUED, SHALL BE ON-SITE AT ALL TIMES THAT WORK IS ONGOING. TRAFFIC CONTROL PLANS (TCP'S) FOR THESE PERMIT REQUESTS SHALL SHOW ACTUAL SITE-SPECIFIC CONDITIONS TO MAINTAIN MINIMUM 11-FOOT TRAVEL LANES AND CLEARANCE AROUND EQUIPMENT AND MANHOLES LOCATIONS. EQUIPMENT AND MANHOLES SHALL BE CLEARLY INDICATED ON THE TCP. A TYPICAL TCP CAN BE APPLIED FOR RESIDENTIAL STREETS AND ALLEYS.
  - A) THE ARTERIAL AND COLLECTOR STREETS (STRIPED STREETS, OR THOSE SO DESIGNATED IN DENVER GIS SYSTEM) WILL NEED SITE-SPECIFIC MHTS THAT SHOW ALL EXISTING LANE CONFIGURATIONS AND ALL NEEDED TEMPORARY TRAFFIC CONTROL DEVICES. ALSO INCLUDE THE LOCAL STREETS IF THEY INTERSECT THE INVOLVED WORK AREAS.
  - B) THE LOCAL (USUALLY NON-STRIPED) STREETS (NON-ARTERIAL AND COLLECTOR STREETS) MAY USE TYPICAL MHTS, IF DESIRED.
3. DUE TO HIGH TRAFFIC VOLUMES AND OTHER FACTORS, THERE WILL BE SEVERAL LOCATIONS WHICH WILL REQUIRE A HIGH LEVEL OF CARE. TRAFFIC CONTROL SHALL INCLUDE, BUT IS NOT LIMITED TO: UNIFORM TRAFFIC CONTROL (UTC), NIGHT WORK, WEEKEND WORK. TRENCHING IN STREET TO BURY BYPASS LINE, ETC. THERE WILL BE NO ADDITIONAL COMPENSATION FOR THE ABOVE-MENTIONED ITEMS WHICH ARE REQUIRED BY THE PERMITTING AUTHORITY (CCD-ROWS) AND (CCD-TES), TO BE INCLUDED AS PART OF THE METHOD OF HANDLING TRAFFIC (MHT).
4. WORK SHALL BE COMPLETED WITHIN A NEIGHBORHOOD PRIOR TO RELOCATING TO ANOTHER NEIGHBORHOOD, UNLESS A MAIN OR MAINS HAVE BEEN DEEMED UN-LINEABLE AND HAVE BEEN SUBMITTED FOR AND IS AWAITING REPAIR (SEE NOTE 7). NUMBERING ON THE PLANS IS A RECOMMENDED ORDER OF LINING BUT MAY BE MODIFIED IN THE FIELD AS COORDINATED BETWEEN THE CONTRACTOR AND THE CONSTRUCTION PROJECT MANAGER.
5. SANITARY SEWER BYPASS PUMPING FOR PIPES 10-INCH DIAMETER AND SMALLER IS INCLUDED IN THE COST OF THE CIPP LINER AND WILL NOT BE PAID FOR SEPARATELY.
6. SANITARY SEWER BYPASS PUMPING FOR PIPES 12-INCH DIAMETER AND LARGER WILL BE PAID FOR WITH BID ITEMS: 34-17.3C, 34-17.3D, 34-17.3E, 34-17.3F, AND 34-17.3F-22.
7. WHEN A SECTION OF PIPE IS CONSIDERED TO BE "UN-LINABLE," THE INSPECTOR SHALL BE CONTACTED IMMEDIATELY SO THAT THE VIDEO CAN BE REVIEWED, AND A POINT REPAIR CAN BE INITIATED. AT LEAST THREE WEEKS SHALL BE ALLOWED FOR THE COMPLETION OF ANY POINT REPAIR. AFTER THE REPAIR IS COMPLETED, CCD WILL NOTIFY THE CONTRACTOR THAT THE SECTION IS READY TO BE PLACED ON THE LINING SCHEDULE.
8. A CDOT ACCESS PERMIT WILL BE REQUIRED FOR WORK IN INTERSTATE/US/STATE HIGHWAYS.
9. THE CONTRACTOR SHALL SUBMIT A WORK PLAN THAT LAYS OUT THE EXECUTION OF THE PROJECT FROM START-TO-FINISH. THE WORK PLAN SHALL INCLUDE, BUT IS NOT LIMITED TO SITE ACCESS, SITE PREPARATION, TRAFFIC CONTROL, BYPASS PUMPING, PRE-INSTALLATION PREPARATION, AND TESTING. INCLUDE FEE FOR SECURITY IN THE COST ESTIMATE AS DEEMED APPROPRIATE BY THE WORK PLAN.
10. GRINDING OF SANITARY MAINS IS TO BE QUANTIFIED IN THE FIELD BASED ON THE LENGTH AND DURATION OF GRINDING REQUIRED FOR EACH MAIN.
11. ALL R.O.W. STRUCTURES REMOVED OR DAMAGED WILL NEED TO BE REPLACED TO CCD STANDARDS.
12. ANY WORK OR STAGING ON PARK PROPERTY OR WITHIN THE CHERRY CREEK CORRIDOR WILL REQUIRE A PARK TCAP. RESTORATION WILL NEED TO FOLLOW PARK SPECIFICATIONS.
13. NO EXCAVATION OR LAND DISTURBANCE IS ANTICIPATED FOR THE PROPOSED SANITARY IMPROVEMENTS.
14. KNOWN UNDER-CONSTRUCTION DEVELOPMENTS ARE SHOWN ON THE PLANS, BUT OTHER PROJECTS MAY BE UNDERWAY SINCE THESE PLANS WERE APPROVED. COORDINATE CONSTRUCTION TIMING AND ACCESS WITH ADJACENT PROJECTS.
15. THIS PROJECT HAS POTENTIAL IMPACTS TO MANLEY PARK, CONGRESS PARK, PULASKI PARK, CRANMER PARK, BURNS PARK, E ALAMEDA PKWY AND E 6TH AVE PKWY. CONTACT ERICK ANDERSON AT 720-865-6975 TO COORDINATE PROJECT SCHEDULE AND WORK IN AND/OR ADJACENT THE AFOREMENTIONED PARKS AND PARKWAYS.
16. **LINING OPERATIONS FROM S SAINT PAUL STREET TO S MONROE STREET BETWEEN E 1ST AVENUE TO E 3RD AVENUE SHALL BE LIMITED MONDAY THROUGH THURSDAY. CLEANUP CAN BE PERFORMED ON FRIDAYS.**

**DENVER DEPARTMENT OF PUBLIC HEALTH AND ENVIRONMENT**

1. CONTRACTOR SHALL TAKE REASONABLE MEASURES TO PREVENT PARTICULATE MATTER FROM BECOMING AIRBORNE AND TO PREVENT THE VISIBLE DISCHARGE OF FUGITIVE PARTICULATE EMISSIONS BEYOND THE PROPERTY LINE FROM WHICH THE EMISSIONS ORIGINATE. THE MEASURES TAKEN MUST BE EFFECTIVE AT ALL TIMES ON THE SITE, INCLUDING PERIODS OF INACTIVITY SUCH AS EVENINGS, WEEKENDS, AND HOLIDAYS AS WELL AS ANY OTHER PERIOD OF INACTIVITY.
2. THE CONTRACTOR SHALL DIRECT NON-RECYCLABLE, NON-HAZARDOUS WASTES FROM CCD-OWNED OR CONTROLLED PROPERTY OR FACILITIES TO THE DENVER ARAPAHOE DISPOSAL SITE (DADS) LANDFILL FOR DISPOSAL, FOLLOWING THE REQUIREMENTS AND PROCEDURAL GUIDANCE PER CCD EXECUTIVE ORDER 115. LABORATORY ANALYTICAL RESULTS WILL BE REQUIRED PRIOR TO DADS ACCEPTANCE FOR SOIL AND POSSIBLY OTHER MATERIALS. EARLY TESTING IS RECOMMENDED; DDPHE CAN ASSIST. CONTACT DDPHE AT 720 865 5448 WITH QUESTIONS.
3. NOISE CONTROL. ALL NOISE CAUSED BY CONSTRUCTION OF, OR RESULTING FROM COMPLETED, PROJECTS, MUST COMPLY WITH DENVER'S NOISE ORDINANCE, D.R.M.C. CHAPTER 36 "NOISE CONTROL," EXEMPTED HOURS FOR CONSTRUCTION IN THE CITY AND COUNTY OF DENVER ARE FROM 7 A.M. TO 9 P.M. MONDAY THROUGH FRIDAY AND 8 A.M. TO 5 P.M. ON SATURDAYS AND SUNDAYS. IF THERE IS A NEED TO WORK OUTSIDE OF THE EXEMPTED HOURS: 1) THE CONTRACTOR MUST REQUEST A VARIANCE, AND 2) THE VARIANCE PROCESS NEEDS TO BE STARTED A MINIMUM OF THREE MONTHS PRIOR TO THE DESIRED START DATE. ANY QUESTIONS SHOULD BE DIRECTED TO PAUL RIEDESEL, DDPHE COMMUNITY NOISE PROGRAM, 720-865-5410.

**WASTEWATER CAPITAL PROJECT MANAGEMENT GENERAL NOTES**

1. CONTRACTORS PERFORMING WORK ON ANY WASTEWATER FACILITY OR APPURTENANCE MUST BE PROPERLY LICENSED AND HAVE A LICENSED PLUMBER OR DRAINLAYER ON SITE DURING THE WORK.
2. THE CURRENT EDITION OF THE WASTEWATER MANAGEMENT DIVISION STANDARD DETAILS SHALL APPLY TO ALL WORK AND WILL BE THE EDITION CURRENT AS OF THE ADVERTISEMENT DATE. THE CONTRACTOR MUST BE IN THE POSSESSION OF THE STANDARD DETAILS AT THE PRE-CONSTRUCTION CONFERENCE, AND A COPY MUST REMAIN ON THE JOB SITE AT ALL TIMES DURING CONSTRUCTION. WASTEWATER MANAGEMENT DIVISION STANDARD DETAILS CAN BE OBTAINED AT [WWW.DENVERGOV.ORG](http://WWW.DENVERGOV.ORG).
3. THE CONTRACT SPECIFIED EDITION OF THE CITY AND COUNTY OF DENVER'S TRANSPORTATION STANDARDS AND DETAILS FOR THE ENGINEERING DIVISION SHALL BE FOLLOWED FOR ALL ROADWAY WORK IN THE PLAN SET AND WILL BE THE EDITION CURRENT AS OF THE ADVERTISEMENT DATE. THESE STANDARDS AND DETAILS CAN BE OBTAINED AT [WWW.DENVERGOV.ORG](http://WWW.DENVERGOV.ORG). "ROADWAY" MEANS ALL "FEATURES IN THE CITY ROW" TO INCLUDE ANY RESTORATION TO SIDEWALKS, ADA RAMPS, FLATWORK AND STREET PAVING MUST FOLLOW THE CITY PW & WWM SPECS AND THE CURRENT APRIL 2017 TS&D.
4. THE CONSTRUCTION ACTIVITIES STORMWATER DISCHARGE PERMITS (STATE AND LOCAL FLOODPLAIN PERMITS), STREET-CUT PERMIT, AND STREET OCCUPANCY PERMIT (INCLUDING THE ASSOCIATED TRAFFIC CONTROL PLANS) MAY BE REQUIRED, AND IT IS THE CONTRACTOR'S RESPONSIBILITY TO OBTAIN ALL OF THESE PERMITS. APPROVED COPIES OF ALL REQUIRED PERMITS MUST BE SUBMITTED TO THE CITY CONSTRUCTION PROJECT MANAGER PRIOR TO THE START OF CONSTRUCTION.
5. A PARKS PERMIT WILL BE REQUIRED FOR ANY WORK OR OCCUPANCY OF PARK LAND, THIS INCLUDES BUT IS NOT LIMITED TO: DESIGNATED CITY PARKS, PARKWAYS, OPEN SPACE, TRAILS AND BIKE PATHS.
6. ALL DESIGN DRAWINGS PROVIDED AS PART OF THIS CONTRACT ARE FORMATTED FOR PRINTING FULL SIZE, ON STANDARD 22 X 34 INCH (ANSI D) PAPER SIZE AND TO HALF-SIZE (AND SCALE WHERE APPROPRIATE) ON STANDARD 11 X 17 PAPER SIZE. IT IS THE CONTRACTOR'S RESPONSIBILITY TO ENSURE THAT HARD COPIES OF PLANS UTILIZED FOR BIDDING OR CONSTRUCTION ARE PRINTED ON THE PROPER MEDIA SIZE AND THAT SCALES PROVIDED WITHIN THE DRAWINGS ARE CORRECTLY INTERPRETED.
7. "RED-LINED" DRAWINGS AND PRINTS ARE TO BE MAINTAINED BY THE CONTRACTOR AND SUBMITTED TO THE CITY CONSTRUCTION PROJECT MANAGER AT THE COMPLETION OF THE PROJECT. ANY AND ALL FIELD CHANGES MADE DURING CONSTRUCTION MUST BE NOTED. THE DRAWINGS WILL STATE "RED-LINES" IN LARGE BLOCK LETTERS. THE RED-LINED DRAWINGS MUST BE RECEIVED AND ACCEPTED BY THE CITY CONSTRUCTION PROJECT MANAGER PRIOR TO FINAL ACCEPTANCE AND SETTLEMENT.
8. THE CONTRACTOR SHALL NOTIFY THE CITY CONSTRUCTION PROJECT MANAGER IMMEDIATELY OF "ANY" DISCREPANCIES OR VARIATIONS IN DRAWINGS & SPECIFICATIONS THAT AFFECT PRICING OR THAT COULD REQUIRE MODIFICATION TO THE DESIGN.
9. THE CITY AND COUNTY OF DENVER ASSUMES NO RESPONSIBILITY FOR UTILITY LOCATIONS. THE UTILITIES SHOWN ON THESE DRAWINGS HAVE BEEN PLOTTED FROM THE BEST AVAILABLE INFORMATION. ALL UTILITIES MUST BE LOCATED BY THE CONTRACTOR. ALL COSTS ASSOCIATED WITH FIELD VERIFICATION OF LOCATION AND DEPTHS OF UTILITIES AND SHALL BE BORNE BY THE CONTRACTOR AND SHALL BE COMPLETED PRIOR TO THE COMMENCEMENT OF ANY CONSTRUCTION.
10. ALL RANGE POINTS OR OTHER SURVEY MONUMENTS WHICH MAY BE DAMAGED OR DESTROYED DURING CONSTRUCTION SHALL BE TIED OUT AND RESET PER CITY SURVEYING STANDARDS.
11. ALL ELEVATIONS SHOWN ARE NAVD88 DATUM, UNLESS OTHERWISE NOTED.
12. INLETS AND MANHOLES ARE NOT SHOWN TO SCALE ON THE PLAN AND PROFILE SHEETS.
13. INVERT ELEVATIONS AND CALCULATED PIPE SLOPES ON STORM AND SANITARY PROFILES ARE TO THE CENTER OF MANHOLE OR STRUCTURE. PIPE LENGTHS ARE TWO DIMENSIONAL LENGTHS AND ARE CENTER-TO-CENTER BETWEEN MANHOLES AND TO THE INSIDE EDGE OF INLETS.
14. NORTHING AND EASTING CALLOUTS ON TYPE 16 AND TYPE 14 INLETS ARE TO THE CENTER OF THE STRUCTURE AT THE FLOWLINE. NORTHING AND EASTING CALLOUTS ON MANHOLES ARE TO THE CENTER OF MANHOLE.
15. NOT APPLICABLE
16. NOT APPLICABLE
17. ALL SEWER MANHOLES MUST BE MAINTAINED AND ACCESSIBLE DURING CONSTRUCTION.
18. ALL SANITARY MANHOLES ARE 4' DIAMETER WITH "A" BASE AND CONCENTRIC CONE UNLESS NOTED OTHERWISE.
19. ALL MANHOLES BUILT WITHIN THIS PROJECT SHALL INCLUDE EITHER A 4" OR 8" CAST IRON RISER WITH 3" STEEL ADJUSTING RINGS.

**DENVER WATER**

20. IT SHALL BE THE CONTRACTOR'S RESPONSIBILITY TO TAKE WHATEVER STEPS NECESSARY TO PROTECT ALL WATER FACILITIES. IF ANY WATER FACILITIES CANNOT BE ADEQUATELY PROTECTED, THEN SAID WATER FACILITIES SHALL BE RELOCATED OR REMOVED IN ACCORDANCE WITH THE DENVER WATER DEPARTMENT REQUIREMENTS, BY A DENVER WATER PRE-QUALIFIED CONTRACTOR.
21. CONSTRUCTION ACTIVITIES BY ANY PARTY THAT DISTURB, RELOCATE, SEVER, OR IN ANY OTHER WAY IMPACT A SERVICE LINE SHALL BE REQUIRED TO MEET CURRENT DENVER WATER REQUIREMENTS FOR SERVICE LINES AS SPECIFIED IN CHAPTER 3 OF THE LATEST DENVER WATER STANDARDS. IN THE EVENT LEAD WATER LINES ARE ENCOUNTERED, DO NOT DISTURB, IMMEDIATELY STOP WORK, AND NOTIFY THE CITY CONSTRUCTION PROJECT MANAGER.

**METRO WASTEWATER RECLAMATION DISTRICT**

22. METRO WASTEWATER RECLAMATION DISTRICT MUST BE NOTIFIED AT LEAST 48 HOURS PRIOR TO CONSTRUCTION ON METRO FACILITIES IN ORDER FOR A DISTRICT INSPECTOR TO BE PRESENT DURING CONSTRUCTION. CONTRACTOR MUST CONTRACT METRO WASTEWATER RECLAMATION DISTRICT TO SCHEDULE THE INSPECTION 303-286-6000.

NO.	DESCRIPTION OF REVISIONS	DATE	BY

CALL UNCC  
TWO WORKING DAYS  
BEFORE YOU DIG  
1-800-422-1987  
UTILITY WATER CENTER OF  
COLORADO



CITY AND COUNTY OF DENVER  
DEPARTMENT OF PUBLIC WORKS  
ENGINEERING DIVISION  
CAPITAL PROJECTS MANAGEMENT  
2000 W. 3RD AVE. DENVER, CO 80223  
TEL.: (303) 446-3617 FAX: (303) 446-3647

CHERRY CREEK EAST SANITARY  
IMPROVEMENTS  
PRO TRACKING NO: PWWW2018-001  
PROJECT MASTER NO: 2018-PROJMSTR-0000089

DRAWN BY:	CJM
DESIGNED BY:	-
APPROVED BY:	JJC
DRAWING NAME:	DETAILS AND NOTES.dwg
DATE:	04/20/2018
SHEET NO.:	2 OF 32

**FORESTRY NOTES:**

**OFFICE OF THE CITY FORESTER NOTES FOR UTILITY PLAN SUBMITTALS - OCTOBER 2017**

1. UTILITY PROJECTS THAT DO NOT GO THROUGH THE OFFICE OF THE CITY FORESTER (OCF) REVIEW PROCESS OR DO NOT RECEIVE OCF APPROVAL; OCF RESERVES THE RIGHT TO PLANT IN THE PRW AND CANNOT BE HELD LIABLE FOR ANY DAMAGE THAT OCCURS TO UTILITY WITHIN PRW WHERE UTILITY IS NOT PLACED AT A MINIMUM DEPTH OF 36 INCHES.
2. OCF RESERVES THE RIGHT TO DECLARE UNENCUMBERED SPACE IN THE PRW FOR FUTURE AND REPLACEMENT PRW TREES. SHOULD THESE AREAS BE VIOLATED BY ANY UTILITY, THE UTILITY OWNER SHALL (RE)MOVE UTILITY AT OWNER'S EXPENSE.
3. THE CONTRACTOR SHALL NOT SPRAY, CUT, OR TRIM TREES OR OTHER LANDSCAPING ELEMENTS WITHIN ROW, UNLESS SUCH WORK IS OTHERWISE SPECIFIED OR CLEARLY INDICATED ON THE APPROVED PLANS.
4. ANY DISTURBED LANDSCAPING WILL BE REPLACED TO EQUAL OR BETTER CONDITION THAN THAT WHICH EXISTED PRIOR TO WORK.
5. SEEDING, SODDING, AND PLANTING SHALL BE AS SPECIFIED OR OTHERWISE APPROVED BY THE CITY. CONSTRUCTION, MAINTENANCE, AND WATERING REQUIREMENTS SHALL CONFORM TO THE CITY STANDARD SPECIFICATIONS. WHERE LANDSCAPE RESTORATION MUST BE DELAYED DUE TO SEASONAL REQUIREMENTS, A SEPARATE PERMIT MAY AUTHORIZE SUCH WORK.
6. THE CITY REQUIRES COMPLIANCE WITH THE FOLLOWING WHEN WORK IS NECESSARY AND/OR REQUIRED ADJACENT TO TREES IN THE PRW OR OTHER PUBLIC SPACES:
  - a) TREE PROTECTION ZONE (TPZ) IS THE AREA EQUAL TO 1.5 FEET PER 1-INCH DIAMETER TREE MEASURED AT 4.5 FEET ABOVE GRADE OR THE DRIPLINE OF THE TREE, WHICHEVER IS GREATER.
    - i. TPZ FENCING SHALL BE ESTABLISHED PRIOR TO WORK COMMENCING, SEE TREE PROTECTION DETAIL AVAILABLE ON WEBSITE.
    - ii. NO MODIFICATION OF TPZ FENCING SHALL OCCUR WITHOUT PRIOR AUTHORIZATION FROM OCF.
    - iii. NO EXCAVATION OR EQUIPMENT STORAGE SHALL OCCUR WITHIN THE TPZ WITHOUT PRIOR AUTHORIZATION FROM OCF
    - iv. HAND WORK ONLY WITHIN THIS AREA UNLESS PRIOR AUTHORIZATION GIVEN BY OCF.
    - v. ROOTS 2 INCHES AND LARGER SHALL NOT BE CUT. IF CONFLICT ARISES, CONTRACTOR MUST CONTACT OCF PRIOR TO CONTINUANCE OF WORK.
  - b) ALL PIT LOCATIONS MUST BE STAKED AND APPROVED PRIOR TO AN EXCAVATION.
  - c) TRENCHING SHALL NOT OCCUR WITHIN THE TPZ WITHOUT VERIFYING LOCATION OF EXISTING ROOTS THAT MAY BE IMPACTED BY EXCAVATION:
    - i. APPROVED ROOT DISCOVERY METHODS INCLUDE: HAND WORK, AIR SPADE, GROUND PENETRATING RADAR, OR OTHER OCF APPROVED METHOD.
    - ii. ADJUST THE ROUTE TO AVOID ROOTS AS MUCH AS POSSIBLE.
    - iii. MINIMIZE THE WORK PIT TO NO WIDER THAN THE TRENCH.
    - iv. STORE SOIL OPPOSITE THE TREE SIDE OF THE TRENCH.
    - v. BACKFILL QUICKLY AND CLEANLY, AND WATER ROOTS DEEPLY.
    - vi. EXPOSED ROOTS MUST BE KEPT MOIST AT ALL TIMES. COVER EXPOSED ROOTS WITH BURLAP OR OTHER MATERIAL THAT WILL HOLD MOISTURE AGAINST EXPOSED ROOTS.
  - d) TUNNELING/DIRECTIONAL BORING MUST BE AT LEAST 36 INCHES BELOW GRADE, 48 INCHES PREFERRED.
    - i. FINAL DEPTH OF INSTALLED UTILITY MUST BE AT A MINIMUM OF 36 INCHES BELOW FINAL GRADE. DUE TO THE INABILITY TO CONSISTENTLY MAINTAIN ACCURATE BORING DEPTHS, IT IS STRONGLY RECOMMENDED TO TARGET A DEPTH OF 48 INCHES TO ENSURE NO VIOLATION OF THE 36-INCH MINIMUM DEPTH OCCURS. THE CITY MAY ORDER THE LOWERING OF INSTALLED UTILITIES WHEN THEY ARE DISCOVERED NOT TO BE DEEPER THAN THE 36-INCH MINIMUM.
  - e) THE CRITICAL ROOT ZONE (CRZ) IS THE AREA WITHIN THE TPZ AND EQUAL TO 1 LINEAR FOOT RADIUS PER 1-INCH DIAMETER OF TREE TRUNK MEASURED AT 4.5 FEET ABOVE THE GROUND.
    - i. NO ROOT DISTURBANCE SHALL OCCUR WITHIN THIS AREA.
      - a. IF NOT POSSIBLE, CONTRACTOR MUST MEET WITH OCF PERSONNEL ON SITE.

WHEN WORK OCCURS WITHIN CRZ, EXCAVATION MUST BE PERFORMED WITH HAND-TOOLS, AIR SPADE, OR OTHER OCF APPROVED METHOD.
  - f) THE STRUCTURAL ROOT ZONE (SRZ) IS THE AREA WITHIN THE TPZ AND EQUAL TO 0.9 TIMES PER INCH DIAMETER OF THE TREE MEASURED AT 4.5 FEET ABOVE THE GROUND (0.9\*X).
    - i. NO ACTIVITY SHALL OCCUR WITHIN THIS ZONE WITH THE EXCEPTION OF DIRECTIONAL BORING AT A MINIMUM DEPTH OF 36 INCHES BELOW GRADE, 48 INCHES PREFERRED.
      - a. FINAL DEPTH OF INSTALLED UTILITY MUST BE AT A MINIMUM OF 36 INCHES BELOW FINAL GRADE. DUE TO THE INABILITY TO CONSISTENTLY MAINTAIN ACCURATE BORING DEPTHS, IT IS STRONGLY RECOMMENDED TO TARGET A DEPTH OF 48 INCHES TO ENSURE NO VIOLATION OF THE 36-INCH MINIMUM DEPTH OCCURS. THE CITY MAY ORDER THE LOWERING OF INSTALLED UTILITIES WHEN THEY ARE DISCOVERED NOT TO BE DEEPER THAN THE 36-INCH MINIMUM.
7. SHOULD ANY TREE DAMAGE OCCUR, CONTRACTOR SHALL CONTACT THE OCF IMMEDIATELY
  - a) RETAIN AN OCF - LICENSED TREE COMPANY TO PRUNE BROKEN BRANCHES AS WELL AS COMPENSATORY PRUNING IF NECESSARY FROM ROOT LOSS.
8. THE CITY & COUNTY OF DENVER TREE RETENTION AND PROTECTION SPECIFICATIONS MUST BE FOLLOWED. FOR A COPY OF THE TREE PROTECTION SPECIFICATIONS PLEASE CONTACT THE OFFICE OF THE CITY FORESTER AT (720) 913-0651 OR EMAIL AT FORESTRY@DENVERGOV.ORG

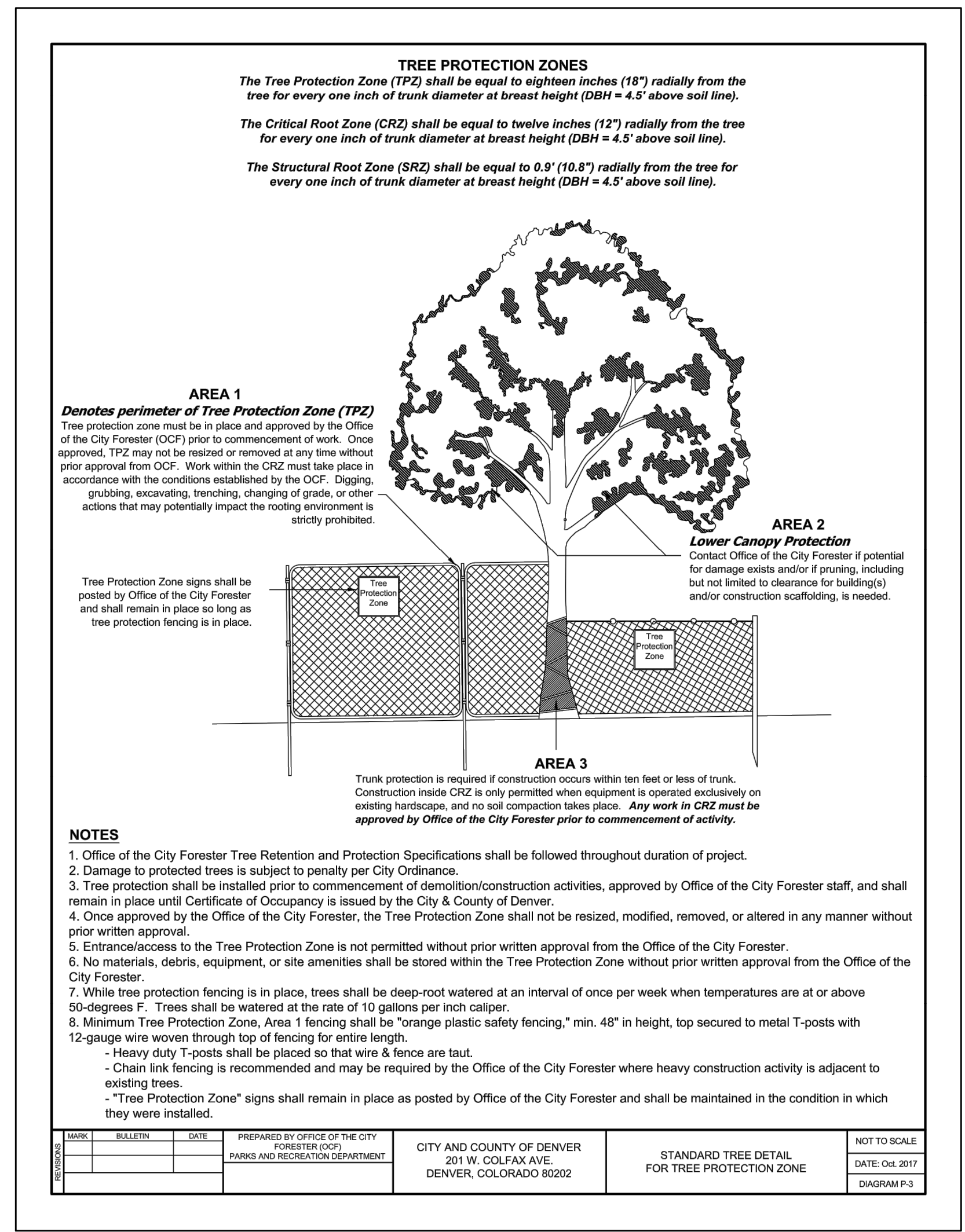

CALL UNCC TWO WORKING DAYS BEFORE YOU DIG 1-800-422-1987 UTILITY NUISANCE CENTER OF COLORADO	CITY AND COUNTY OF DENVER DEPARTMENT OF PUBLIC WORKS ENGINEERING DIVISION CAPITAL PROJECTS MANAGEMENT 2000 W. 3RD AVE. DENVER, CO 80223 TEL.: (303) 446-3617 FAX: (303) 446-3647	CHERRY CREEK EAST SANITARY IMPROVEMENTS PRO TRACKING NO: PWWW2018-001 PROJECT MASTER NO: 2018-PROJMSTR-0000089	FORESTRY NOTES
DRAWN BY: CJM	DESIGNED BY: -	APPROVED BY: JJC	DRAWING NAME: DETAILS AND NOTES.dwg
DATE: 04/20/2018	SHEET NO.: 3 OF 32		

S:\STAFF\_FOLDERS\COKELEY\UNCC\CHERRY\_CREEK\_EAST\_DETAILS AND NOTES.DWG PLOT DATE: May 25, 2018

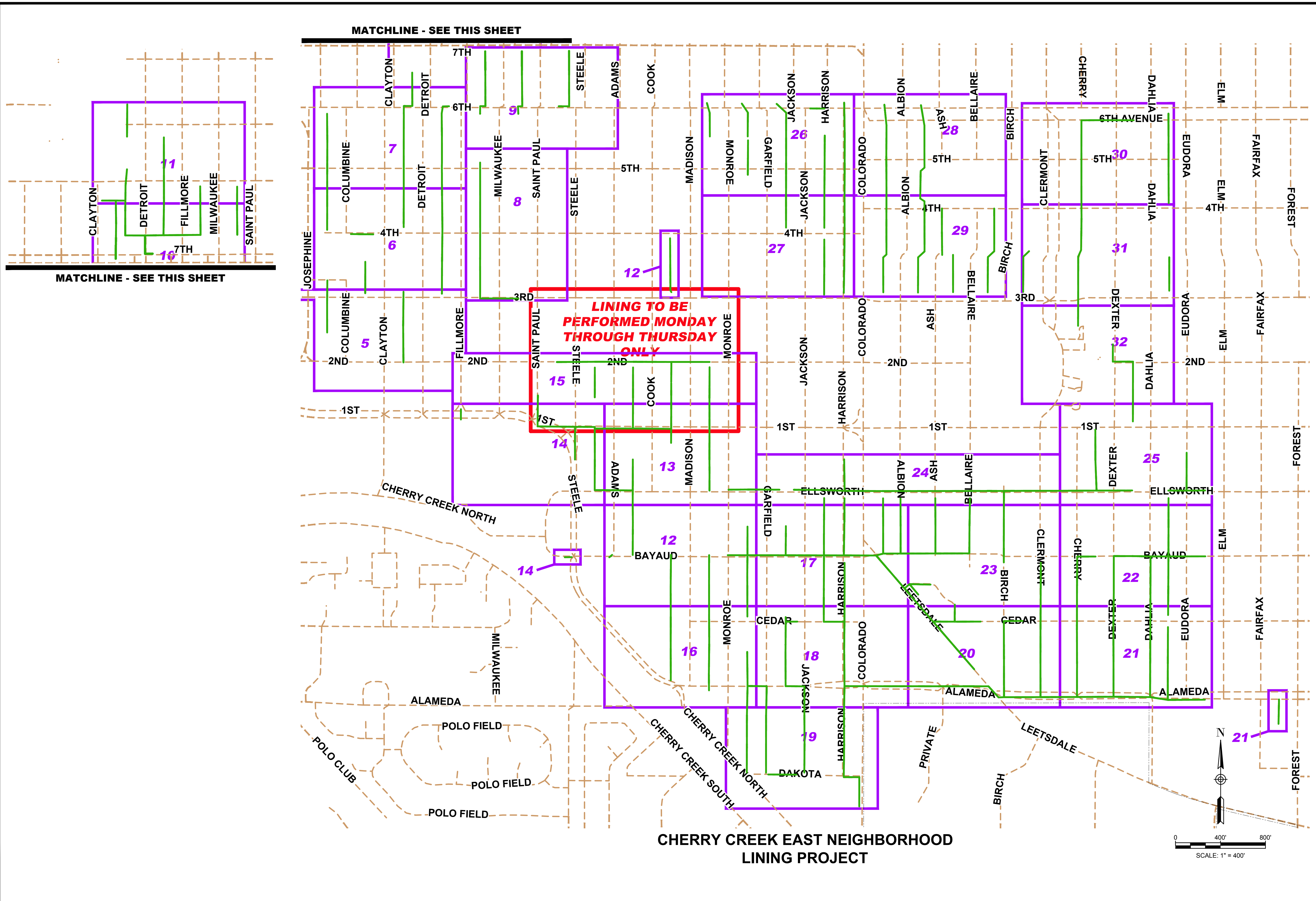

MATCHLINE - SEE THIS SHEET

MATCHLINE - SEE THIS SHEET

### CHERRY CREEK EAST NEIGHBORHOOD LINING PROJECT

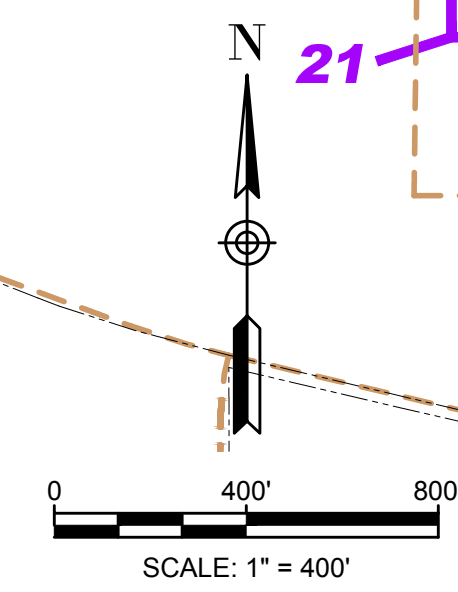

NO.	DESCRIPTION OF REVISIONS	DATE	BY

CALL UNCC  
TWO WORKING DAYS  
BEFORE YOU DIG  
1-800-402-1987  
UTILITY SERVICES CENTER OF  
COLORADO



CITY AND COUNTY OF DENVER  
DEPARTMENT OF PUBLIC WORKS  
ENGINEERING DIVISION  
CAPITAL PROJECTS MANAGEMENT  
2000 W. 3RD AVE. DENVER, CO 80223  
TEL.: (303) 446-3617 FAX: (303) 446-3647

CHERRY CREEK EAST SANITARY IMPROVEMENTS  
PRO TRACKING NO: PWWW2018-001  
PROJECT MASTER NO: 2018-PROJMSTR-0000089  
KEY MAP

DRAWN BY:	CJM
DESIGNED BY:	-
APPROVED BY:	JJC
DRAWING NAME:	KEY_MAP.dwg
DATE:	04/20/2018
SHEET NO.:	4 OF 32

PLOT DATE: May 25, 2018

S:\STAFF\_FOLDERS\COKELEY\UNINC\_PROJECTS\CHERRY\_CREEK\_EAST\SHEET 5.DWG

MATCHLINE - SEE SHEET 6

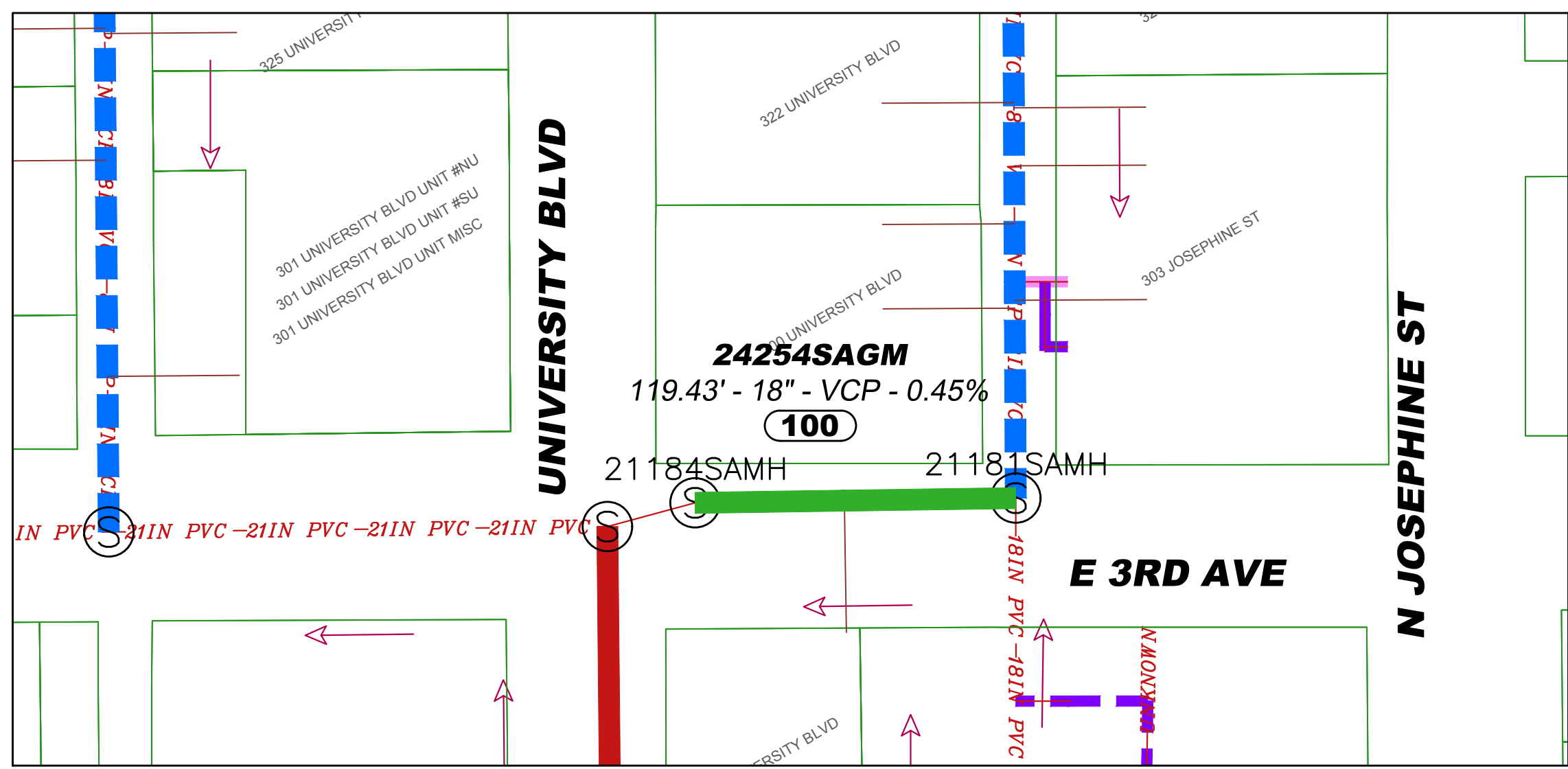
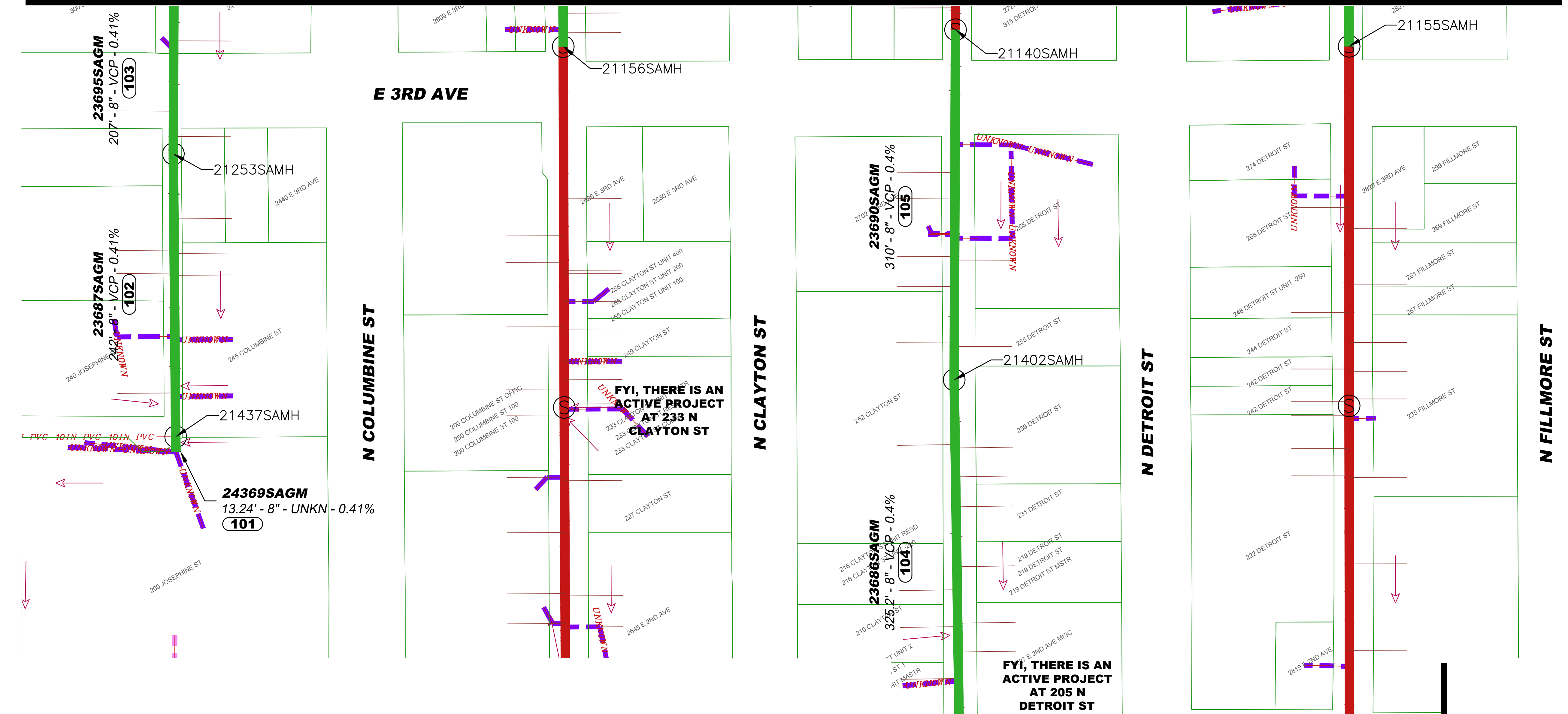

E 3RD AVE SANITARY - UNIVERSITY BLVD TO N JOSEPHINE ST

MATCHLINE - SEE SHEET 8

NO.	DESCRIPTION OF REVISIONS	DATE	BY

CALL UNCC  
TWO WORKING DAYS  
BEFORE YOU DIG  
1-800-422-1987  
UTILITY SERVICES CENTER OF  
COLORADO

CITY AND COUNTY OF DENVER  
DEPARTMENT OF PUBLIC WORKS  
ENGINEERING DIVISION  
CAPITAL PROJECTS MANAGEMENT  
2000 W. 3RD AVE. DENVER, CO 80223  
TEL.: (303) 446-3617 FAX: (303) 446-3647

CHERRY CREEK EAST SANITARY  
IMPROVEMENTS  
PRO TRACKING NO: PWWW2018-001  
PROJECT MASTER NO: 2018-PROJMSTR-0000089

DRAWN BY:	CJM
DESIGNED BY:	-
APPROVED BY:	JJC
DRAWING NAME:	Sheet 5.dwg
DATE:	04/20/2018
SHEET NO.:	5 OF 32

SHEET 5

PLOT DATE: May 25, 2018

S:\STAFF\_FOLDERS\COKELEY\UNINC\_PROJECTS\CAD\CHERRY\_CREEK\_EAST\SHEET 6.DWG

MATCHLINE - SEE SHEET 7

MATCHLINE - SEE SHEET 5

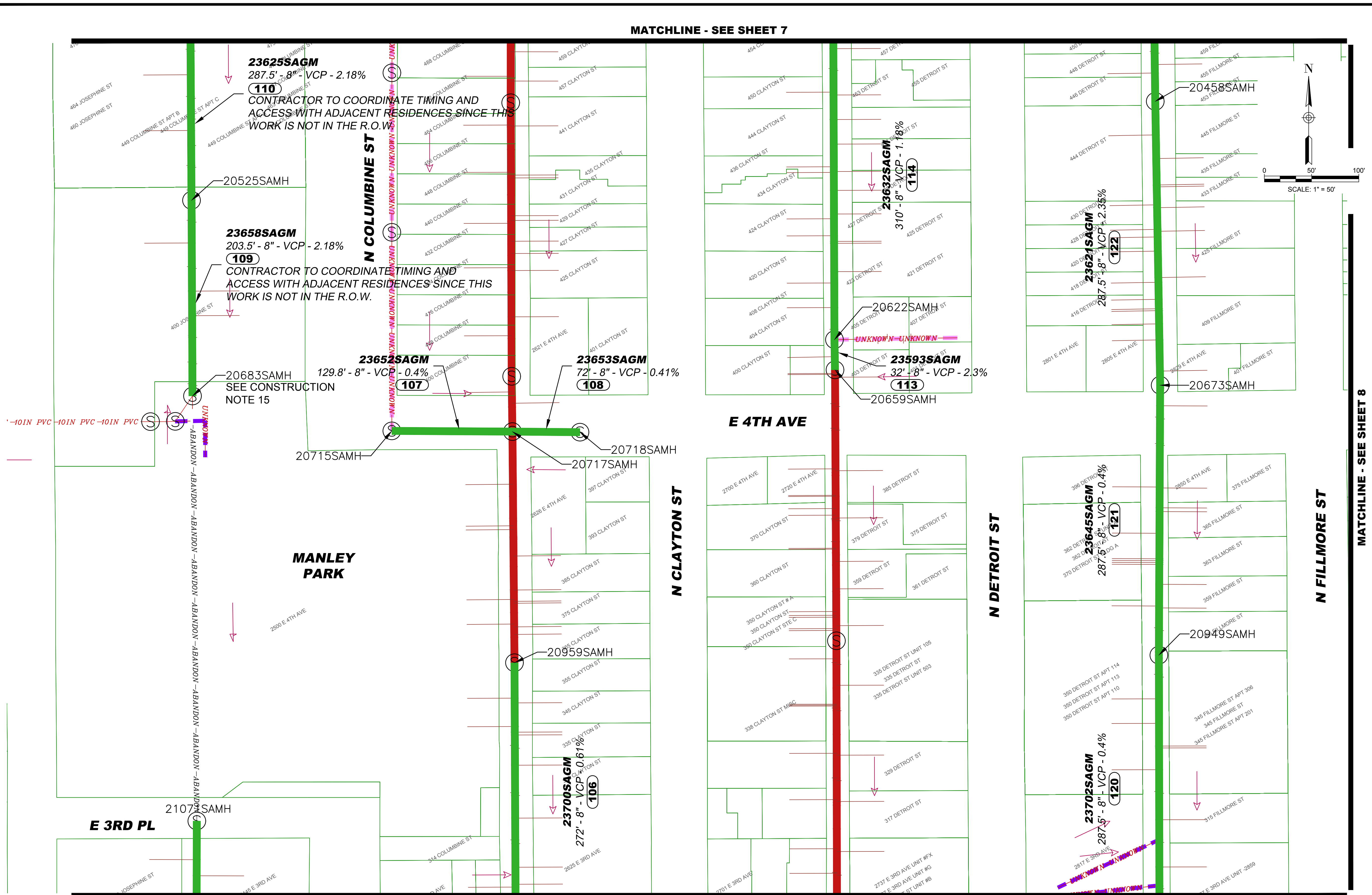

MATCHLINE - SEE SHEET 8

NO.	DESCRIPTION OF REVISIONS	DATE	BY

CALL UNCC  
TWO WORKING DAYS  
BEFORE YOU DIG  
1-800-422-1987  
UTILITY SERVICES CENTER OF  
COLORADO

CITY AND COUNTY OF DENVER  
DEPARTMENT OF PUBLIC WORKS  
ENGINEERING DIVISION  
CAPITAL PROJECTS MANAGEMENT  
2000 W. 3RD AVE. DENVER, CO 80223  
TEL.: (303) 446-3617 FAX: (303) 446-3647

CHERRY CREEK EAST SANITARY  
IMPROVEMENTS  
PRO TRACKING NO: PWWW2018-001  
PROJECT MASTER NO: 2018-PROJMSTR-0000089

DRAWN BY: CJM  
DESIGNED BY: -  
APPROVED BY: JJC  
DRAWING NAME: Sheet 6.dwg  
DATE: 04/20/2018  
SHEET NO.: 6 OF 32

SHEET 6

PLOT DATE: May 25, 2018

S:\STAFF\_FOLDERS\COKELEY\UNINC\_PROJECTS\CHERRY\_CREEK\EAST\SHEET 7.DWG

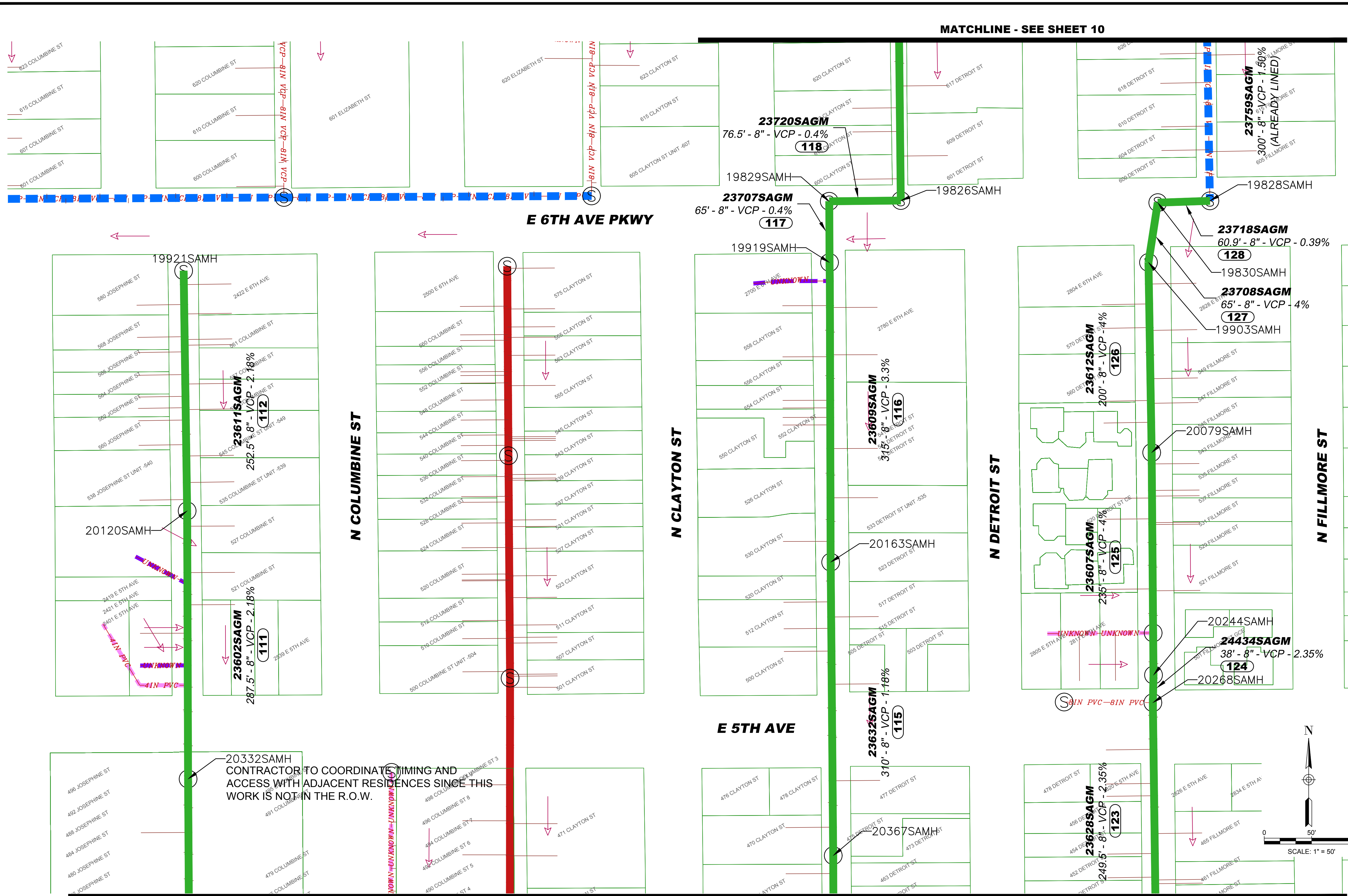

20332SAMH CONTRACTOR TO COORDINATE TIMING AND ACCESS WITH ADJACENT RESIDENCES SINCE THIS WORK IS NOT IN THE R.O.W.

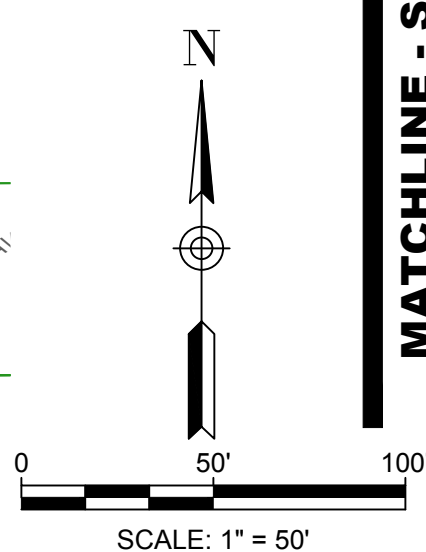

MATCHLINE - SEE SHEET 10

E 6TH AVE PKWY

E 5TH AVE

MATCHLINE - SEE SHEET 6

MATCHLINE - SEE SHEET 9

MATCHLINE - SEE SHEET 8

NO.	DESCRIPTION OF REVISIONS	DATE	BY

CALL UNCC  
TWO WORKING DAYS  
BEFORE YOU DIG  
1-800-422-1987  
UTILITY INFORMATION CENTER OF  
COLORADO

CITY AND COUNTY OF DENVER  
DEPARTMENT OF PUBLIC WORKS  
ENGINEERING DIVISION  
CAPITAL PROJECTS MANAGEMENT  
2000 W. 3RD AVE. DENVER, CO 80223  
TEL.: (303) 446-3617 FAX: (303) 446-3647

CHERRY CREEK EAST SANITARY  
IMPROVEMENTS

PRO TRACKING NO: PWWW2018-001  
PROJECT MASTER NO: 2018-PROJMSTR-0000089

SHEET 7

DRAWN BY:	CJM
DESIGNED BY:	-
APPROVED BY:	JJC
DRAWING NAME:	Sheet 7.dwg
DATE:	04/20/2018
SHEET NO.:	7 OF 32

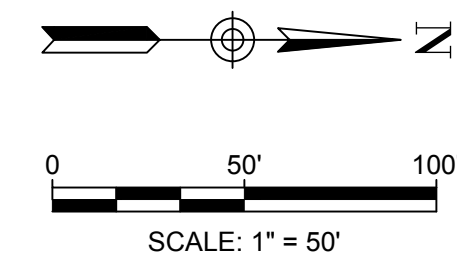

**MATCHLINE  
SEE SHEET 5**

**MATCHLINE - SEE SHEET 6**

**MATCHLINE - SEE SHEET 6**

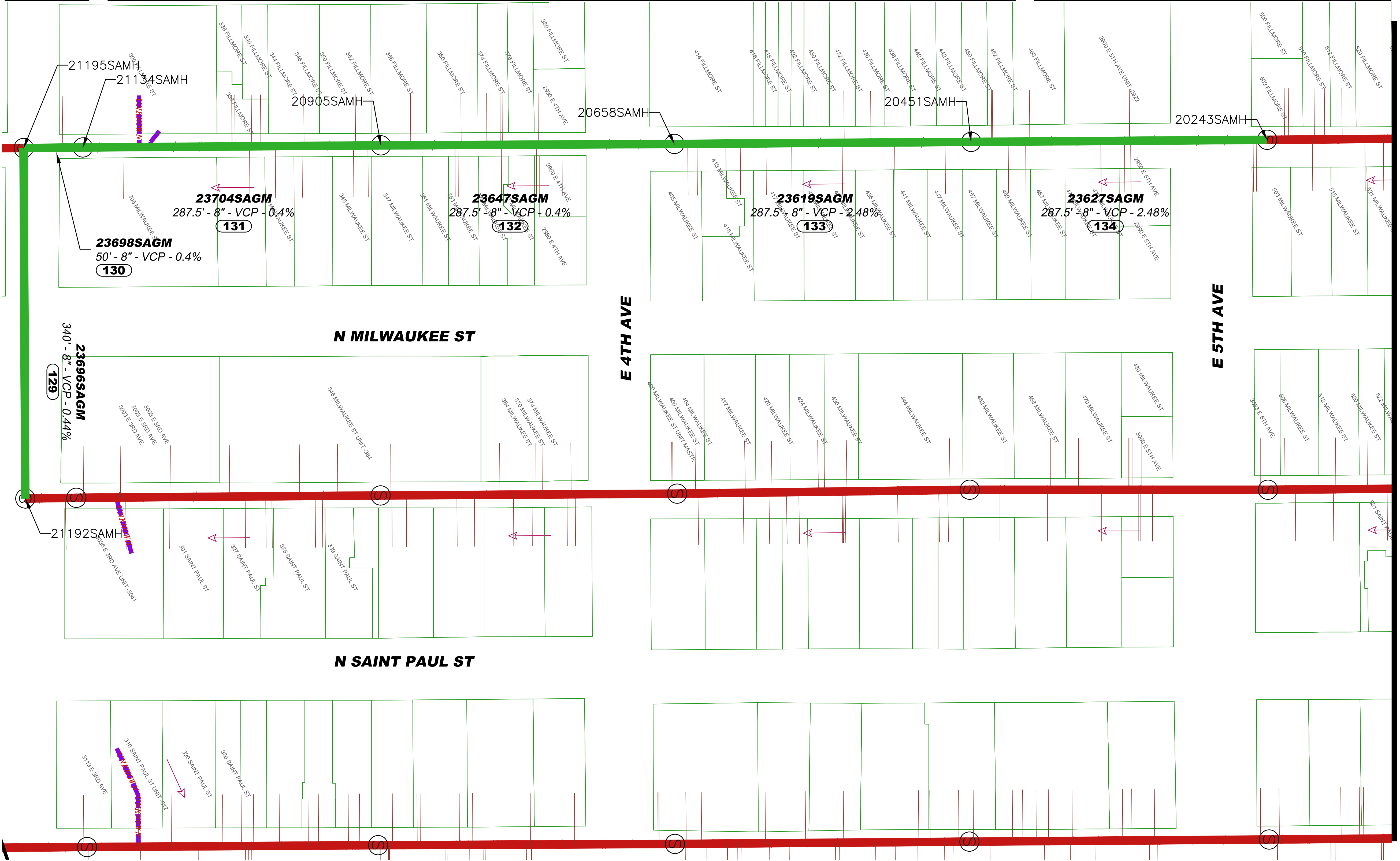

**MATCHLINE - SEE SHEET 9**

NO.	DESCRIPTION OF REVISIONS	DATE	BY

CALL UNCC  
TWO WORKING DAYS  
BEFORE YOU DIG  
1-800-422-1987  
UTILITY SUPERVISOR CENTER OF  
COLORADO



CITY AND COUNTY OF DENVER  
DEPARTMENT OF PUBLIC WORKS  
ENGINEERING DIVISION  
CAPITAL PROJECTS MANAGEMENT  
2000 W. 3RD AVE. DENVER, CO 80223  
TEL.: (303) 446-3617 FAX: (303) 446-3647

**CHERRY CREEK EAST & FIVE POINTS  
SANITARY SEWER IMPROVEMENTS**  
  
PRO TRACKING NO: PWWW2018-001  
PROJECT MASTER NO: 2018-PROJMSTR-0000089

DRAWN BY:	CJM
DESIGNED BY:	-
APPROVED BY:	JJC
DRAWING NAME:	Sheet 8.dwg
DATE:	04/20/2018
SHEET NO.:	8 OF 32

PLOT DATE: May 25, 2018

S:\STAFF\_FOLDERS\COKELEY\UNCC\_PROJECTS\COA\CHERRY\_CREEK\_EAST\SHEET 8.DWG

SHEET 8





PLOT DATE: May 25, 2018

S:\STAFF\_FOLDERS\COKELEY\LINING\_PROJECTS\COA\CHERRY\_CREEK\_EAST\SHEET 10.DWG

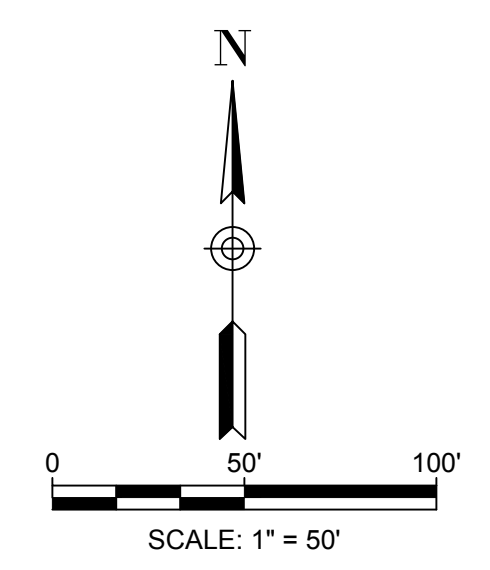
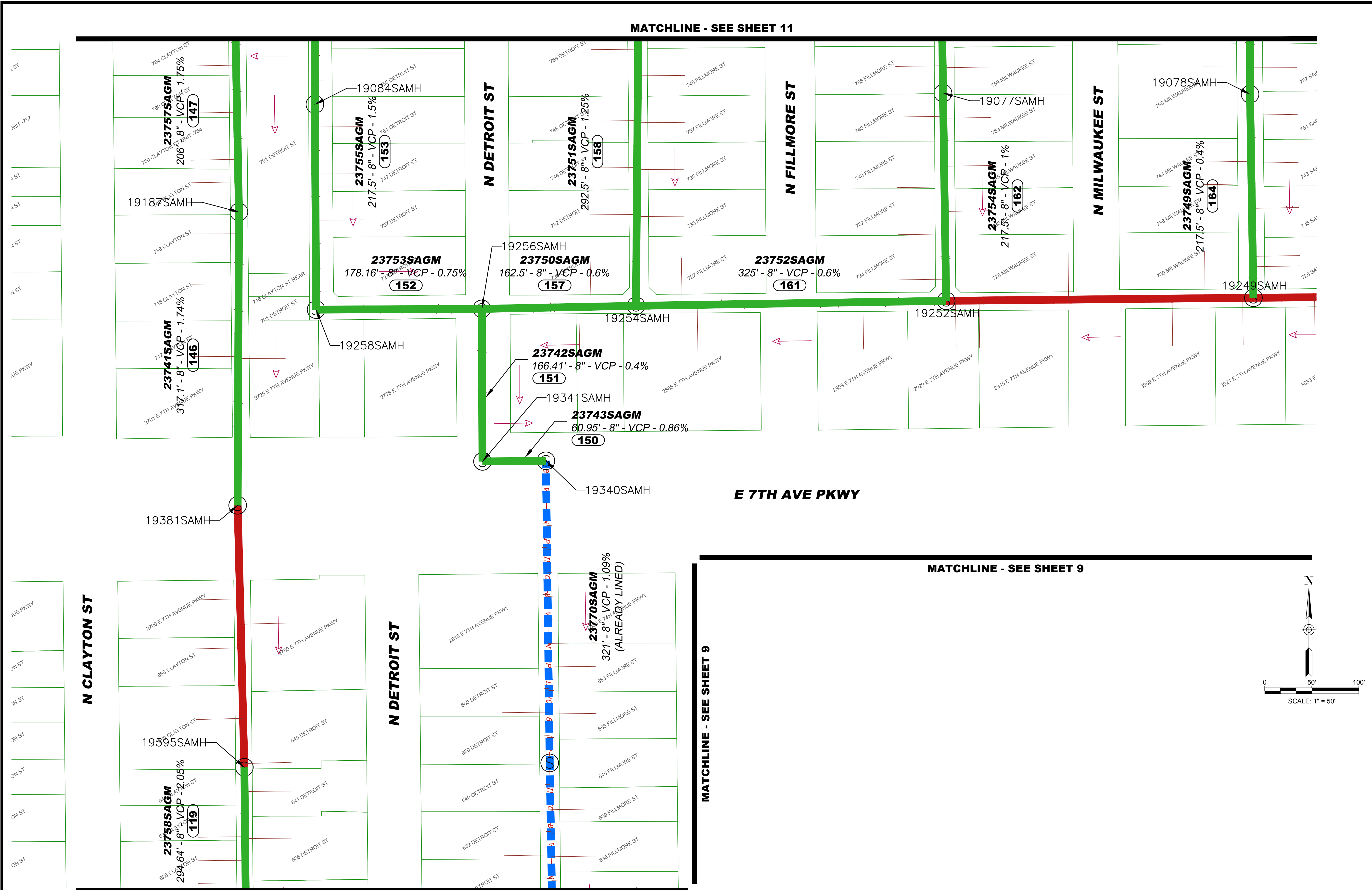

NO.	DESCRIPTION OF REVISIONS	DATE	BY

CALL UNCC  
TWO WORKING DAYS  
BEFORE YOU DIG  
1-800-422-1987  
UTILITY SERVICES CENTER OF  
COLORADO



CITY AND COUNTY OF DENVER  
DEPARTMENT OF PUBLIC WORKS  
ENGINEERING DIVISION  
CAPITAL PROJECTS MANAGEMENT  
2000 W. 3RD AVE. DENVER, CO 80223  
TEL.: (303) 446-3617 FAX: (303) 446-3647

CHERRY CREEK EAST SANITARY  
IMPROVEMENTS  
PRO TRACKING NO: PWWW2018-001  
PROJECT MASTER NO: 2018-PROJMSTR-0000089

DRAWN BY:	CJM
DESIGNED BY:	-
APPROVED BY:	JJC
DRAWING NAME:	Sheet 10.dwg
DATE:	04/20/2018
SHEET NO.:	10 OF 32

SHEET 10





MATCHLINE - SEE SHEET 15

MATCHLINE - SEE SHEET 12

LINING TO BE PERFORMED  
MONDAY THROUGH THURSDAY  
ONLY FROM S SAINT PAUL STREET  
TO S MONROE STREET BETWEEN  
E 1ST AVE TO E 3RD AVE

CONTRACTOR TO COORDINATE  
TIMING AND ACCESS WITH  
ADJACENT BUSINESSES SINCE  
THIS LINE IS NOT IN R.O.W.

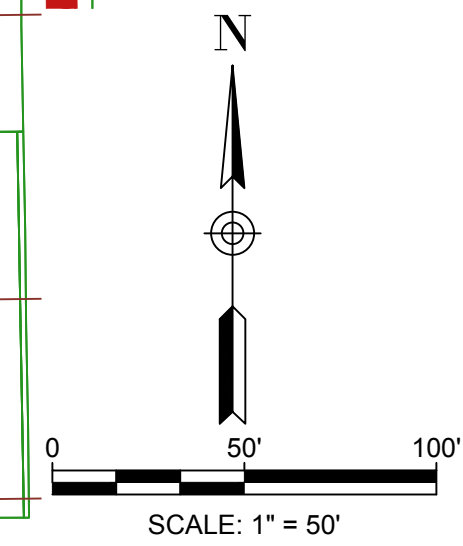

MATCHLINE - SEE SHEET 14

MATCHLINE - SEE SHEET 24

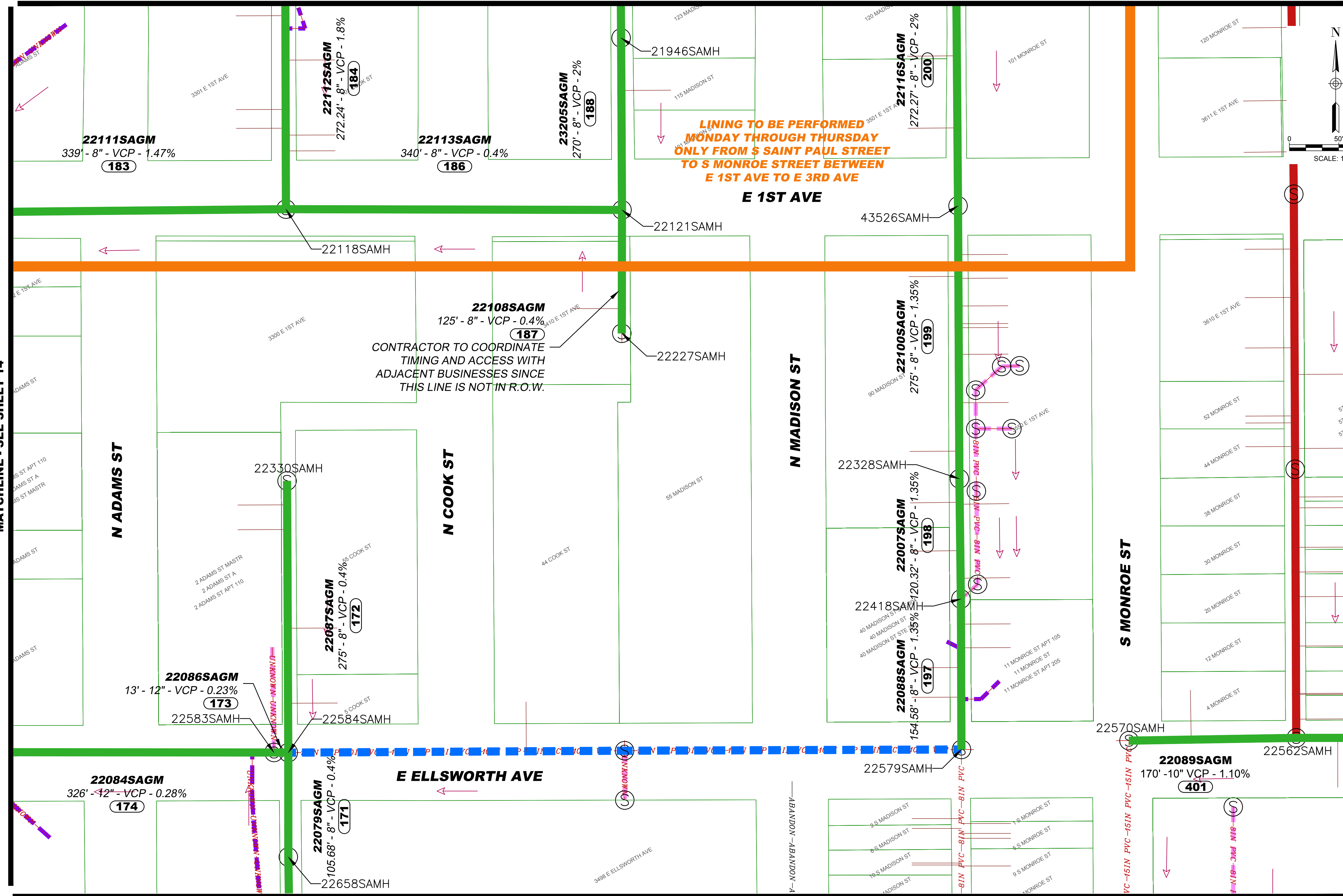

NO.	DESCRIPTION OF REVISIONS	DATE	BY

  

<p>CALL UNCC TWO WORKING DAYS BEFORE YOU DIG 1-800-422-1987 UTILITY SERVICES CENTER OF COLORADO</p>
<p>CITY AND COUNTY OF DENVER DEPARTMENT OF PUBLIC WORKS ENGINEERING DIVISION CAPITAL PROJECTS MANAGEMENT 2000 W. 3RD AVE. DENVER, CO 80223 TEL.: (303) 446-3617 FAX: (303) 446-3647</p>
<p>CHERRY CREEK EAST SANITARY IMPROVEMENTS</p> <p>PRO TRACKING NO: PWWW2018-001 PROJECT MASTER NO: 2018-PROJMSTR-0000089</p>
<p>DRAWN BY: CJM DESIGNED BY: - APPROVED BY: JJC DRAWING NAME: Sheet 13.dwg DATE: 04/20/2018 SHEET NO.: 13 OF 32</p>



PLOT DATE: May 25, 2018

S:\STAFF\_FOLDERS\COKELEY\LINING\_PROJECTS\CHERRY\_CREEK\_EAST\SHEET\_15.DWG

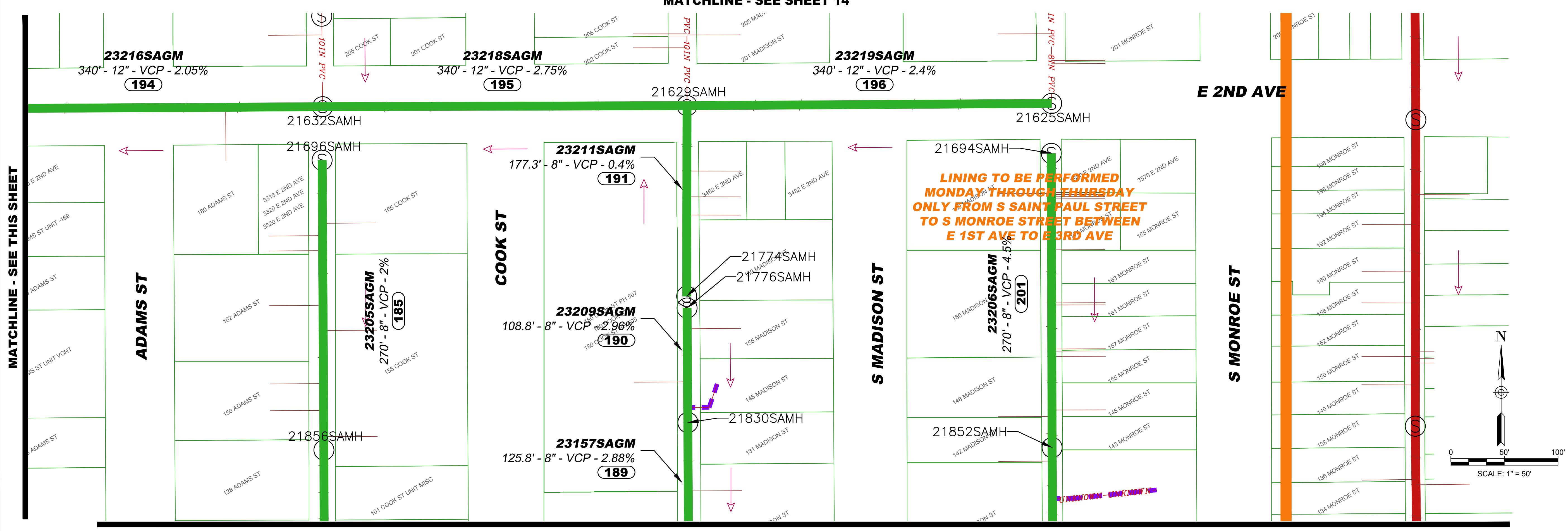
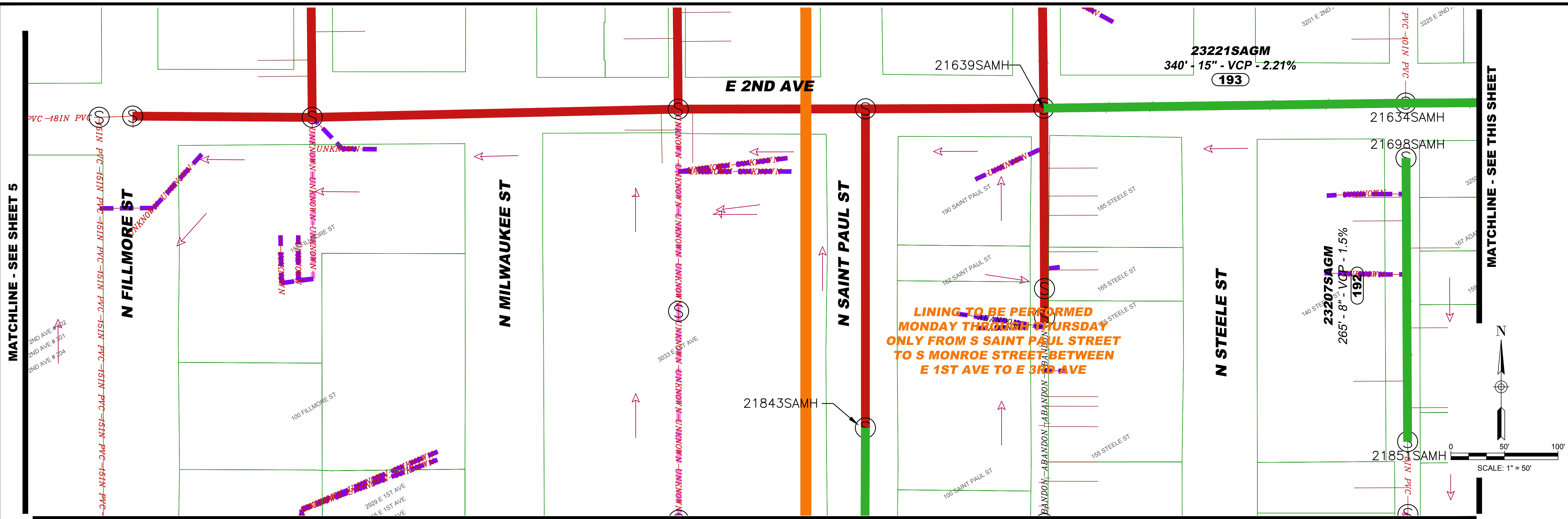

**LINING TO BE PERFORMED MONDAY THROUGH THURSDAY ONLY FROM S SAINT PAUL STREET TO S MONROE STREET BETWEEN E 1ST AVE TO E 3RD AVE**

**LINING TO BE PERFORMED MONDAY THROUGH THURSDAY ONLY FROM S SAINT PAUL STREET TO S MONROE STREET BETWEEN E 1ST AVE TO E 3RD AVE**

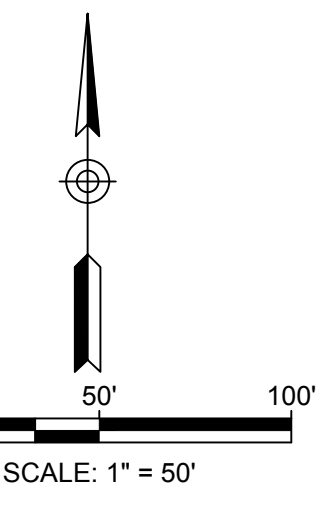
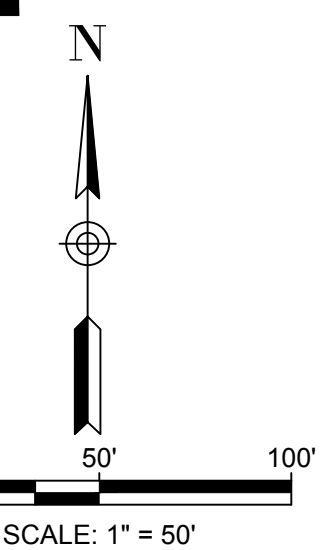

DESCRIPTION OF REVISIONS		DATE	BY

CALL UNCC TWO WORKING DAYS BEFORE YOU DIG	
1-800-422-1987 UTILITY SUPERVISOR CENTER OF COLORADO	

CITY AND COUNTY OF DENVER DEPARTMENT OF PUBLIC WORKS ENGINEERING DIVISION CAPITAL PROJECTS MANAGEMENT 2000 W. 3RD AVE. DENVER, CO 80223 TEL.: (303) 446-3617 FAX: (303) 446-3647
---

CHERRY CREEK EAST SANITARY IMPROVEMENTS	PRO TRACKING NO: PWWW2018-001
	PROJECT MASTER NO: 2018-PROJMSTR-0000089
DRAWN BY: CJM	
DESIGNED BY: -	
APPROVED BY: JJC	
DRAWING NAME: Sheet 15.dwg	
DATE: 04/20/2018	
SHEET NO.: 15	OF 32





MATCHLINE - SEE SHEET 24

MATCHLINE - SEE SHEET 12

MATCHLINE - SEE SHEET 23

MATCHLINE - SEE SHEET 18

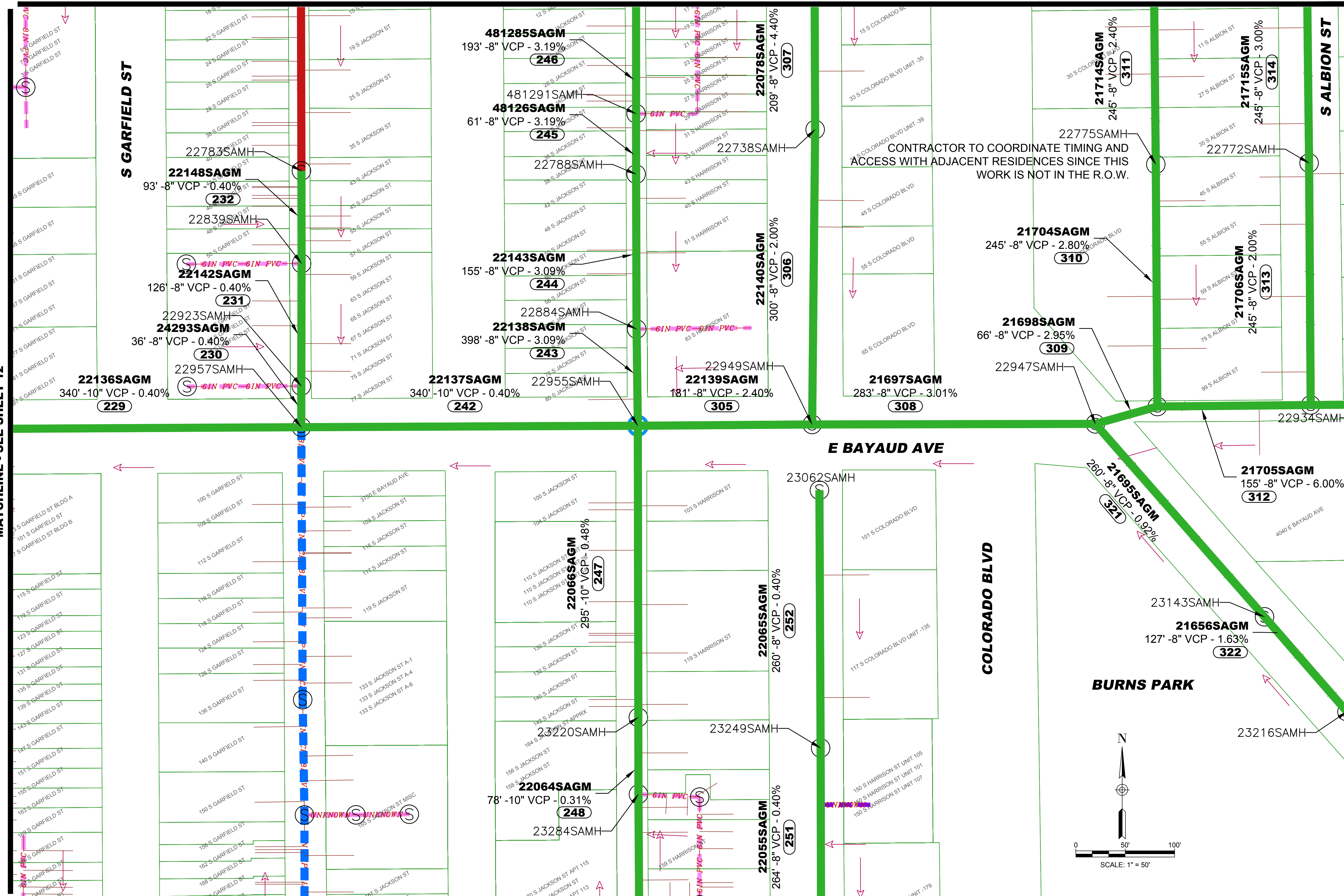

NO.	DESCRIPTION OF REVISIONS	DATE	BY

CALL UNCC  
TWO WORKING DAYS  
BEFORE YOU DIG  
1-800-422-1987  
UTILITY SERVICES CENTER OF  
COLORADO

CITY AND COUNTY OF DENVER  
DEPARTMENT OF PUBLIC WORKS  
ENGINEERING DIVISION  
CAPITAL PROJECTS MANAGEMENT  
2000 W. 3RD AVE. DENVER, CO 80223  
TEL.: (303) 446-3617 FAX: (303) 446-3647

CHERRY CREEK EAST SANITARY  
IMPROVEMENTS

PRO TRACKING NO: PWWW2018-001  
PROJECT MASTER NO: 2018-PROJMSTR-0000089

DRAWN BY: CJM  
DESIGNED BY: -  
APPROVED BY: JJC  
DRAWING NAME: Sheet 17.dwg  
DATE: 04/20/2018  
SHEET NO.: 17 OF 32

PLOT DATE: May 25, 2018

S:\STAFF\_FOLDERS\COKELEY\UNINC\_PROJECTS\COA\CHERRY\_CREEK\_EAST\_SHEET\_18.DWG

MATCHLINE - SEE SHEET 17

MATCHLINE - SEE SHEET 16

MATCHLINE - SEE SHEET 20

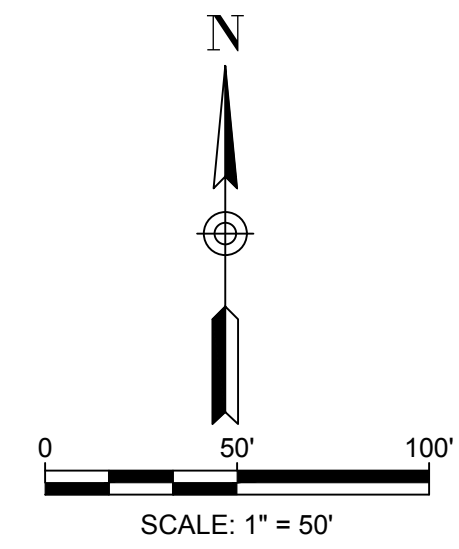
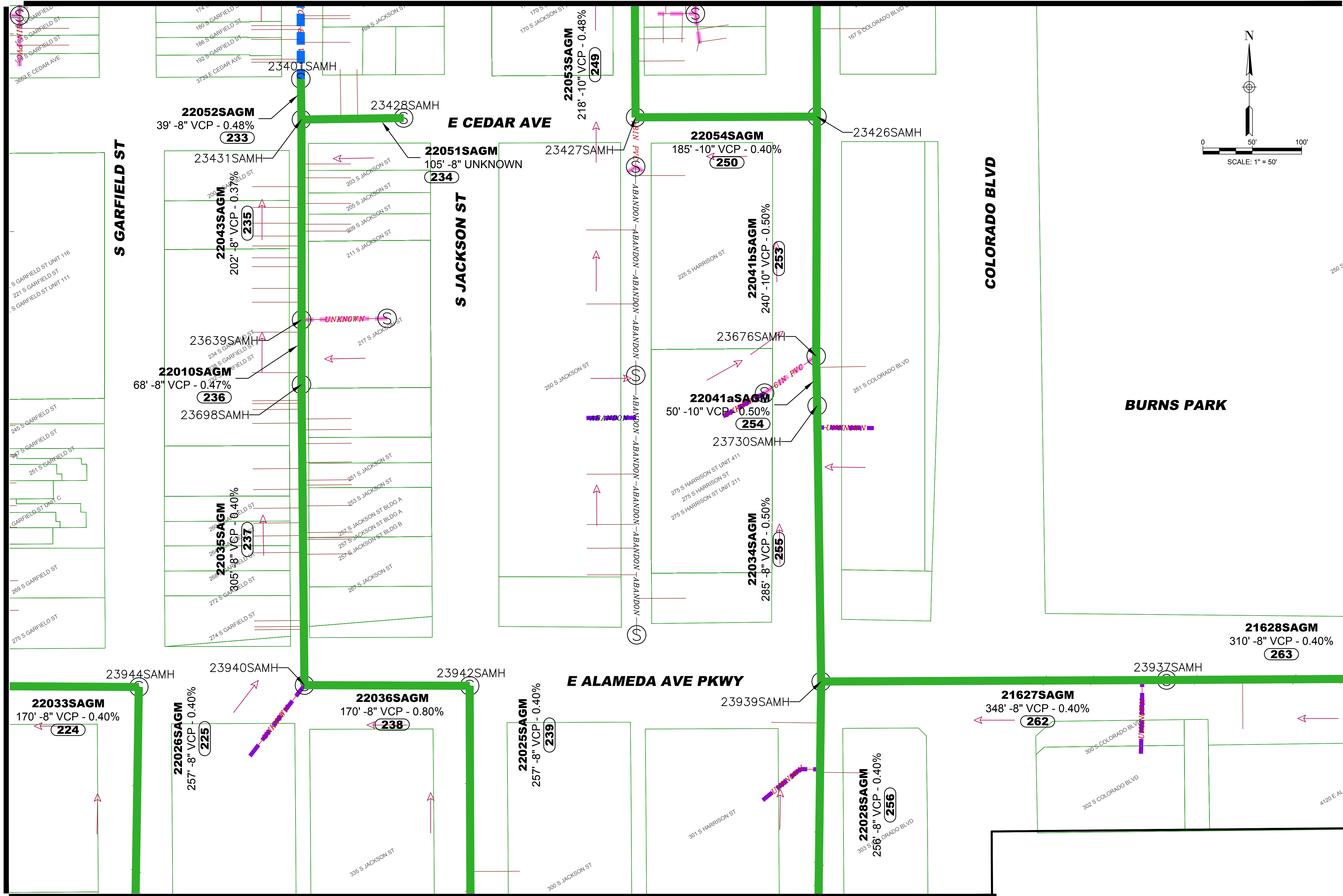

NO.	DESCRIPTION OF REVISIONS	DATE	BY

CALL UNCC  
TWO WORKING DAYS  
BEFORE YOU DIG  
1-800-422-1987  
UTILITY SERVICES CENTER  
COLORADO

CITY AND COUNTY OF DENVER  
DEPARTMENT OF PUBLIC WORKS  
ENGINEERING DIVISION  
CAPITAL PROJECTS MANAGEMENT  
2000 W. 3RD AVE. DENVER, CO 80223  
TEL.: (303) 446-3617 FAX: (303) 446-3647

CHERRY CREEK EAST SANITARY  
IMPROVEMENTS  
PRO TRACKING NO: PWWW2018-001  
PROJECT MASTER NO: 2018-PROJMSTR-0000089

DRAWN BY:	CJM
DESIGNED BY:	-
APPROVED BY:	JJC
DRAWING NAME:	Sheet 18.dwg
DATE:	04/20/2018
SHEET NO.:	18 OF 32

SHEET 18

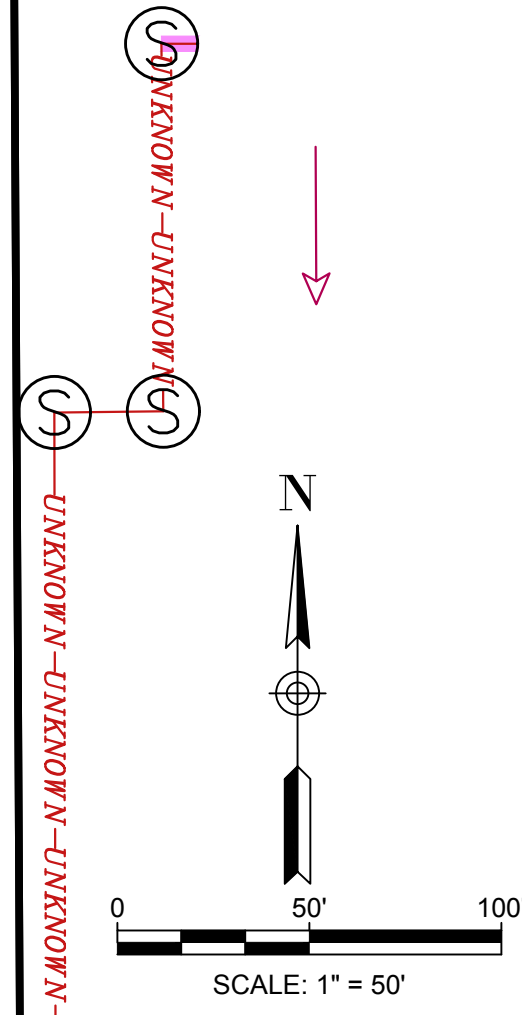
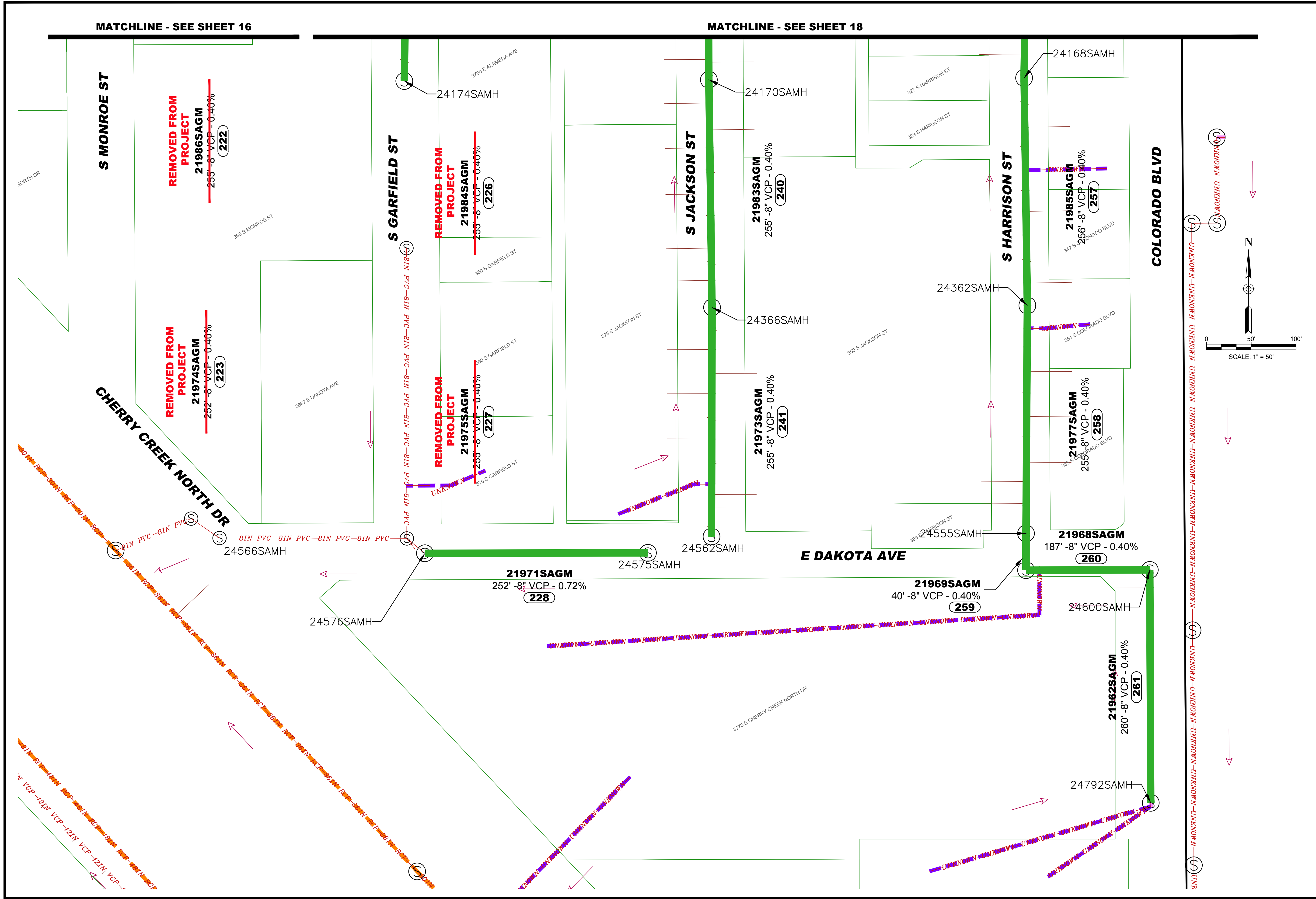

DESCRIPTION OF REVISIONS		DATE	BY
NO.			
<p>CALL UNCC TWO WORKING DAYS BEFORE YOU DIG 1-800-422-1987 UTILITY SUPERVISOR CENTER OF COLORADO</p> 			
<p>CITY AND COUNTY OF DENVER DEPARTMENT OF PUBLIC WORKS ENGINEERING DIVISION CAPITAL PROJECTS MANAGEMENT 2000 W. 3RD AVE. DENVER, CO 80223 TEL.: (303) 446-3617 FAX: (303) 446-3647</p>			
<p>CHERRY CREEK EAST SANITARY IMPROVEMENTS</p>			
<p>PRO TRACKING NO: PWWW2018-001 PROJECT MASTER NO: 2018-PROJMSTR-0000089</p>			
<p>SHEET 19</p>			
DRAWN BY:		CJM	
DESIGNED BY:		-	
APPROVED BY:		JJC	
DRAWING NAME:		Sheet 19.dwg	
DATE:		04/20/2018	
SHEET NO.:		19 OF 32	







PLOT DATE: May 25, 2018

S:\STAFF\_FOLDERS\CONLEY\UNINC\_PROJECTS\CHERRY\_CREEK\_EAST\SHEET 23.DWG

MATCHLINE - SEE SHEET 24

MATCHLINE - SEE SHEET 17

MATCHLINE - SEE SHEET 22

MATCHLINE - SEE SHEET 20

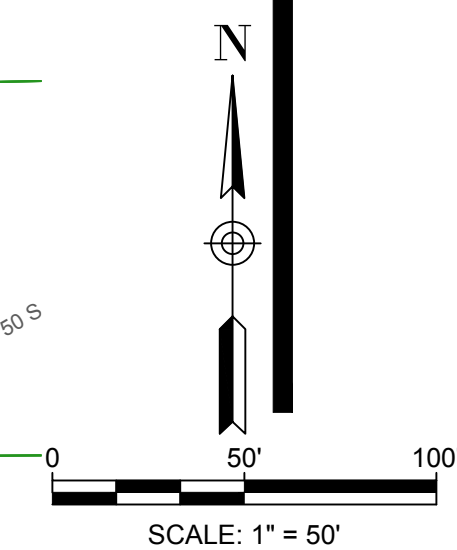
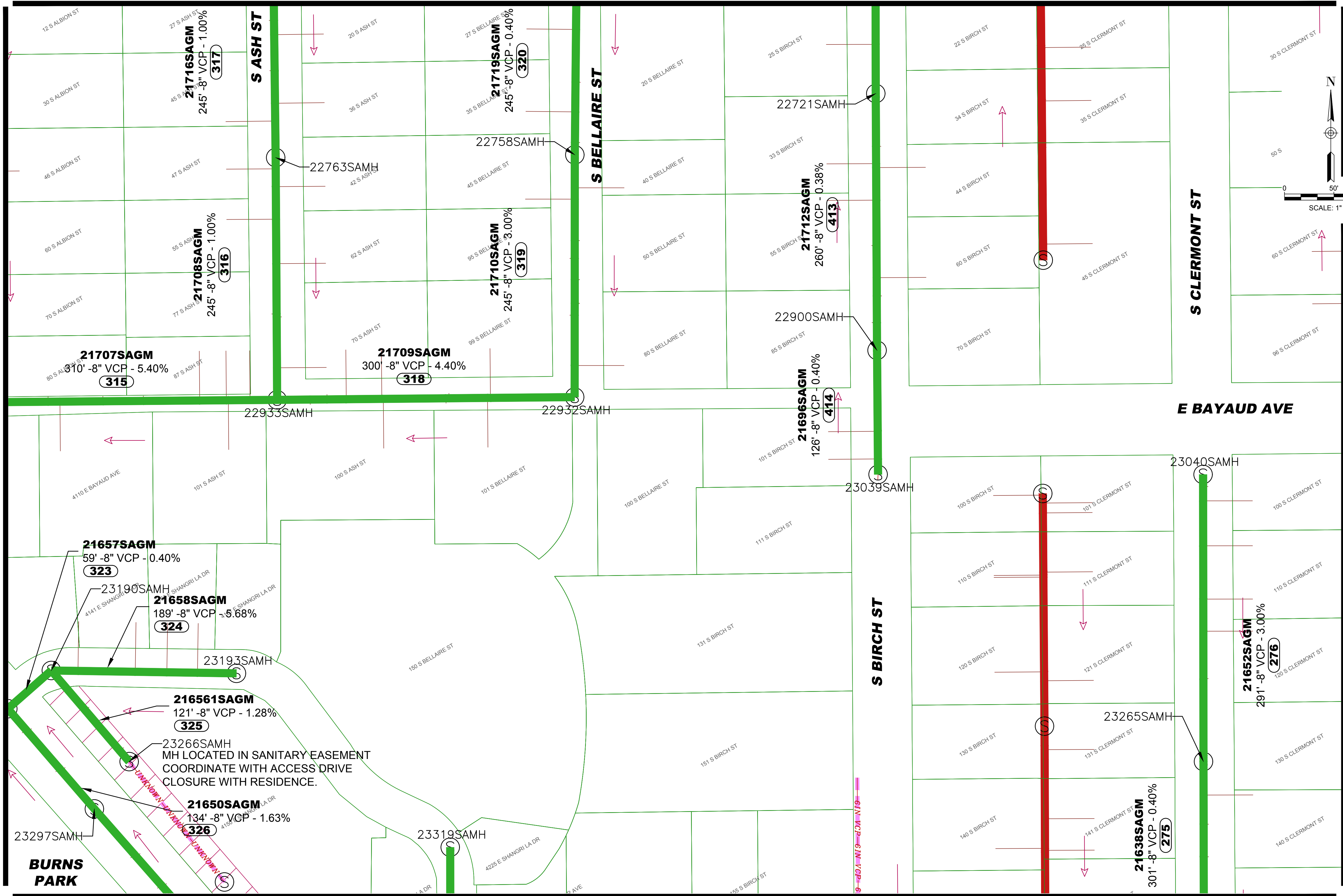

NO.	DESCRIPTION OF REVISIONS	DATE	BY

CALL UNCC  
TWO WORKING DAYS  
BEFORE YOU DIG  
1-800-422-1987  
UTILITY SERVICES CENTER OF  
COLORADO

CITY AND COUNTY OF DENVER  
DEPARTMENT OF PUBLIC WORKS  
ENGINEERING DIVISION  
CAPITAL PROJECTS MANAGEMENT  
2000 W. 3RD AVE. DENVER, CO 80223  
TEL.: (303) 446-3617 FAX: (303) 446-3647

CHERRY CREEK EAST SANITARY  
IMPROVEMENTS  
PRO TRACKING NO: PWWW2018-001  
PROJECT MASTER NO: 2018-PROJMSTR-0000089

DRAWN BY: CJM  
DESIGNED BY: -  
APPROVED BY: JJC  
DRAWING NAME: Sheet 23.dwg  
DATE: 04/20/2018  
SHEET NO.: 23 OF 32

SHEET 23

PLOT DATE: May 25, 2018

S:\STAFF\_FOLDERS\COCKELEY\LINING\CHERRY\_CREEK\_EAST\_SHEET\_24.DWG

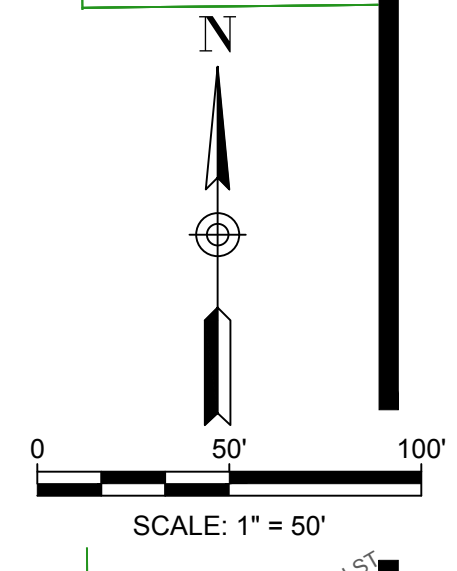
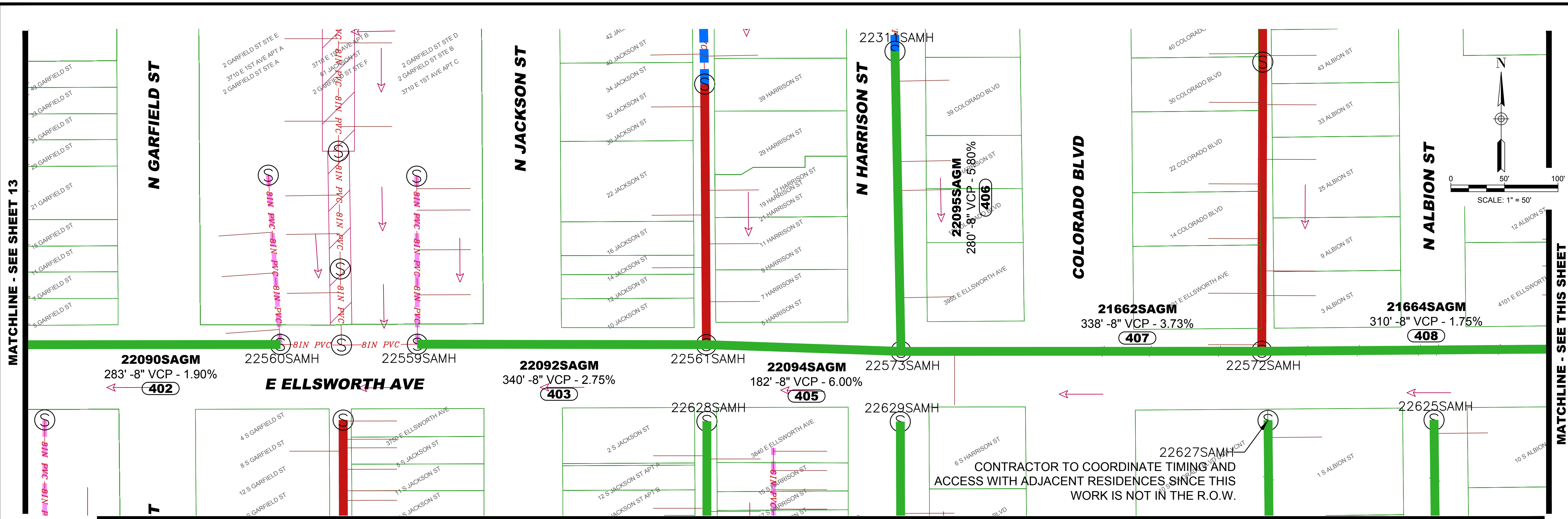

NO.	DESCRIPTION OF REVISIONS	DATE	BY

CALL UNCC  
TWO WORKING DAYS  
BEFORE YOU DIG  
1-800-422-1987  
UTILITY SERVICES CENTER OF  
COLORADO

CITY AND COUNTY OF DENVER  
DEPARTMENT OF PUBLIC WORKS  
ENGINEERING DIVISION  
CAPITAL PROJECTS MANAGEMENT  
2000 W. 3RD AVE. DENVER, CO 80223  
TEL.: (303) 446-3617 FAX: (303) 446-3647

CHERRY CREEK EAST SANITARY  
IMPROVEMENTS

PRO TRACKING NO: PWWW2018-001  
PROJECT MASTER NO: 2018-PROJMSTR-0000089

SHEET 24

DRAWN BY: CJM  
DESIGNED BY: -  
APPROVED BY: JJC  
DRAWING NAME: Sheet 24.dwg  
DATE: 04/20/2018  
SHEET NO.: 24 OF 32



PLOT DATE: May 25, 2018

S:\STAFF\_FOLDERS\COKELEY\LINING\_PROJECTS\CHERRY\_CREEK\_EAST\_SHEET\_25.DWG

MATCHLINE - SEE SHEET 32

MATCHLINE - SEE SHEET 22

MATCHLINE - SEE SHEET 24



NO.	DESCRIPTION OF REVISIONS	DATE	BY

CALL UNCC  
TWO WORKING DAYS  
BEFORE YOU DIG  
1-800-422-1987  
UTILITY SUPERVISOR CENTER OF  
COLORADO



CITY AND COUNTY OF DENVER  
DEPARTMENT OF PUBLIC WORKS  
ENGINEERING DIVISION  
CAPITAL PROJECTS MANAGEMENT  
2000 W. 3RD AVE. DENVER, CO 80223  
TEL.: (303) 446-3617 FAX: (303) 446-3647

CHERRY CREEK EAST SANITARY  
IMPROVEMENTS  
PRO TRACKING NO: PWWW2018-001  
PROJECT MASTER NO: 2018-PROJMSTR-0000089

DRAWN BY:	CJM
DESIGNED BY:	-
APPROVED BY:	JJC
DRAWING NAME:	Sheet 25.dwg
DATE:	04/20/2018
SHEET NO.:	25 OF 32

SHEET 25

PLOT DATE: May 25, 2018

S:\STAFF\_FOLDERS\COKELEY\UNINC\_PROJECTS\CHERRY\_CREEK\_EAST\_SHEET\_26.DWG

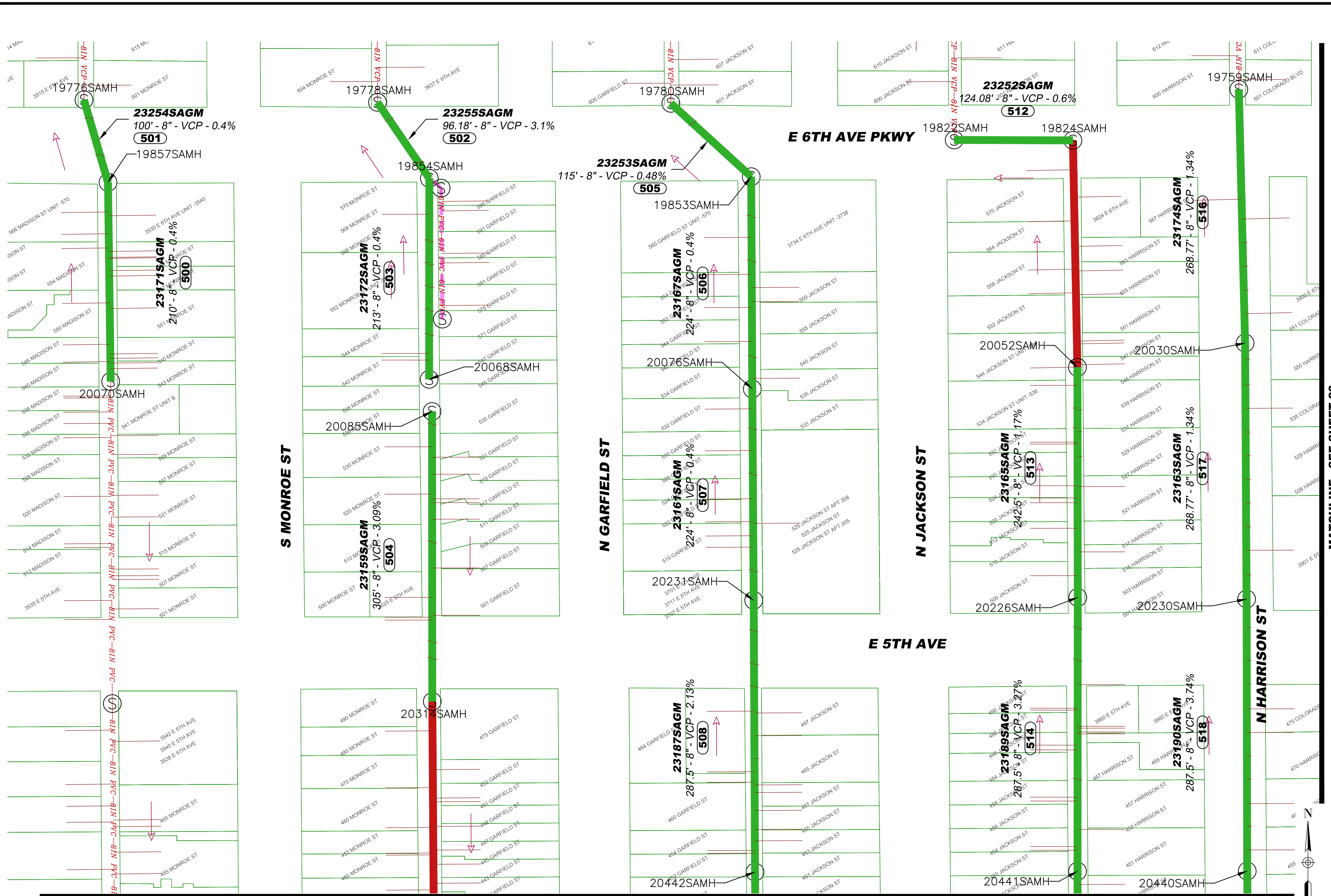

MATCHLINE - SEE SHEET 27

MATCHLINE - SEE SHEET 28

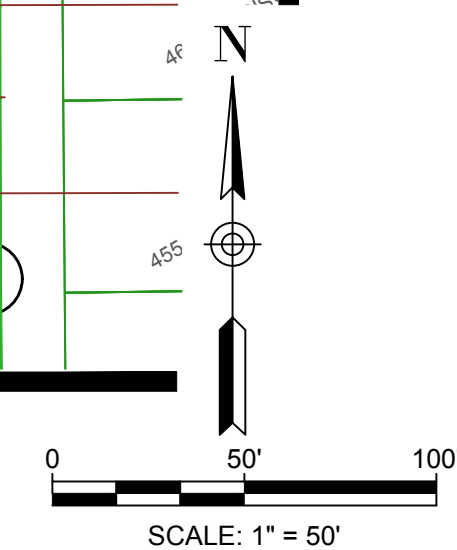

NO.	DESCRIPTION OF REVISIONS	DATE	BY

CALL UNCC  
TWO WORKING DAYS  
BEFORE YOU DIG  
1-800-422-1987  
UTILITY INFORMATION CENTER OF  
COLORADO



CITY AND COUNTY OF DENVER  
DEPARTMENT OF PUBLIC WORKS  
ENGINEERING DIVISION  
CAPITAL PROJECTS MANAGEMENT  
2000 W. 3RD AVE. DENVER, CO 80223  
TEL.: (303) 446-3617 FAX: (303) 446-3647

CHERRY CREEK EAST SANITARY  
IMPROVEMENTS

PRO TRACKING NO: PWWW2018-001  
PROJECT MASTER NO: 2018-PROJMSTR-0000089

DRAWN BY: CJM  
DESIGNED BY: -  
APPROVED BY: JJC  
DRAWING NAME: Sheet 26.dwg  
DATE: 04/20/2018  
SHEET NO.: 26 OF 32

SHEET 26



PLOT DATE: May 25, 2018

S:\STAFF\_FOLDERS\COKELEY\LINING\_PROJECTS\CO\CHERRY\_CREEK\EAST\SHEET 28.DWG

MATCHLINE - SEE SHEET 26

MATCHLINE - SEE SHEET 29

E 6TH AVE PKWY

E 6TH AVE PKWY

COLORADO BLVD

N ALBION ST

N ASH ST

N BELLAIRE ST

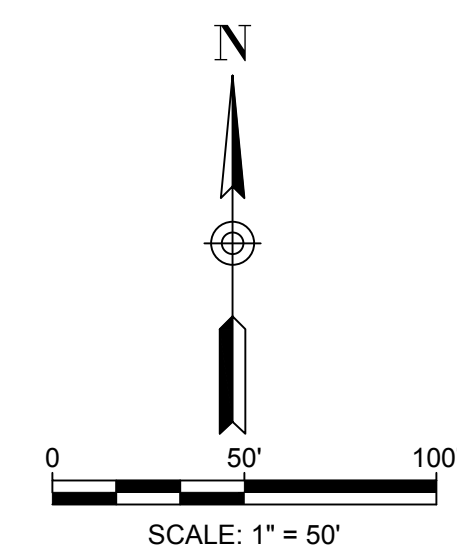
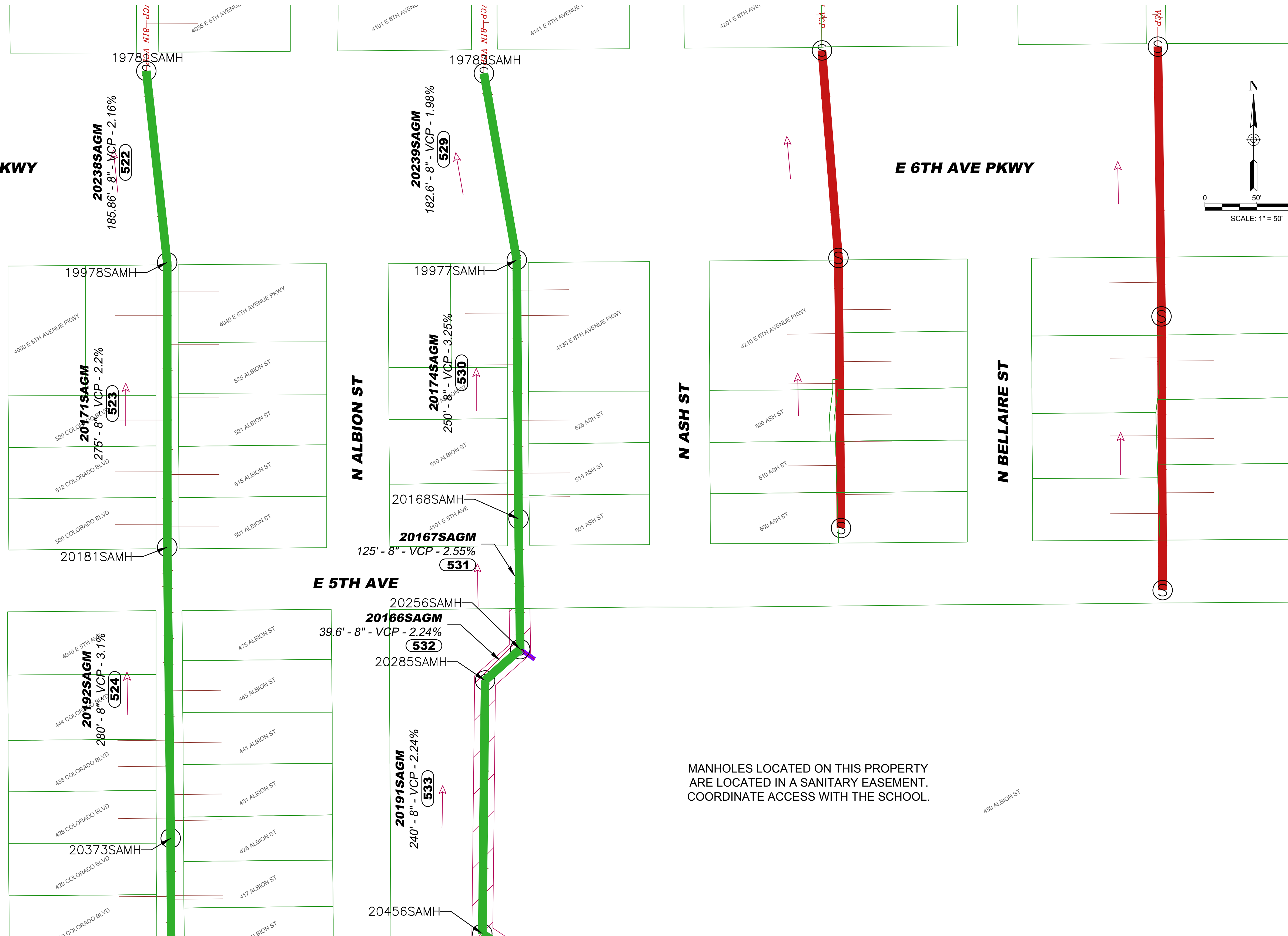

MANHOLES LOCATED ON THIS PROPERTY ARE LOCATED IN A SANITARY EASEMENT. COORDINATE ACCESS WITH THE SCHOOL.

NO.	DESCRIPTION OF REVISIONS	DATE	BY

CALL UNCC  
TWO WORKING DAYS  
BEFORE YOU DIG  
1-800-422-1987  
UTILITY SUPERVISOR CENTER OF  
COLORADO

CITY AND COUNTY OF DENVER  
DEPARTMENT OF PUBLIC WORKS  
ENGINEERING DIVISION  
CAPITAL PROJECTS MANAGEMENT  
2000 W. 3RD AVE. DENVER, CO 80223  
TEL.: (303) 446-3617 FAX: (303) 446-3647

CHERRY CREEK EAST SANITARY  
IMPROVEMENTS  
PRO TRACKING NO: PWWW2018-001  
PROJECT MASTER NO: 2018-PROJMSTR-0000089

DRAWN BY:	CJM
DESIGNED BY:	-
APPROVED BY:	JJC
DRAWING NAME:	Sheet 28.dwg
DATE:	04/20/2018
SHEET NO.:	28 OF 32

SHEET 28

PLOT DATE: May 25, 2018

S:\STAFF\_FOLDERS\COKELEY\UNINC\_PROJECTS\CHERRY\_CREEK\EAST\_SHEET\_29.DWG

MATCHLINE - SEE SHEET 27

MATCHLINE - SEE SHEET 28

COLORADO BLVD

E 4TH AVE

N ALBION ST

N ASH ST

N BELLAIRE ST

N BIRCH ST

E 3RD AVE

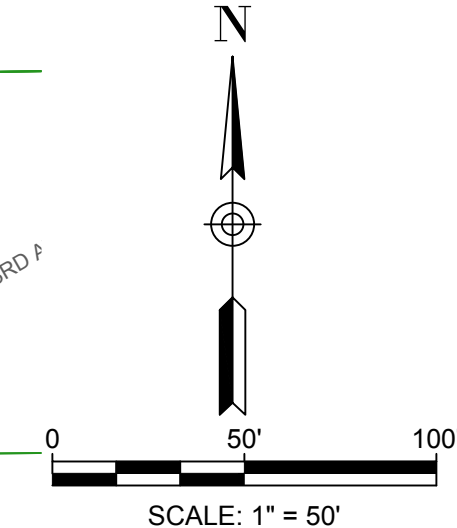
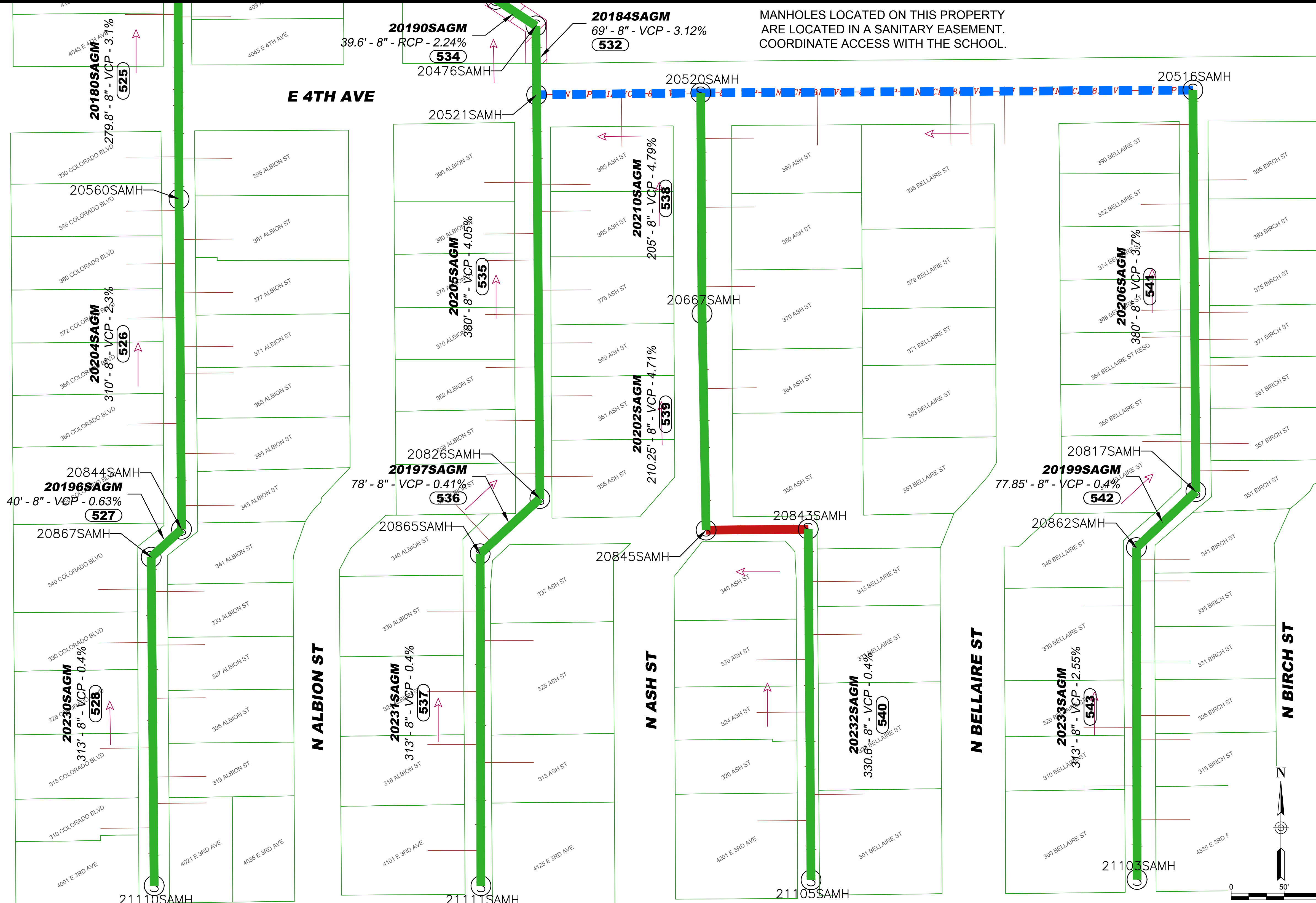

NO.	DESCRIPTION OF REVISIONS	DATE	BY

CALL UNCC  
TWO WORKING DAYS  
BEFORE YOU DIG  
1-800-422-1987  
UTILITY OPERATIONS CENTER OF  
COLORADO

CITY AND COUNTY OF DENVER  
DEPARTMENT OF PUBLIC WORKS  
ENGINEERING DIVISION  
CAPITAL PROJECTS MANAGEMENT  
2000 W. 3RD AVE. DENVER, CO 80223  
TEL.: (303) 446-3617 FAX: (303) 446-3647

CHERRY CREEK EAST SANITARY  
IMPROVEMENTS  
PRO TRACKING NO: PWWW2018-001  
PROJECT MASTER NO: 2018-PROJMSTR-0000089

DRAWN BY:	CJM
DESIGNED BY:	-
APPROVED BY:	JJC
DRAWING NAME:	Sheet 29.dwg
DATE:	04/20/2018
SHEET NO.:	29 OF 32

SHEET 29

PLOT DATE: May 25, 2018

S:\STAFF\_FOLDERS\COKELEY\UNING\_PROJECTS\CHERRY\_CREEK\EAST\SHEET\_30.DWG

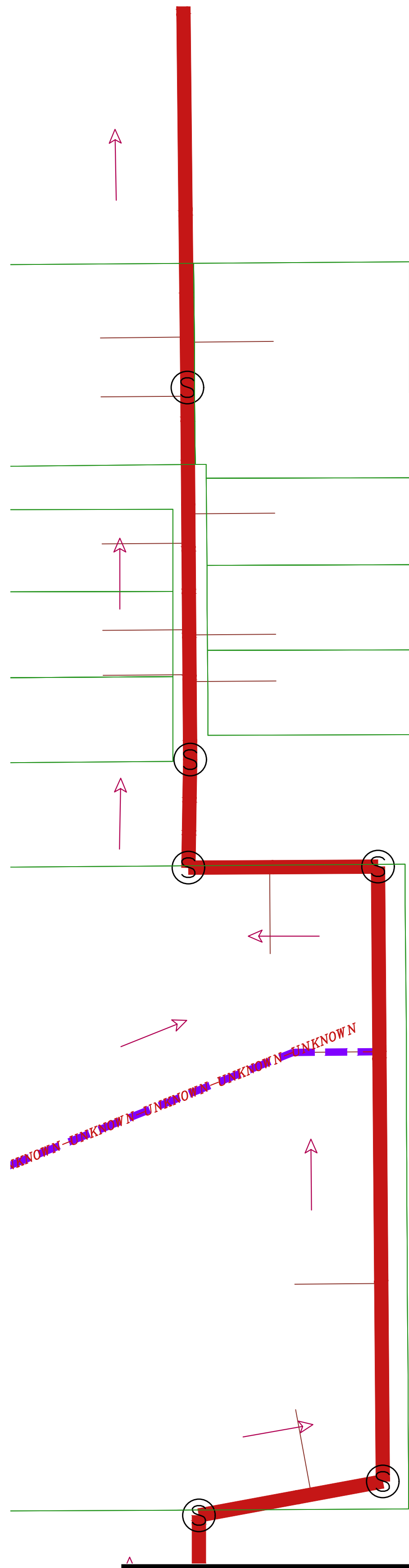

**E 6TH AVE PKWY**

**N CLERMONT ST PKWY**

**E 5TH AVE**

**E 4TH AVE**

**N DEXTER ST**

**N DAHLIA ST**

**20241SAGM**  
155' - 8" - VCP - 0.4%  
(547)

**20242SAGM**  
310' - 8" - VCP - 0.5%  
(546)

**20175SAGM**  
293' - 8" - VCP - 2.65%  
(548)

**20193SAGM**  
290' - 8" - VCP - 2.6%  
(549)

**20182SAGM**  
289.6' - 8" - VCP - 2.4%  
(550)

**20281SAGM**  
265' - 8" - VCP - 2.4%  
(555)

**20275SAGM**  
265' - 8" - VCP - 2.4%  
(556)

**20289SAGM**  
264.7' - 8" - VCP - 2%  
(557)

19945SAMH

19940SAMH

19937SAMH

20162SAMH

20363SAMH

20291SAMH

20479SAMH

1984 SAMH

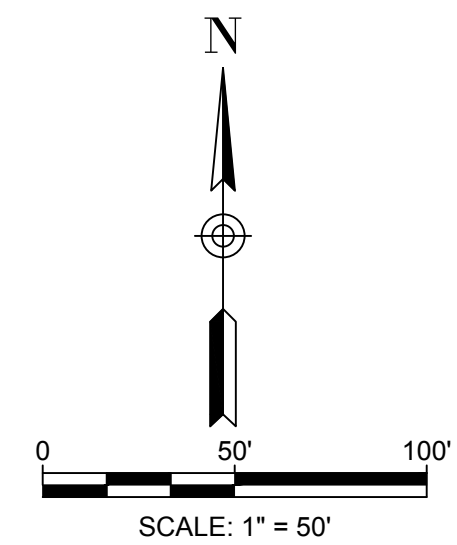

CONTRACTOR TO COORDINATE TIMING AND ACCESS WITH ADJACENT RESIDENCES SINCE THIS WORK IS NOT IN THE R.O.W.

**MATCHLINE - SEE SHEET 31**

NO.	DESCRIPTION OF REVISIONS	DATE	BY

CALL UNCC  
TWO WORKING DAYS  
BEFORE YOU DIG  
1-800-422-1987  
UTILITY SUPERVISOR CENTER  
OF COLORADO

CITY AND COUNTY OF DENVER  
DEPARTMENT OF PUBLIC WORKS  
ENGINEERING DIVISION  
CAPITAL PROJECTS MANAGEMENT  
2000 W. 3RD AVE. DENVER, CO 80223  
TEL.: (303) 446-3617 FAX: (303) 446-3647

**CHERRY CREEK EAST SANITARY IMPROVEMENTS**  
PRO TRACKING NO: PWWW2018-001  
PROJECT MASTER NO: 2018-PROJMSTR-0000089

DRAWN BY:	CJM
DESIGNED BY:	-
APPROVED BY:	JJC
DRAWING NAME:	Sheet 30.dwg
DATE:	04/20/2018
SHEET NO.:	30 OF 32

SHEET 30

PLOT DATE: May 25, 2018

S:\STAFF\_FOLDERS\COKELEY\PROJECTS\CO\CHERRY\_CREEK\_EAST\SHEET\_31.DWG

MATCHLINE - SEE SHEET 30

E 4TH AVE

MATCHLINE - SEE SHEET 32

E 3RD AVE

N CLERMONT ST PKWY

N DEXTER ST

N DAHLIA ST

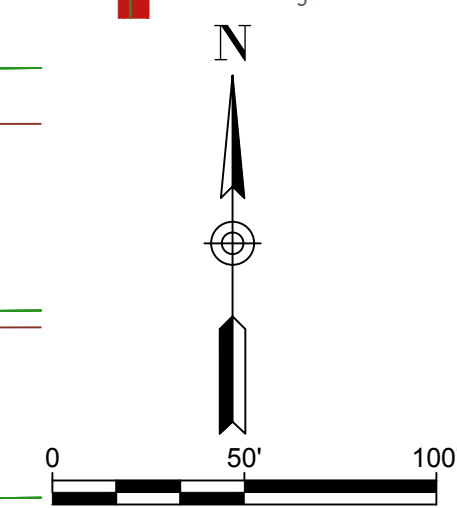
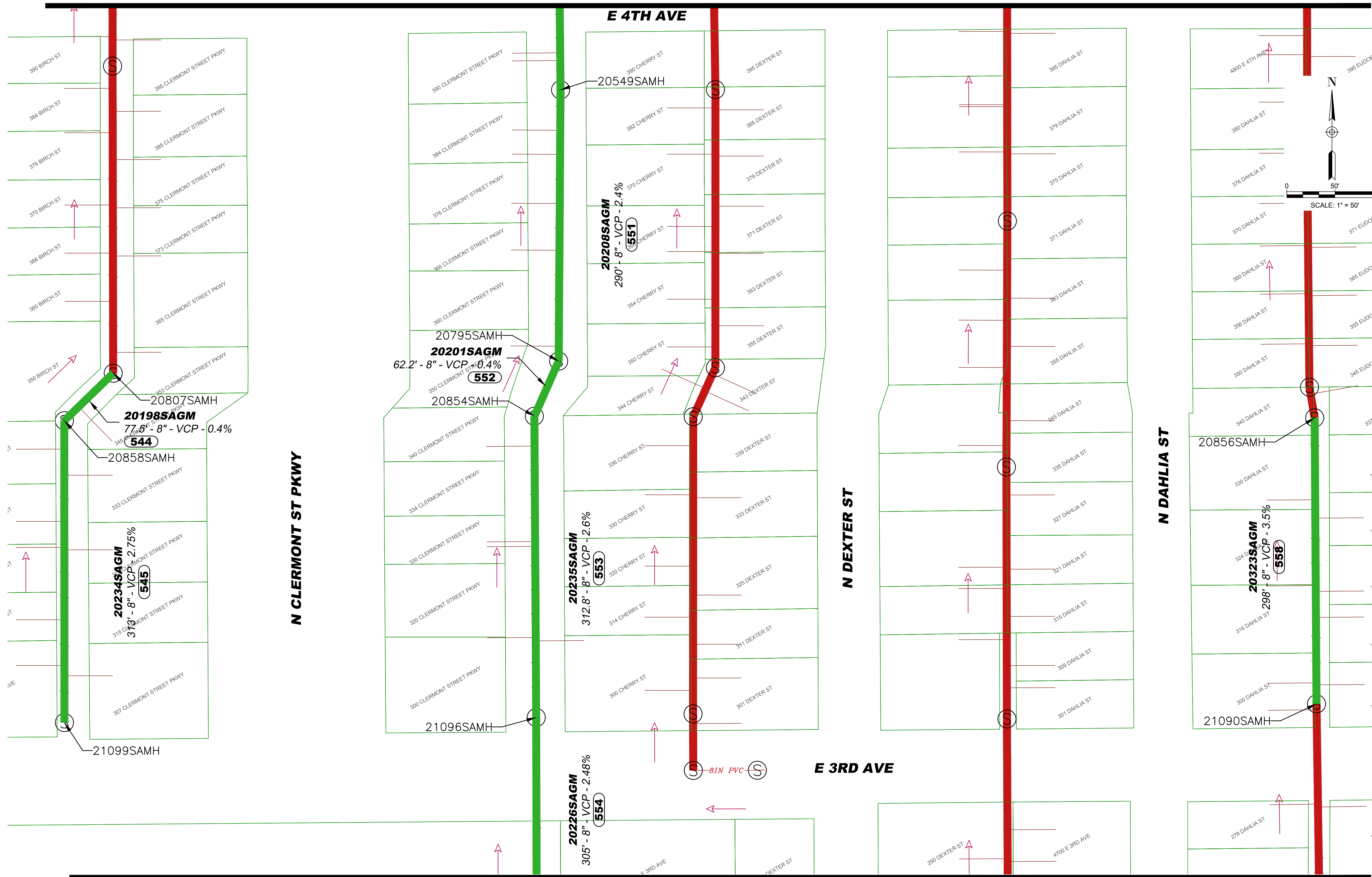

NO.	DESCRIPTION OF REVISIONS	DATE	BY

CALL UNCC  
TWO WORKING DAYS  
BEFORE YOU DIG  
1-800-422-1987  
UTILITY SERVICES CENTER OF  
COLORADO

CITY AND COUNTY OF DENVER  
DEPARTMENT OF PUBLIC WORKS  
ENGINEERING DIVISION  
CAPITAL PROJECTS MANAGEMENT  
2000 W. 3RD AVE. DENVER, CO 80223  
TEL.: (303) 446-3617 FAX: (303) 446-3647

CHERRY CREEK EAST SANITARY  
IMPROVEMENTS  
PRO TRACKING NO: PWWW2018-001  
PROJECT MASTER NO: 2018-PROJMSTR-0000089

DRAWN BY: CJM  
DESIGNED BY: -  
APPROVED BY: JJC  
DRAWING NAME: Sheet 31.dwg  
DATE: 04/20/2018  
SHEET NO.: 31 OF 32

SHEET 31

MATCHLINE - SEE SHEET 31

MATCHLINE - SEE SHEET 25

4440 E 3RD AVE

CRANMER PARK

N MONUMENT - N MONUMENT

21375SAMH  
SEE CONSTRUCTION  
NOTE 15

21516SAMH  
20220SAGM  
155.5' - 8" - VCP - 0.4%  
(560)

21595SAMH  
20221SAGM  
174.5' - 8" - VCP - 0.4%  
(559)

20216SAGM  
246.61' - 8" - VCP - 0.8%  
(560)

20163SAGM  
285.2' - 8" - VCP - 0.4%  
(560)

21786SAMH

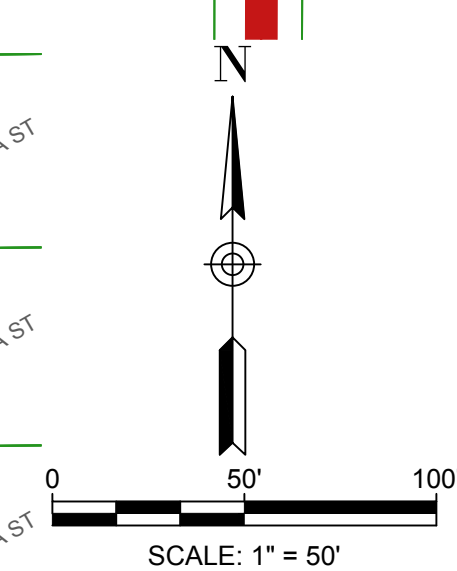

NO.	DESCRIPTION OF REVISIONS	DATE	BY

CALL UNCC  
TWO WORKING DAYS  
BEFORE YOU DIG  
1-800-422-1987  
UTILITY SUPERVISOR CENTER  
COLORADO

CITY AND COUNTY OF DENVER  
DEPARTMENT OF PUBLIC WORKS  
ENGINEERING DIVISION  
CAPITAL PROJECTS MANAGEMENT  
2000 W. 3RD AVE. DENVER, CO 80223  
TEL.: (303) 446-3617 FAX: (303) 446-3647

CHERRY CREEK EAST SANITARY  
IMPROVEMENTS  
PRO TRACKING NO: PWWW2018-001  
PROJECT MASTER NO: 2018-PROJMSTR-0000089  
SHEET 32

DRAWN BY: CJM  
DESIGNED BY: -  
APPROVED BY: JJC  
DRAWING NAME: Sheet 32.dwg  
DATE: 04/20/2018  
SHEET NO.: 32 OF 32