



2024 Bundle Text Amendment

Land Use, Transportation & Infrastructure Committee
Action Item – November 12, 2024

Alek Miller, AICP, Senior City Planner
Tina Axelrad, Zoning Administrator

What is the Text Amendment Bundle?

- Every few years, CPD proposes a “bundle” of text amendments to the Denver Zoning Code to reduce ambiguity, simplify standards, comply with state law, clean up errors, and revisit requirements.
- Ensures the Denver Zoning Code continues to respond to the needs of the city, while remaining modern and flexible.
- This year, the bundle includes more than 130 proposed changes to the Denver Zoning Code, including changes that CPD predicts could reduce plan review time and simplify code enforcement.

CUT PERMITTING TIME

Re-envision the development permitting process and reduce city review time by 30% by Dec. 31, 2024.

Objectives

1. Correct, Clarify, and Align

Clarify and simplify requirements

Align with other city and state policies

2. Reduce Permitting Times

Reevaluate what requires a zoning permit and whether regulations are achieving desired built outcomes for the time/effort required

3. Advance other City-adopted land use policies

Ask if regulations are advancing other city land use policies and objectives

Where do proposed changes come from?

- Data (e.g., adjustment and variance requests)
- Applicants
- Staff in CPD
- City policy guidance and state law

Themes



Three themes emerged from our work to achieve the objectives:

- Equitable Treatment Under the Denver Zoning Code
- Better Design Outcomes, Less Time in Review
- Simpler Standards, Quicker Reviews

Equitable Treatment Under the Denver Zoning Code

Removing barriers to physical accessibility

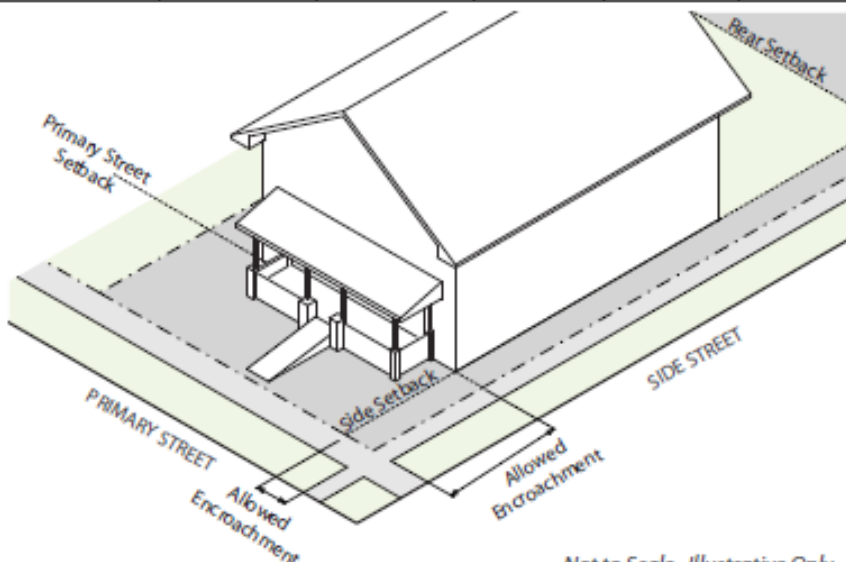
- Allow barrier-free access structures as a setback exception for existing and new buildings
- Match or exceed the many exceptions for stairs in DZC

	ZONE DISTRICTS	BUILDING FORMS	PRIMARY STREET	SIDE STREET	SIDE INTERIOR	REAR
<p>Barrier-free access structures providing access to existing buildings, when no alternative location is available.</p> <p>• Setback encroachments for barrier-free access structures are only allowed for expansions, enlargements, and alterations to existing buildings.</p>	All S- Zone Districts	All Building Forms	Any distance	Any distance	Any distance	Any distance
<p>Intent: To provide flexibility in the location of barrier-free access <u>structures, to existing buildings.</u></p>						
 <p><i>Illustrative only</i></p>						

Equitable Treatment Under the Denver Zoning Code

No Longer Regulating Relationships Between People

- Combine use definitions of Non-Profit Housekeeping Unit and Household in 11.12.2.1.B.2 and 3
- Eliminate references to relationship by blood, marriage, civil union, etc.
- Implement new state law

New Household Definition:

A “household” is any number of persons, plus any permitted domestic service workers, who all occupy a Dwelling Unit who share household activities and responsibilities, such as meals, chores, rent, and expenses. The choice of specific adults comprising the household is determined by the members of such household rather than by a landlord, property manager, or other third party. Members are not required to seek services or care of any type as a condition of residency. All members of the household jointly occupy the entire premises of the dwelling unit.

Equitable Treatment Under the Denver Zoning Code

Carriage Lot Development

ALLOWED USE OF A CARRIAGE LOT

- Until 2010, could only be used for vehicle parking and garages. Applicant for a use permit had to be the owner of the carriage lot, or portion thereof, and have their principal residence on the block surrounding the carriage lot. Former Chapter 59, Sec. 59-38(a)(16)
- In 2010, rights expanded to include an **accessory dwelling unit (ADU)** and **accessory garden** – carried forward the requirement that the applicant had to be the owner of the carriage lot and had to have their “primary residence” on the surrounding block. The zoning permit is personal to the applicant.

Equitable Treatment Under the Denver Zoning Code

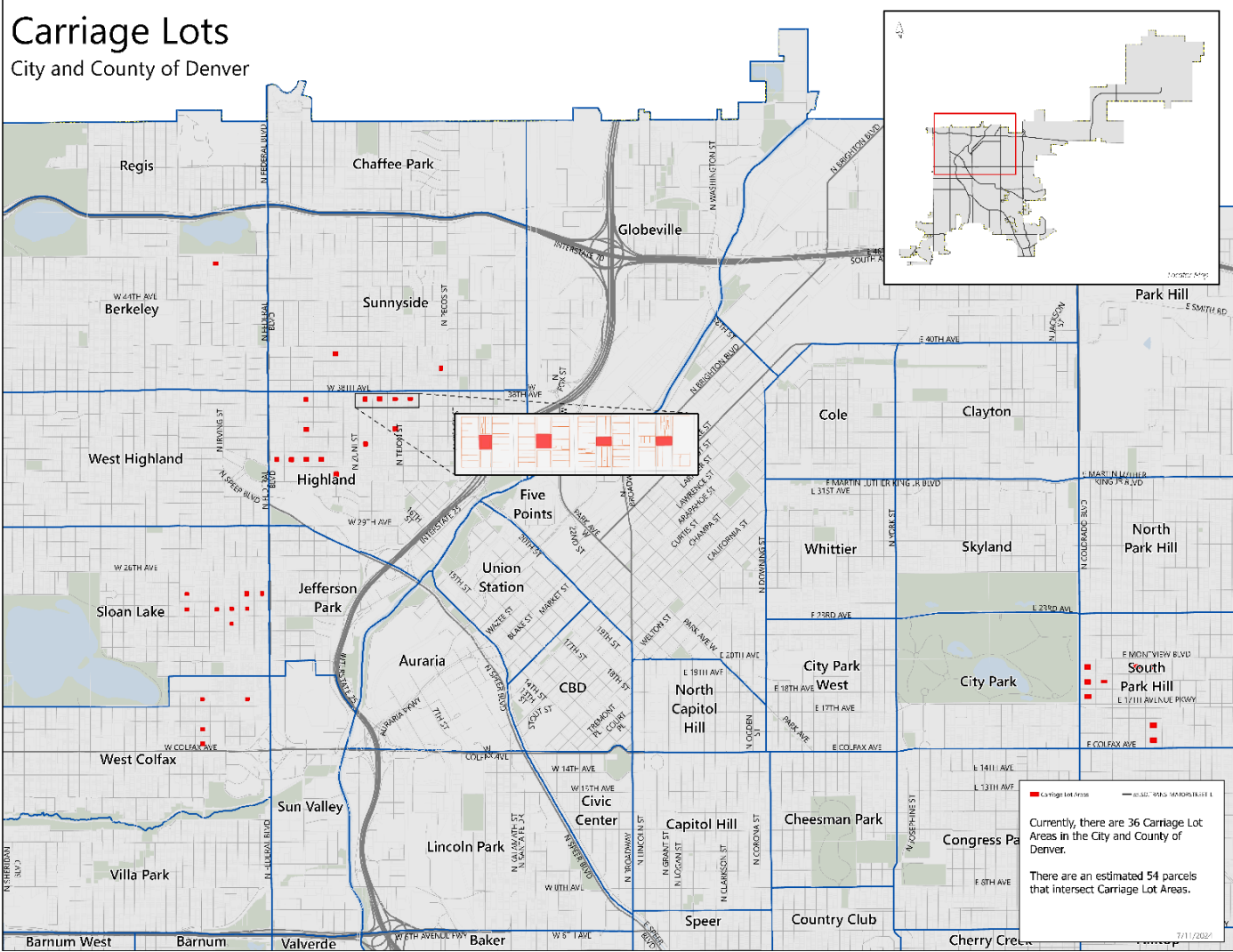

Carriage Lot Development

- 36 carriage lots in Denver
- 54 parcels contained in those 36 carriage lots
- 7 vacant carriage lots per Denver County Assessor tax records
- Located in low-density residential zones = SU, TU

Equitable Treatment Under the Denver Zoning Code

Carriage Lot Development – Changes Proposed

- | | |
|---|-----------|
| <input type="checkbox"/> Allowed Uses? | EXPANDED |
| <input type="checkbox"/> Primary residence on the block requirement? | REMOVED |
| <input type="checkbox"/> Density? | NO CHANGE |
| <input type="checkbox"/> Structure – size, footprint, height? | NO CHANGE |
| <input type="checkbox"/> Use review for a new zoning permit (ZPIN)? | NO CHANGE |
| <input type="checkbox"/> Multi-agency review of development on a carriage lot? | NO CHANGE |
| <input type="checkbox"/> Issued zoning permit personal to the original permittee? | REMOVED |

Equitable Treatment Under the Denver Zoning Code

Why these changes are being made

Remove the owner-must-have-primary-residence-on-the-block requirement and the limit that an approved zoning permit remain personal to the original permittee:

- Advance more equitable opportunities to access housing and to engage in development
- Advance zoning reform by removing standards/limits that regulates the “who” vs. the “what” = land uses, structures, building and urban design. Text amendments propose removal of all “personal to applicant” limits on zoning permits – more than just carriage lot provision.
- Remove irrational bias in the zoning code** – no rational basis for assuming a carriage lot owner who lives on the same block guarantees a different or better outcome than if the owner lives off the block. ~Treat similarly to other residential property in city.
~Prevent significant market constraints and legal issues that occur if the current ownership/residency requirement is violated.

Better Design Outcomes, Less Time in Review

Elimination of Parking Requirements in D-LD (8.4.1.4)

- Subject of multiple recent variances
- Proposal supports plan guidance to create walkable urban development in Downtown.
- Aligns with other Downtown Districts (Downtown Core and Downtown Theatre Districts)

Simplification of Parking Calculation for Expansions/Changes of Use (10.4.2.3.B)

- Calculations based on a GFA increase vs. on a required parking amount increase

Better Design Outcomes, Less Time in Review

Transparency Alternatives (13.1.6.3.A.5.a – c)

Removal of display cases, Automated Teller Machines, and Wall Design Elements as alternatives to transparency

- Focus alternatives to transparency on design elements that best generate pedestrian interest – at least as equally to windows

Figure 13.1-108

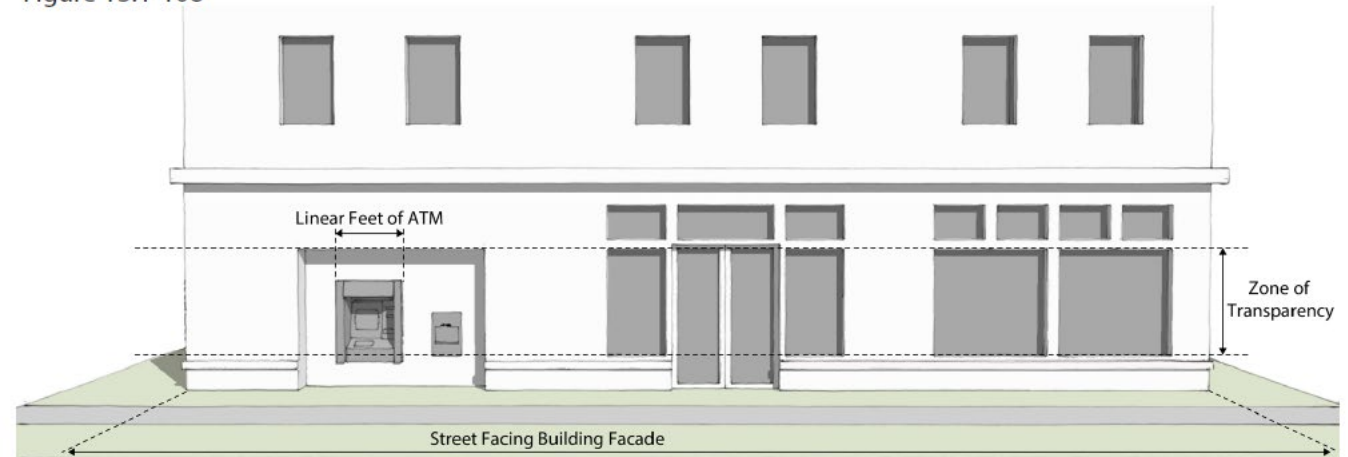

Not to Scale. Illustrative Only.

Better Design Outcomes, Less Time in Review

Transparency Alternatives (13.1.6.3.A.5.a – c)

Remaining Alternatives to Transparency

- Permanent Art
- Permanent Outdoor Gathering Areas



Simpler Standards, Quicker Reviews

DZC Today

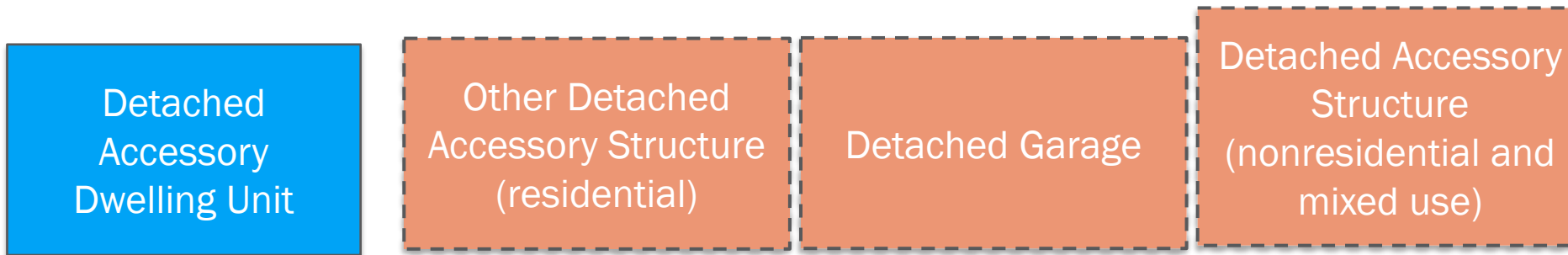

Bundle

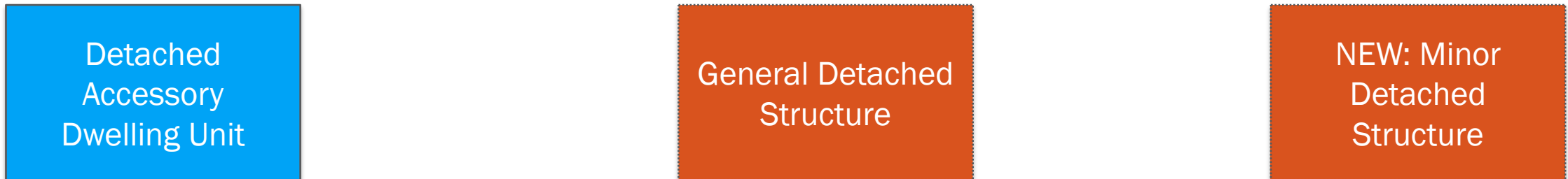

Minor Detached Structure Building Form

Option A: Located Anywhere on Lot

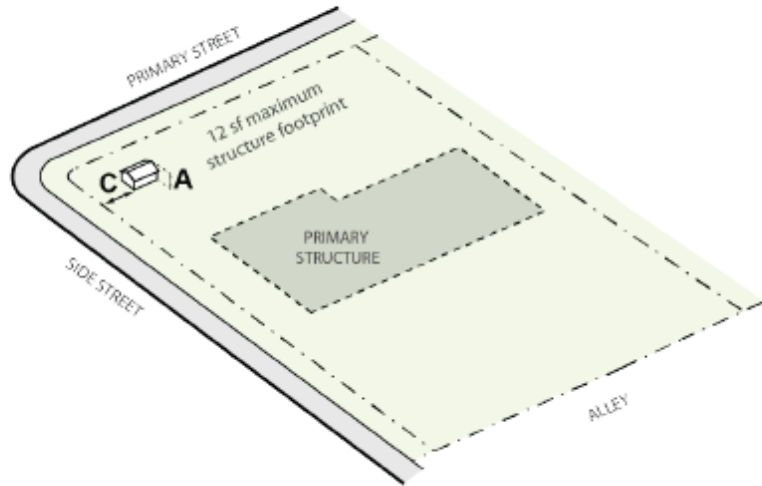

Option B: Located Behind Primary Street-Facing Facade

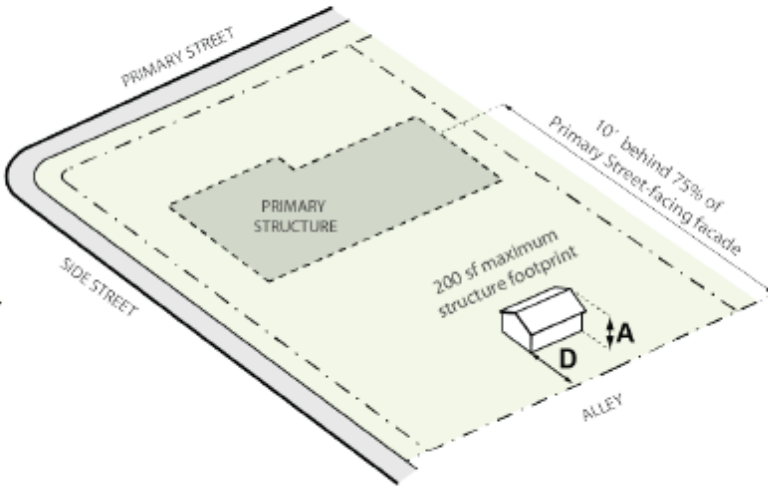

New building form proposed for minor structures such as planters, sheds, etc.

	All U-SU, TU, RH, RX, MX, MS Districts	
	Option A	Option B
<u>Structure footprint (max)</u>	12 sf	200 sf

DESIGN ELEMENTS

BUILDING CONFIGURATION

Structure footprint (max)

Minor Detached Structure Building Form

- Align with building code, which exempts structures from building permit within same parameters as Option B
- Apply setbacks across districts
- No Zoning Permit required

All U-SU, TU, RH, RX, MX, MS Districts		
HEIGHT	Option A*	Option B*
A <u>Stories (max)</u>	1	1
A <u>Feet (max)</u>	4'	14'

All U-SU, TU, RH, RX, MX, MS Districts		
SITING	Option A	Option B
<u>Total number of each structure (max)</u>	na	na
C LOCATION OF STRUCTURE		
<u>Ground-Mounted Mechanical Equipment</u>	<u>Shall be located a minimum of 10' behind 75% of the total width of the Primary Street-facing Façade**</u>	<u>Shall be located a minimum of 10' behind 75% of the total width of the Primary Street-facing Façade**</u>
<u>Utility Equipment</u>	<u>Allowed anywhere on the Zone Lot</u>	<u>Allowed anywhere on the Zone Lot</u>
<u>All Others</u>	<u>Allowed anywhere on the Zone Lot</u>	<u>Allowed anywhere on the Zone Lot</u>
SETBACKS		
B <u>Side Street (min)</u>	5'	5'
D <u>Side Interior, for structure entirely in rear 35% of zone lot (min)</u>	0'	0'
D <u>Side Interior, for structure not entirely in rear 35% of zone lot (min)</u>	5'	5'
<u>Rear, where no Alley (public or private) abuts Rear Zone Lot Line (min)</u>	5'	5'
E <u>Rear, where Alley (public or private) abuts Rear Zone Lot Line (min)</u>	0'	0'
<u>Building Coverage (max)</u>	<u>See maximum Building Coverage per Zone Lot in the Primary Structure building form table.</u>	

Simpler Standards, Quicker Reviews

- Refocus zoning permit requirements on what matters, align with building code where possible (including exemptions for small structures, swing sets, tree houses)
- Clarify when Landmark reviews are needed

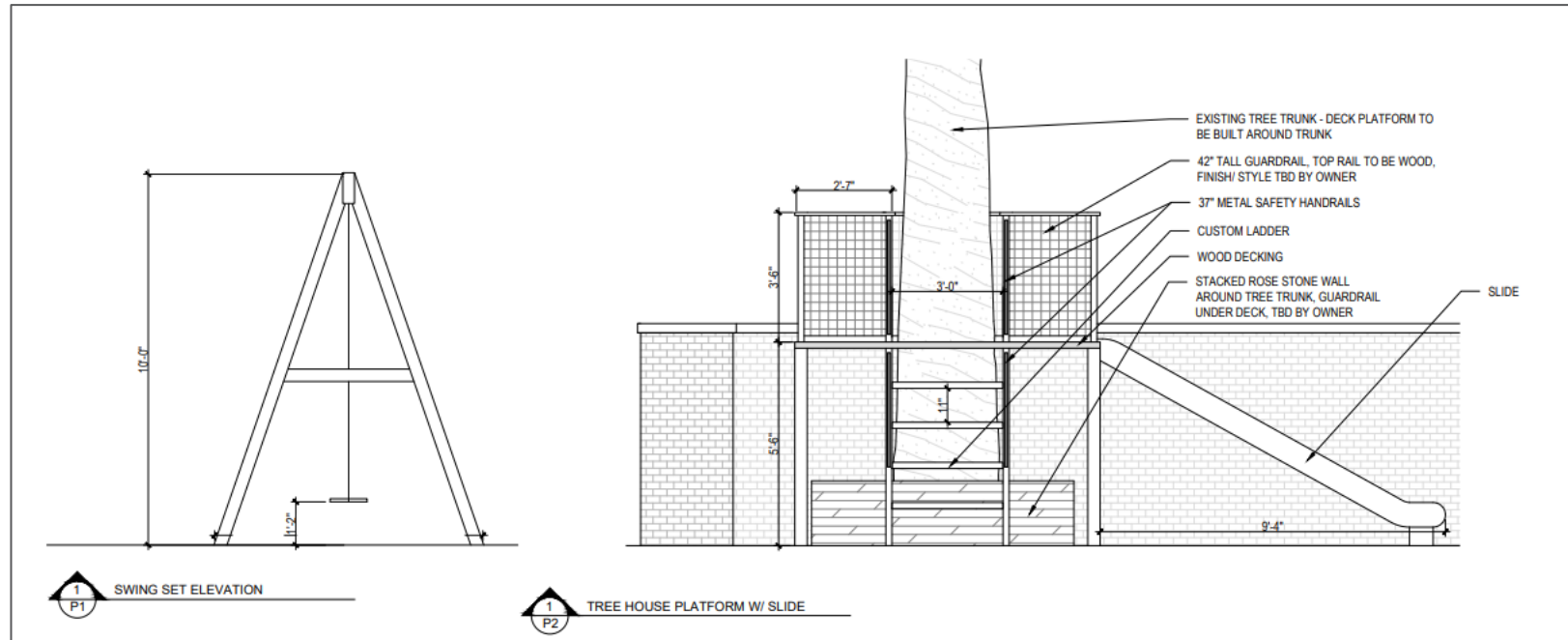

Simpler Standards, Quicker Reviews

Building Coverage

- Intended to maintain the amount of a zone lot that gets covered with structures, but simplify standards by removing exceptions
- Increase the base percentage, remove exceptions (but keep the front porch exception for better urban design outcomes)
- Exceptions removed (examples from Urban Context, Art 5):
 - Detached Garage – 500 sf if 80% of street level is used for vehicle parking and 15-foot separation between portions 30 inches above grade
 - Detached ADU – 500 sf with 15-foot separation between portions 30 inches above grade

SETBACKS AND BUILDING COVERAGE BY ZONE LOT WIDTH	All U-SU, TU, RH Districts			
	30' or Less	Greater than 30' and up to 40'	Greater than 40' and less than 75'	75' or Greater
Building Coverage per Zone Lot, including all accessory structures (max)	6050%	4537.5%	4537.5%	4037.5%

Example: Urban House in Urban Neighborhood Context

Building Coverage in Curtis Park – 25' lot

Proposed – 60% allowed
without credits

Existing - 50% allowed
plus credits
(with 15' separation)

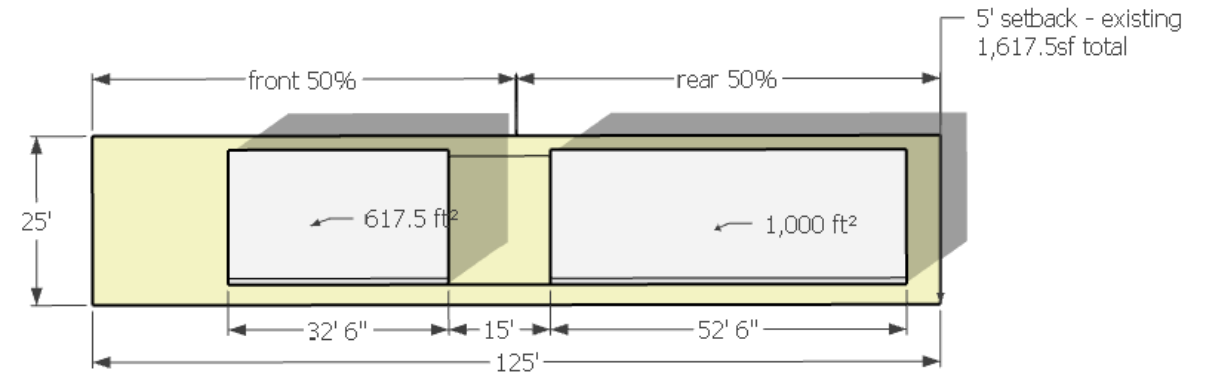
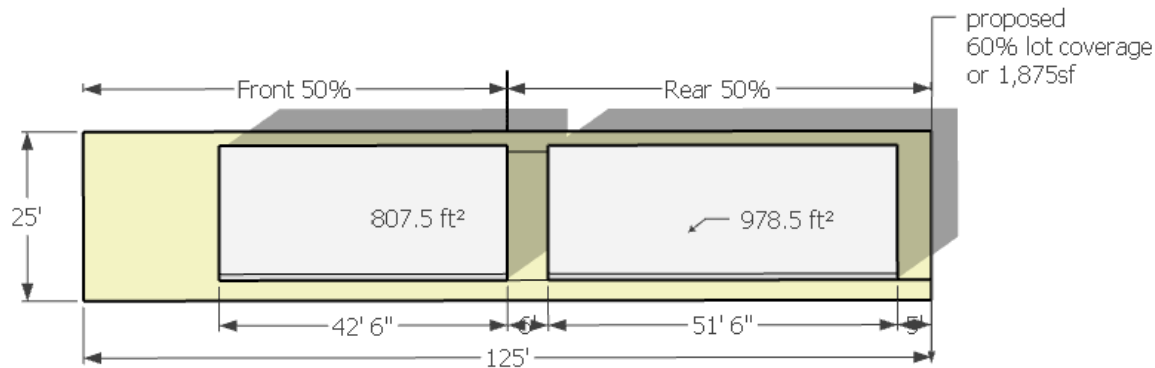

Proposed
Allows 1,786 sf of coverage = or 57 percent
of a 3,125 sf zone lot

Existing
Allows 1,617.5 sf of coverage = or 51.8
percent of a 3,125 sf zone lot

Building Coverage – 30' lot (U-SU-A typical lot size)

Proposed – 60% allowed without credits

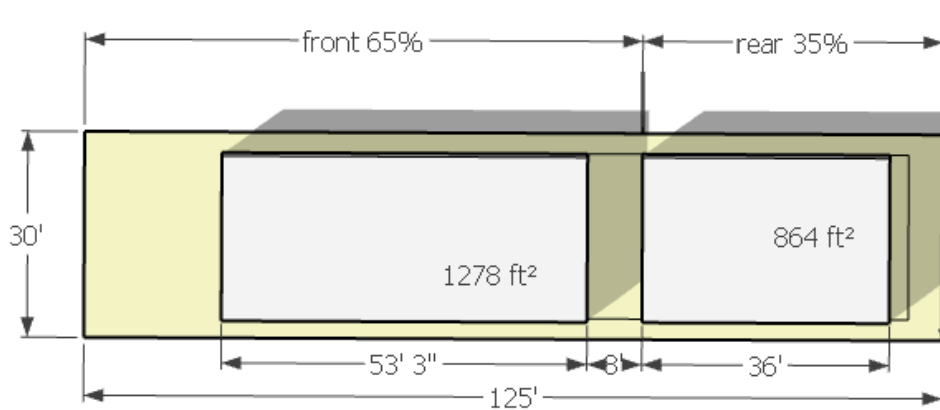

Proposed
Allows 2,142 sf of coverage = or 57 percent of a 3,750 sf zone lot

Existing - 50% allowed plus credits (with 15' separation)

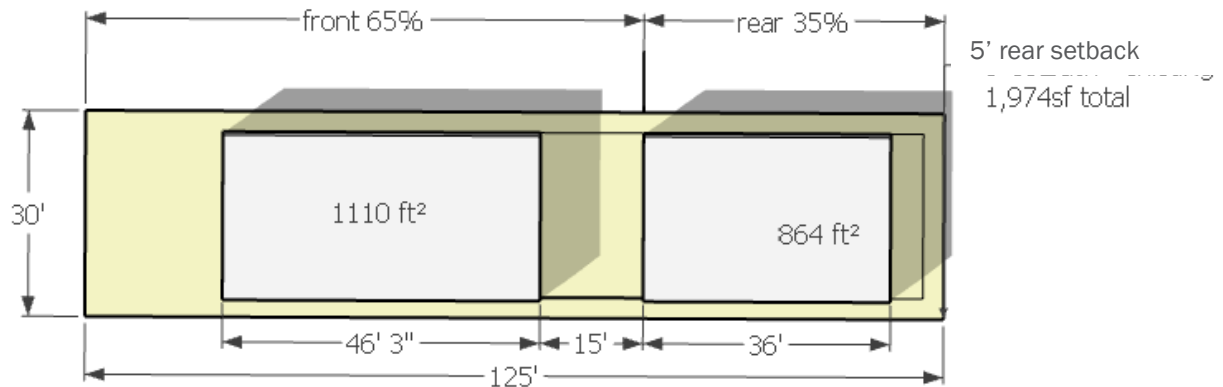

Existing
Allows 1,974 sf of coverage = or 52.6 percent of a 3,750 sf zone lot

»»» Process

- Planning Board Info Item: 6/5/2024
- Public Review Draft Available: 7/9/2024
- Board of Adjustment Discussion: 8/13/2024
- Planning Board Notice: 10/1/2024
- Planning Board Public Hearing: 10/16/2024
- LUTI Info Item: 10/22/2024
- **LUTI Committee: 11/12/2024**
- City Council Public Hearing: 12/16/2024*

* Anticipated dates are confirmed during the legislative review process

Public Comments

- Over 100 comments received on the Public Draft
- Constructive feedback directly provided on standards proposed
- CPD considered all comments and revised some proposed modifications

Revised: Building coverage, mezzanines, parking structure stories, and attached/detached garage standards

Proposed Change: Correct omissions from DADU permissions in Article 3

- Corrects Detached Accessory Dwelling Unit building form use permissions, which were omitted from Article 3 in the Planning Board draft of the Bundle.

Suburban (S-) Neighborhood Context Zone Districts		Max Number of Detached Accessory Structures per Zone Lot	Building Forms	
			Detached Accessory Dwelling Unit	Detached Garage
<u>Maximum number of detached accessory structures per Zone Lot</u>			<u>One per Primary Dwelling Unit*</u>	<u>No</u>
Single Unit (SU)	S-SU-A, -D, -F, -Fx, -I, -Ix	no-max*	■	
	S-SU-A1, -D1, -F1, -F1A, F1x, -I1, -I1x	no-max*	■	
Row House (RH)	S-RH-2.5	no-max*	■	
Multi Unit (MU)	S-MU-3, -5, 8, 12, 20	no-max*	■	
Commercial Corridor (CC)	S-CC-3, -3x, -5, -5x	no-max	■	
Mixed Use (MX)	S-MX-2x	no-max	■	
	S-MX-2, -3, -5, -8, -12	no-max	■	
	S-MX-2A, -3A, -5A, -8A, -12A	no-max	■	
Main Street (MS)	S-MS-3, -5	no-max	■	

ed
lling

■ = Allowed ■ = Allowed subject to limitations

*One per dwelling unit for structures with vehicle access doors, See Section 1.2.3.5.

Proposed Change: Sec. 12.2.7, Cherry Creek Design Advisory Board Appointments

- Removes the requirement that the Cherry Creek Business Improvement District nominate all board members before appointment by the Mayor; retains a requirement that the BID nominate one member.
- Changes are proposed to improve recruitment opportunities for the Board and align this board's appointment process with the 110 other mayoral-appointed boards in the City.

Review Criteria

1. The Text Amendment is Consistent with the City's Adopted Plans

Denver Comprehensive Plan 2040,

- Implementation Strategy 2: “Coordinate implementation actions across departments for effective and collective impact. Improve the integration of regulations—such as design standards for streets and the public realm—across multiple disciplines and departments.”
- Equitable, Affordable and Inclusive, Goal 7: Make neighborhoods accessible to people of all ages and abilities.
- Strong and Authentic Neighborhoods, Goal 1: Create a city of complete neighborhoods.
 - Strategy C: Ensure neighborhoods are safe, accessible and well-connected for all modes.

Review Criteria

1. The Text Amendment is Consistent with the City's Adopted Plans

Denver Comprehensive Plan 2040,

- Strong and Authentic Neighborhoods, Goal 2: Enhance Denver's neighborhoods through high-quality urban design.
 - Strategy C: Create people-oriented places that embrace community character with thoughtful transitions, aspirational design and an engaging public realm.
- Connected, Safe and Accessible Places, Goal 9, Strategy C: "Balance the demand for on- and off-street parking with other community goals including affordability and sustainability."

Review Criteria

1. The Text Amendment is Consistent with the City's Adopted Plans

Blueprint Denver (2019) Policy Guidance

- Land Use and Built Form: General, Policy 3: Ensure the Denver Zoning Code continues to respond to the needs of the city, while remaining modern and flexible. (p. 72)
- Land Use and Built Form: General, Policy 11: Implement plan recommendations through city-led legislative rezonings and text amendments.
- Land Use and Built Form: Economics, Policy 1, Strategy B: Promote the development and redevelopment of regional centers, including downtown, to meet the land use and transportation needs of targeted industries. This means encouraging regional centers to have strong connections to transportation options, especially passenger rail and transit priority streets, and fostering the mix of uses needed to attract businesses with a wide variety of jobs.



Blueprint Denver

Blueprint Denver Contains Three Major Equity Concepts

Integrating these concepts into planning and implementation will help to create a more equitable Denver.



Review Criteria

Text Amendment Furthers the Public Health, Safety and General Welfare

This text amendment furthers the general public health, safety, and welfare of Denver residents, landowners, and businesses by:

- Providing clarity and predictability in the zoning regulations,
- Removing regulatory barriers to planned and desired private enterprise and redevelopment, and
- Continuing to implement the city's adopted comprehensive, land use, and transportation plans through regulatory changes.

Proposed Implementation Schedule

2024 Bundle – Delayed Effective Date and Grace Period	
Targeted Adoption Date	December 16, 2024
Delayed Effective Date	Monday, February 3, 2025
Cut-off for Submittals to Use Previous Code Version	<u>SDPs: Concept plan submittal by August 9, 2024</u> <u>Zoning Permits: Friday, January 31, 2025</u>
Deadline to Get Approval	<u>SDP approval: February 27, 2026 (Friday) (~25 months from effective date)</u> <u>Zoning Permit approval: September 30, 2025 (Monday) (8 months from effective date)</u> <u>Modifications to ZPs allowed until: August 31, 2026 (19 months from effective date)</u>

- Delayed effective date for zoning permits because of significant changes to 1- and 2-unit residential standards
- New: Proposed grace period for SDPs

Questions or Comments?

Contact

Alek Miller, AICP, Senior City Planner
Alek.Miller@denvergov.org

Website:

denvergov.org/zoningbundle