



TO: Land Use, Transportation, and Infrastructure Committee of the Denver City Council
FROM: Scott Robinson, Senior City Planner
DATE: February 1, 2018
RE: Official Zoning Map Amendment Application #2017I-00040

Staff Report and Recommendation

Based on the criteria for review in the Denver Zoning Code, Staff recommends approval for Application #2017I-00040.

Request for Rezoning

Address:	680 Sheridan Boulevard
Neighborhood/Council District:	Villa Park / Council District 3
RNOs:	Inter-Neighborhood Cooperation (INC); Concerned Citizens for Barnum, Inc.; Villa Park Neighborhood Association; Denver Neighborhood Association, Inc.
Area of Property:	7.3 acres
Current Zoning:	PUD 1
Proposed Zoning:	E-MX-3
Property Owner(s):	Storage Equities/PS Partners (d/b/a Public Storage)
Owner Representative:	Galloway & Company, Inc.

Summary of Rezoning Request

- The property is located in the Villa Park neighborhood, at the corner of 6th Ave. and Sheridan Blvd.
- There is currently a mini-storage facility on the property, consisting primarily of single-story buildings accessed by exterior drive aisles.
- The applicant is requesting the rezoning to redevelop the site as a new, multi-story storage facility with interior access.
- The **E-MX-3** (Urban **E**dge, **M**ixed Use, **3** story) zone district is intended to provide safe, active, pedestrian-scaled, diverse areas within and around the city's neighborhoods. Further details of the zone districts can be found in Article 4 of the Denver Zoning Code (DZC).

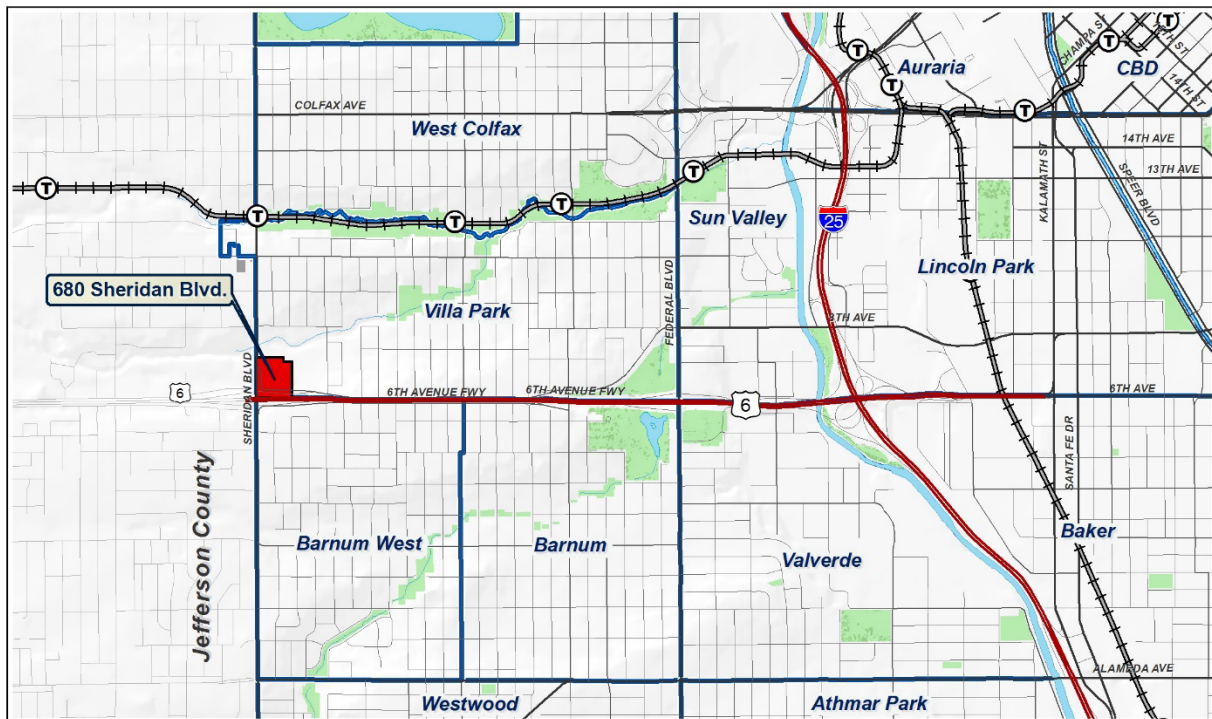
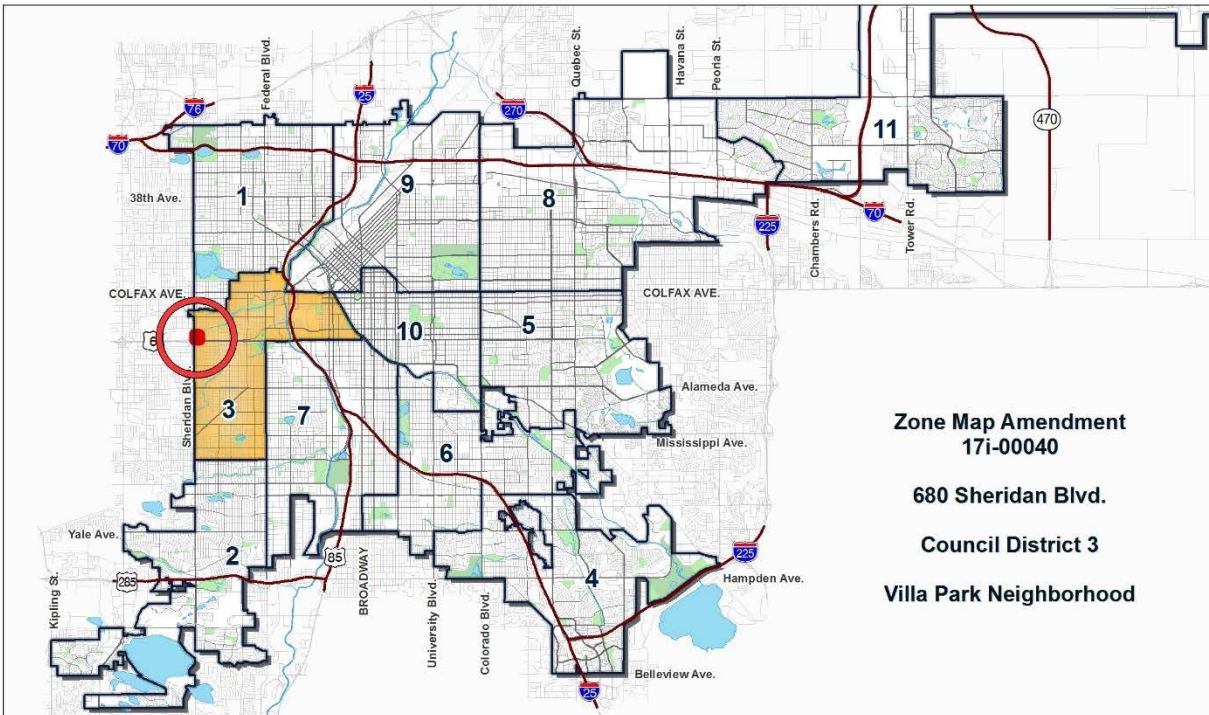

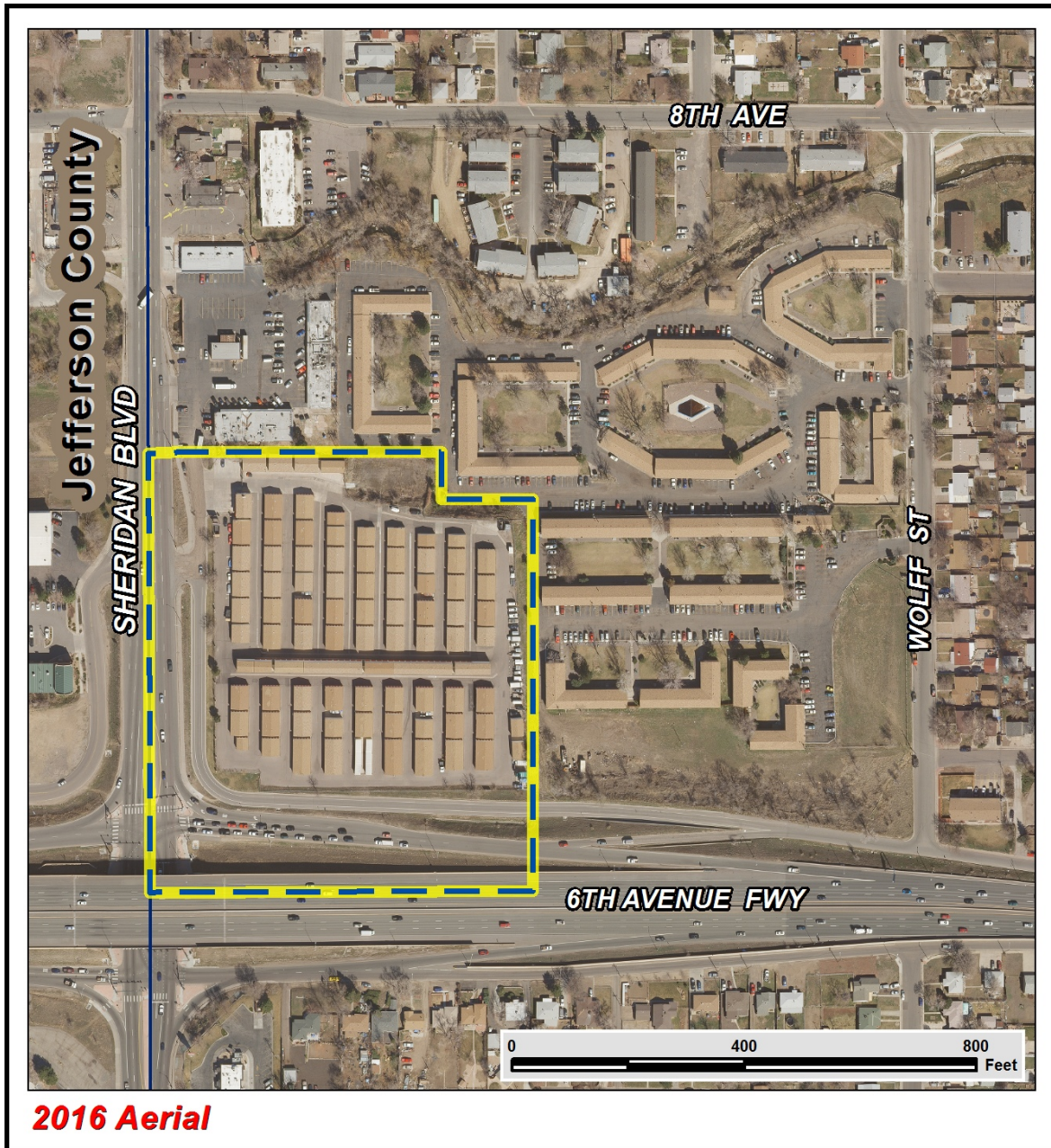

Existing Context

The subject property is on the edge of the city, with Lakewood being to the west across Sheridan Blvd. North and south along Sheridan Blvd. are mixes of auto-oriented commercial uses and residential uses. Immediately to the south is the elevated 6th Ave. Freeway. To the east and northeast of the property are one and two-story apartment buildings, with single-family residential buildings further away. The Lakewood Gulch trail ends about ¼ mile to the northeast, connecting to Martinez Park and

Lakewood/Dry Gulch Park further northeast. There is bus service on Sheridan Blvd. and the Sheridan Station on the W Line Light Rail is about ½ mile to the north.

The following table summarizes the existing context proximate to the subject site:

	Existing Zoning	Existing Land Use	Existing Building Form/Scale	Existing Block, Lot, Street Pattern
Site	PUD 1	Self-storage	1-2 story storage buildings served by drive aisles	The site is part of a large block without internal through-streets that is surrounded by a generally regular street grid. The site is accessed from a frontage road off of Sheridan Blvd. The 6 th Ave. Freeway disrupts the street network to the south. Parking is provided on the front and side of buildings and is accessed from the street.
North	C-MX-5, U-RH-3A	Commercial and residential	1-story strip retail along Sheridan Blvd., 1-2 story apartment buildings further east	
South	B-2 w/ waivers & conditions, E-SU-Dx	Restaurant and residential	1-story drive-through building at Sheridan Blvd., 1-story single-unit residential further east	
East	R-2	Residential	2-story apartment buildings	
West	Lakewood Light Industrial (LI) and Mixed Use General Suburban (M-G-S)	Office and light industrial	1-2 story commercial buildings with large setbacks	

1. Existing Zoning

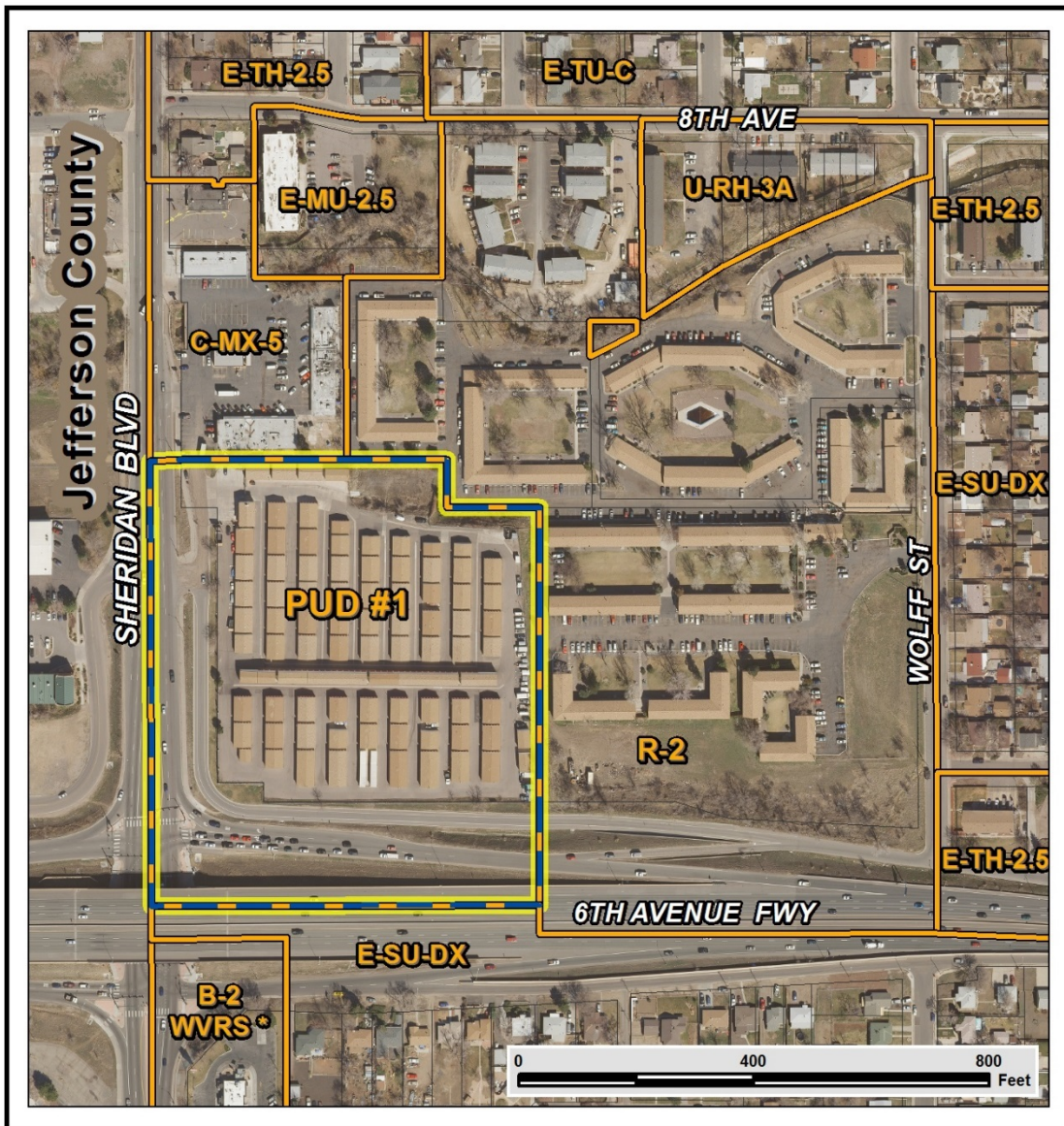

The property is governed by Planned Unit Development (PUD) #1 under the Former Chapter 59 zoning code. A PUD is customized zoning for a specific site. PUD #1 was adopted in 1977 and allows only “mini-warehouse facilities” with a maximum floor area ratio (FAR) of 0.5. The maximum allowed height is one story, except for two two-story buildings. The required setbacks are 20 feet from Sheridan Blvd. and the 6th Ave. Service Road and six feet from the north and east property lines. The PUD also includes specific requirements for landscaping and building design, including roofing material.

2. Existing Land Use Map

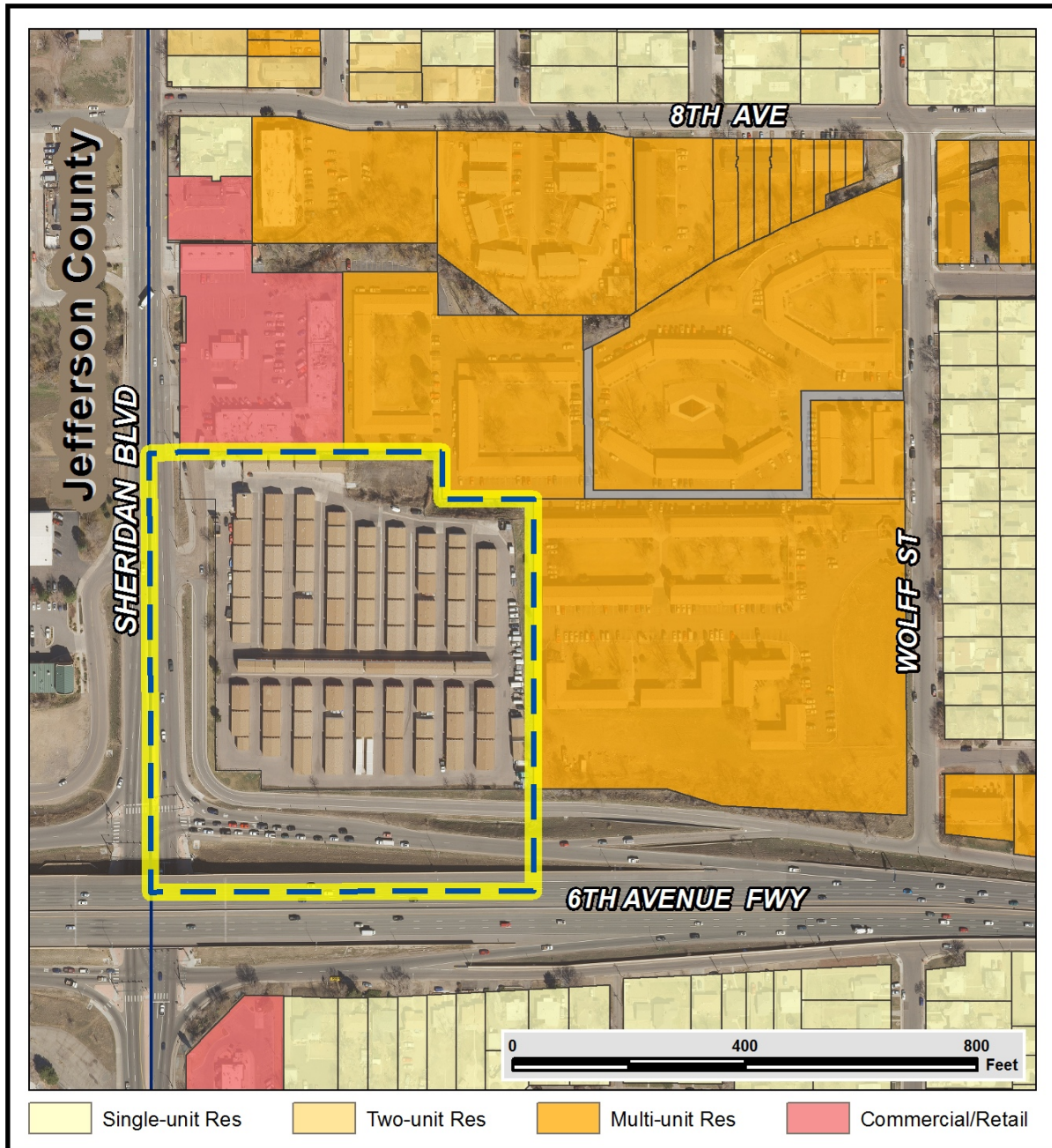

3. Existing Building Form and Scale



Site – from *Sheridan Blvd.*



North – from *Sheridan Blvd.*



East – from *Wolff St.*



South – at *Sheridan Blvd. and 6th Ave.*



West – from *Sheridan Blvd.*
Source: Google Maps

Summary of City Agency Referral Comments

As part of the DZC review process, the rezoning application is referred to potentially affected city agencies and departments for comment. A summary of agency referral responses follows:

Asset Management: Approve – No comments.

Department of Environmental Health: Approve Rezoning Only – Will require additional information at Site Plan Review

- Notes. The Denver Department of Environmental Health (DEH) has information indicating the presence an historical landfill in the area. Redevelopment of the area will require use of a materials management plan to guide handling of solid and possibly hazardous materials. In the 1950's a turkey farm near 8th and Wolff Street was converted to a refuse fill. The fill extends into the area proposed for rezoning. Refuse was used to fill depression in the area ranging from three to 30 feet deep. The fill consisted of municipal, commercial and building debris. Landfilling was terminated in the 1960's. Fourteen exploratory borings were drilled in the vicinity of this landfill (R.J. Pratt 1981) and significant concentrations of methane gas were measured in five of the 14 exploratory borings. A potential gas hazard exist to structures and utility corridors located near or over the landfill. Additionally, the fill likely contains regulated asbestos contaminated soil which will require management during construction.
- General Notes: Most of Colorado is high risk for radon, a naturally occurring radioactive gas. Due to concern for potential radon gas intrusion into buildings, DEH suggests installation of a radon mitigation system in structures planned for human occupation or frequent use. It may be more cost effective to install a radon system during new construction rather than after construction is complete.
- Denver's Noise Ordinance (Chapter 36–Noise Control, Denver Revised Municipal Code) identifies allowable levels of noise. Properties undergoing Re-Zoning may change the acoustic environment, but must maintain compliance with the Noise Ordinance. Compliance with the Noise Ordinance is based on the status of the receptor property (for example, adjacent Residential receptors), and not the status of the noise-generating property. Violations of the Noise Ordinance commonly result from, but are not limited to, the operation or improper placement of HV/AC units, generators, and loading docks. Construction noise is exempted from the Noise Ordinance during the following hours, 7am–9pm (Mon–Fri) and 8am–5pm (Sat & Sun). Variances for nighttime work are allowed, but the variance approval process requires 2 to 3 months. For variance requests or questions related to the Noise Ordinance, please contact Paul Riedesel, Denver Environmental Health (720-865-5410).
- Scope & Limitations: DEH performed a limited search for information known to DEH regarding environmental conditions at the subject site. This review was not intended to conform to ASTM standard practice for Phase I site assessments, nor was it designed to identify all potential environmental conditions. In addition, the review was not intended to assess environmental conditions for any potential right-of-way or easement conveyance process. The City and County of Denver provides no representations or warranties regarding the accuracy, reliability, or completeness of the information provided.

Development Services – Project Coordination: Approve Rezoning Only – Will require additional information at Site Plan Review

- Section 11.5.23 In all MX Zone Districts, a mini storage facility use shall not have individual entrances to storage units from the exterior of the structure. By rezoning to E-MX-3 this site will be in violation of this Code Limitation unless specifically permitted with conditions, or if the mini-storage units are removed prior to approval of the rezoning.
- The current mini-storage site does not meet Build-To, Transparency, Pedestrian Entrance, and the off-street parking landscaping requirements under the proposed E-MX-3 Zone District.
- Sheridan Blvd is a designated Commercial Corridor which will require additional streetscape landscaping once a SDP is submitted.

Public Works – City Surveyor: Approve – No comments.

Public Review Process

	Date
CPD informational notice of receipt of the rezoning application to all affected members of City Council and registered neighborhood organizations:	8/28/17
Property legally posted for a period of 15 days and CPD written notice of the Planning Board public hearing sent to all affected members of City Council and registered neighborhood organizations:	12/29/17
Planning Board recommended approval of the application by a vote of 9-0:	1/17/18
CPD written notice of the Land Use, Transportation and Infrastructure Committee meeting sent to all affected members of City Council and registered neighborhood organizations, at least ten working days before the meeting:	1/26/18
Land Use, Transportation and Infrastructure Committee of the City Council review:	2/6/18
Property legally posted for a period of 21 days and CPD written notice of the City Council public hearing sent to all affected members of City Council and registered neighborhood organizations (tentative):	2/23/18
City Council Public Hearing (tentative):	3/19/18

- **Registered Neighborhood Organizations (RNOs)**
 - To date, no comments from RNOs have been received.
- **Other Public Comment**
 - To date, no other comments have been received.

Criteria for Review / Staff Evaluation

The criteria for review of this rezoning application are found in DZC, Sections 12.4.10.7 and 12.4.10.8, as follows:

DZC Section 12.4.10.7

1. Consistency with Adopted Plans
2. Uniformity of District Regulations and Restrictions
3. Public Health, Safety and General Welfare

DZC Section 12.4.10.8

1. Justifying Circumstances
2. Consistency with Neighborhood Context Description, Zone District Purpose and Intent Statements

1. Consistency with Adopted Plans

The following adopted plans apply to this property:

- Denver Comprehensive Plan 2000
- Blueprint Denver (2002)
- Villa Park Neighborhood Plan (1991)

Denver Comprehensive Plan 2000

The proposal is consistent with many Denver Comprehensive Plan strategies, including:

- Environmental Sustainability Strategy 2-F – *Conserve land by promoting infill development within Denver at sites where services and infrastructure are already in place; designing mixed use communities and reducing sprawl so that residents can live, work and play within their own neighborhoods.*
- Land Use Strategy 3-B – *Encourage quality infill development that is consistent with the character of the surrounding neighborhood; that offers opportunities for increased density and more amenities; and that broadens the variety of compatible uses.*
- Mobility Strategy 4-E – *Continue to promote mixed-use development, which enables people to live near work, retail and services.*
- Economic Activity Strategy 4-B – *Enhance existing business centers and establish new business centers in a manner that offers a variety of high-quality uses that support Denver’s business environment, complements neighboring residential areas, generates public revenue, and creates jobs. Consider the following key strategies at top priorities:... Continue to strengthen and, where necessary, revitalize Denver’s commercial corridors....*

The proposed map amendment will enable mixed-use development at an infill location where services and infrastructure are already in place. The E-MX zone districts broaden the variety of allowed uses, which would allow new development to help revitalize the Sheridan Blvd. corridor. The rezoning is consistent with these plan recommendations.

Blueprint Denver

According to the 2002 Plan Map adopted in Blueprint Denver, this site has a concept land use of Single Family Duplex and is located in an Area of Stability.

Future Land Use

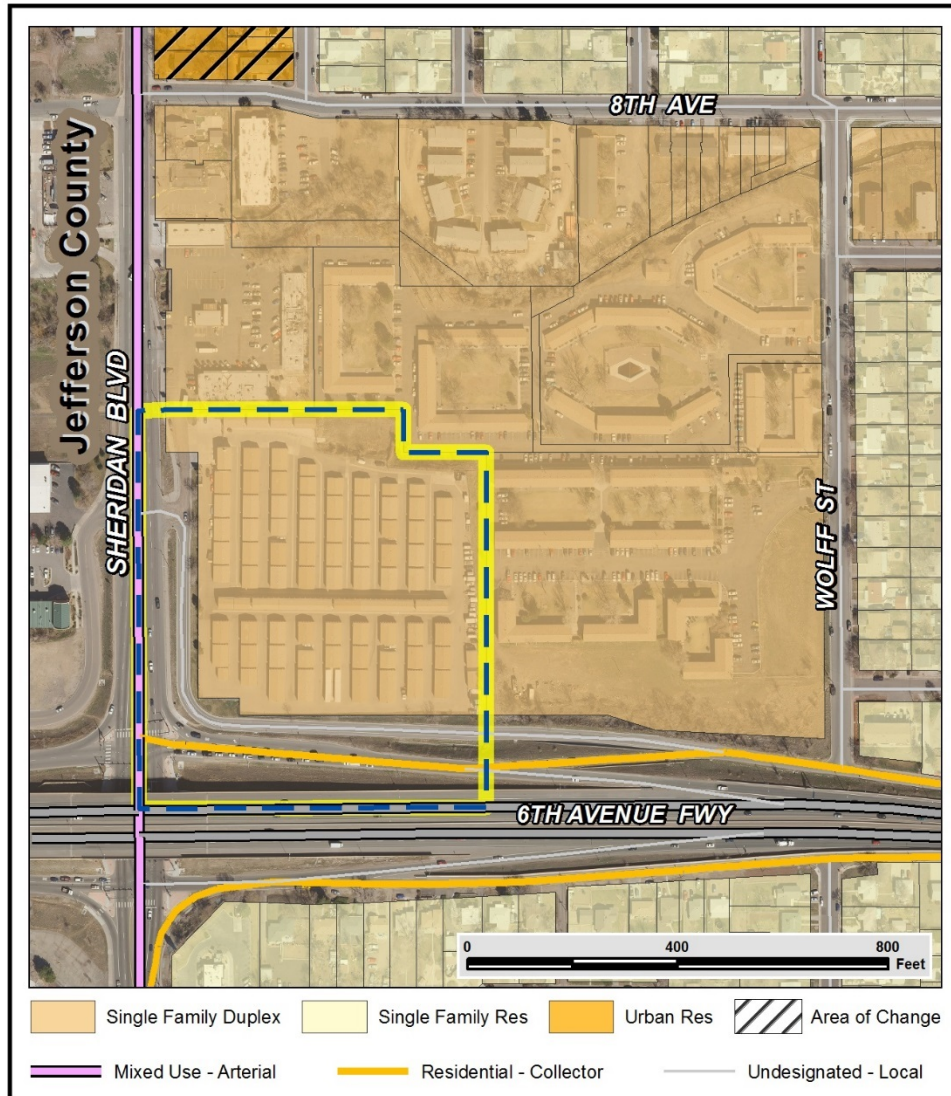

The plan defines Single Family Duplex as “moderately dense areas that are primarily residential but with some complementary, small-scale commercial uses. However, the employment base is minor compared to the housing base” (p. 42). The subject site is an existing commercial development predominantly surrounded by residential uses. The proposed E-MX-3 zoning would allow a range of commercial and residential uses that would complement the surrounding development. While the site is larger than what is typically considered for “small-scale commercial uses,” the Villa Park neighborhood does not have small commercial nodes scattered throughout like many other Denver

neighborhoods do, so larger concentrations of mixed use development at the edges would help achieve the desired development mix across the neighborhood.

Area of Change / Area of Stability

Blueprint Denver designates the subject property as in an Area of Stability. According to the plan, “the goal for Areas of Stability is to identify and maintain the character of an area while accommodating some new development and redevelopment” (p. 120). The existing zoning limits the ability to redevelop the property, allowing only what currently exists. The proposed E-MX-3 zoning would allow redevelopment of a use mix, intensity, and scale that is consistent with the character of the neighborhood.

Street Classifications

Blueprint Denver classifies Sheridan Blvd. as a Mixed-Use Arterial and classifies the 6th Ave. Service Road as an Undesignated Local. Mixed-Use streets are intended for “high-intensity mixed-use commercial, retail, and residential areas with substantial pedestrian activity” (p. 57). Local streets are for travel that is “typically incidental and involves relatively short trips at lower speeds to and from other streets” (p. 51). The proposed E-MX-3 zoning would allow for mixed-use development consistent with the intent of the Mixed-Use Arterial designation of Sheridan Blvd., while the 6th Ave. Service Road would provide local access as intended. When the street classification is considered with the Single Family Duplex and Area of Stability designations, as a whole the proposed rezoning is consistent with Blueprint Denver.

Planned Unit Developments

Blueprint Denver provides the following policy guidance regarding PUD zoning (p. 82): “Concerns with PUDs are that their widespread proliferation has increased the complexity of regulating land use, and the conditions they place on development sometimes perform poorly and inflexibly once the PUD has been adopted. This issue can be addressed if the city acts on the authority to repeal obsolete PUD zoning and change it to a more appropriate district.” The standards of the existing PUD on this site are inflexible and obsolete. Blueprint Denver recommends rezoning the city from the old Former Chapter 59 zoning code to the new Denver Zoning Code. Rezoning to a standard zone district in the Denver Zoning Code will implement the cited Blueprint Denver plan guidance.

Villa Park Neighborhood Plan

The Villa Park Neighborhood Plan was adopted by City Council in 1991 and includes goals and strategies for the neighborhood. Goal UD-1 of the plan is to “Improve Neighborhood Arterials” and the appearance of businesses along them (p. 11). The proposed rezoning to E-MX-3 would allow for the redevelopment of the subject property under the Denver Zoning Code, which has stronger design requirements, especially for areas adjacent to the street, than the existing PUD.

Strategy LZ-1 of the plan is to “Discourage higher density development” (p. 18), though this section of the plan focuses on residential areas of the neighborhood and does not mention commercial areas. Strategy LZ-2 is to “Discourage development that is incompatible with the scale and quality of the neighborhood” (p. 19), but does not give any more description of what is compatible or incompatible. The proposed rezoning would allow commercial or residential development up to three stories, which is

taller than the one and two-story buildings immediately surrounding the subject site. However, there are several three-story or taller buildings elsewhere in the neighborhood and the site's location at the edge of the neighborhood would allow for a transition from the major roadways of Sheridan Blvd. and 6th Ave. to the one and two-story structures that primarily make up the interior of the neighborhood.

Goal B-4 of the plan is to "Support and enhance neighborhood commercial activities" (p. 24) and Strategy B-4c is to "Increase retail activity" (p. 25). The proposed rezoning would facilitate the redevelopment of a commercial development built in 1978, allowing for reinvestment in the business or the introduction of new businesses. Overall, the proposed rezoning to E-MX-3 would allow commercial and residential development at a compatible scale consistent with the Villa Park Neighborhood Plan.

2. Uniformity of District Regulations and Restrictions

The proposed rezoning to E-MX-3 would result in the uniform application of zone district building form, use and design regulations.

3. Public Health, Safety and General Welfare

The proposed official map amendment furthers the public health, safety, and general welfare of the City primarily through implementation of the city's adopted land use plan. It would also facilitate redevelopment of an older commercial site with the improved building form, design, and development standards of the Denver Zoning Code.

4. Justifying Circumstance

The application identifies several changed or changing conditions as the Justifying Circumstance under DZC Section 12.4.10.8.A.4, "The land or its surrounding environs has changed or is changing to such a degree that it is in the public interest to encourage a redevelopment of the area or to recognize the changed character of the area." The existing zoning is a PUD that was adopted in 1977 and is restrictive in both use and design, making redevelopment under the current zoning difficult. Additional development has occurred in the area, increasing demand for commercial uses. In addition, the quality of the site has deteriorated and the area would benefit from reinvestment. There has also been public investment in the nearby transportation network, including 6th Avenue, Sheridan Boulevard, and the W line. Thus, the map amendment is justified by changes on the site and in the surrounding area that make redevelopment in the public interest.

5. Consistency with Neighborhood Context Description, Zone District Purpose and Intent Statements

The requested E-MX-3 zone district is within the Urban Edge Neighborhood Context. The neighborhood context generally consists of single-unit and two-unit residential uses and small-scale commercial areas that are typically embedded in residential areas (DZC, Division 4.1). Because the current zoning is PUD it does not have a defined context, but most of the Villa Park neighborhood is within the Urban Edge context. The proposed rezoning to E-MX-3 would allow small-scale commercial or residential development consistent with the neighborhood context description.

According to the zone district intent stated in the Denver Zoning Code, the E-MX-3 district “applies to areas or intersections served primarily by collector or arterial streets where a building scale of 1 to 3 stories is desired” (DZC Section 4.2.4.2.D). The property is served by an arterial street and is just north of a major freeway. In addition, the DZC states “Mixed Use districts are appropriate along corridors, embedded in neighborhoods, and on large sites.” (DZC Section 4.2.4.1.C). The subject site is along a corridor and is relatively large. The street classifications and desired building heights in this area and the location of the site are consistent with the zone district purpose and intent statements.

Attachments

1. Application
2. PUD #1



Zone Map Amendment (Rezoning) - Application

PROPERTY OWNER INFORMATION*		PROPERTY OWNER(S) REPRESENTATIVE**	
<input type="checkbox"/> CHECK IF POINT OF CONTACT FOR APPLICATION		<input checked="" type="checkbox"/> CHECK IF POINT OF CONTACT FOR APPLICATION	
Property Owner Name	Public Storage, a Maryland Real Estate Investment Trust	Representative Name	Galloway & Company, Inc.
Address	PO BOX 25025	Address	6162 S. Willow Drive, Suite 320
City, State, Zip	Glendale, CA 91221-5025	City, State, Zip	Greenwood Village, CO 80111
Telephone	972-591-2669	Telephone	303-770-8884
Email		Email	ZellCantrell@GallowayUS.com
<p>*If More Than One Property Owner: All standard zone map amendment applications shall be initiated by all the owners of at least 51% of the total area of the zone lots subject to the rezoning application, or their representatives authorized in writing to do so. See page 3.</p>		<p>**Property owner shall provide a written letter authorizing the representative to act on his/her behalf. Letter of Authorization Included</p>	
<p>Please attach Proof of Ownership acceptable to the Manager for each property owner signing the application, such as (a) Assessor's Record, (b) Warranty deed or deed of trust, or (c) Title policy or commitment dated no earlier than 60 days prior to application date.</p> <p>If the owner is a corporate entity, proof of authorization for an individual to sign on behalf of the organization is required. This can include board resolutions authorizing the signer, bylaws, a Statement of Authority, or other legal documents as approved by the City Attorney's Office.</p>			
SUBJECT PROPERTY INFORMATION			
Location (address and/or boundary description):	680 Sheridan Boulevard (NEC of 6th and Sheridan) Denver, CO 80214-3001		
Assessor's Parcel Numbers:	0506600128000		
Area in Acres or Square Feet:	7.30 Acres		
Current Zone District(s):	PUD 1		
PROPOSAL			
Proposed Zone District:	E-MX-3		

REVIEW CRITERIA	
<p>General Review Criteria: The proposal must comply with all of the general review criteria DZC Sec. 12.4.10.7</p>	<p><input checked="" type="checkbox"/> Consistency with Adopted Plans: The proposed official map amendment is consistent with the City's adopted plans, or the proposed rezoning is necessary to provide land for a community need that was not anticipated at the time of adoption of the City's Plan.</p> <p>Please provide an attachment describing relevant adopted plans and how proposed map amendment is consistent with those plan recommendations; or, describe how the map amendment is necessary to provide for an unanticipated community need.</p> <p><input checked="" type="checkbox"/> Uniformity of District Regulations and Restrictions: The proposed official map amendment results in regulations and restrictions that are uniform for each kind of building throughout each district having the same classification and bearing the same symbol or designation on the official map, but the regulations in one district may differ from those in other districts.</p> <p><input checked="" type="checkbox"/> Public Health, Safety and General Welfare: The proposed official map amendment furthers the public health, safety, and general welfare of the City.</p>
<p>Additional Review Criteria for Non-Legislative Rezoning: The proposal must comply with both of the additional review criteria DZC Sec. 12.4.10.8</p>	<p>Justifying Circumstances - One of the following circumstances exists:</p> <p><input type="checkbox"/> The existing zoning of the land was the result of an error.</p> <p><input type="checkbox"/> The existing zoning of the land was based on a mistake of fact.</p> <p><input type="checkbox"/> The existing zoning of the land failed to take into account the constraints on development created by the natural characteristics of the land, including, but not limited to, steep slopes, floodplain, unstable soils, and inadequate drainage.</p> <p><input type="checkbox"/> The land or its surroundings has changed or is changing to such a degree that it is in the public interest to encourage a redevelopment of the area to recognize the changed character of the area.</p> <p><input checked="" type="checkbox"/> It is in the public interest to encourage a departure from the existing zoning through application of supplemental zoning regulations that are consistent with the intent and purpose of, and meet the specific criteria stated in, Article 9, Division 9.4 (Overlay Zone Districts), of this Code.</p> <p>Please provide an attachment describing the justifying circumstance.</p> <p><input checked="" type="checkbox"/> The proposed official map amendment is consistent with the description of the applicable neighborhood context, and with the stated purpose and intent of the proposed Zone District.</p> <p>Please provide an attachment describing how the above criterion is met.</p>
REQUIRED ATTACHMENTS	
Please ensure the following required attachments are submitted with this application:	
<input checked="" type="checkbox"/> Legal Description (required to be attached in Microsoft Word document format) <input checked="" type="checkbox"/> Proof of Ownership Document(s) <input checked="" type="checkbox"/> Review Criteria	
ADDITIONAL ATTACHMENTS	
Please identify any additional attachments provided with this application:	
<input checked="" type="checkbox"/> Written Authorization to Represent Property Owner(s) <input type="checkbox"/> Individual Authorization to Sign on Behalf of a Corporate Entity	
Please list any additional attachments:	
Letter of Authorization Included	

PROPERTY OWNER OR PROPERTY OWNER(S) REPRESENTATIVE CERTIFICATION/PETITION

We, the undersigned represent that we are the owners of the property described opposite our names, or have the authorization to sign on behalf of the owner as evidenced by a Power of Attorney or other authorization attached, and that we do hereby request initiation of this application. I hereby certify that, to the best of my knowledge and belief, all information supplied with this application is true and accurate. I understand that without such owner consent, the requested official map amendment action cannot lawfully be accomplished.

Property Owner Name(s) (please type or print legibly)	Property Address City, State, Zip Phone Email	Property Owner Interest % of the Area of the Zone Lots to Be Rezoned	Please sign below as an indication of your consent to the above certification statement	Date	Indicate the type of ownership documentation provided: (A) Assessor's record, (B) warranty deed or deed of trust, (C) title policy or commitment, or (D) other as approved	Has the owner authorized a representative in writing? (YES/NO)
EXAMPLE John Alan Smith and Josie Q. Smith	123 Sesame Street Denver, CO 80202 (303) 555-5555 sample@sample.gov	100%	<i>John Alan Smith</i> <i>Josie Q. Smith</i>	01/01/12	(A)	YES
Public Storage, a Maryland Real Estate Investment Trust	PO Box 25025 Glendale, CA 91221- 5025	100%	<i>[Signature]</i>	8/25/17	Certificate of Secretary	YES

City and County Of Denver
Community Planning & Development
201 W. Colfax Ave., Dept. 205
Denver, CO 80202

August 17, 2017

RE: Rezoning Application – Letter of Authorization (680 Sheridan Blvd., Denver, Colorado)

To Whom It May Concern:

PUBLIC STORAGE, A MARYLAND REAL ESTATE INVESTMENT TRUST (“OWNER”) as owner of the above-referenced Property hereby designates Galloway & Company, Inc., authorized representative of Owner to submit an application for rezoning and other necessary applications as they pursue necessary approvals for the proposed development of Public Storage at the referenced Property.

Galloway is not authorized to execute any binding documents on behalf of OWNER.

This letter confirms that the undersigned represents the sole ownership of the Property and that no other party’s consent is required to represent said ownership for required development and permitting applications.

Sign: 
Title: SVP Capital Investments

Date: 8/23/2017

Subscribed and affirmed before me in the county of Collin, State of ~~Colorado~~ Texas,
this 23rd day of August, 2017

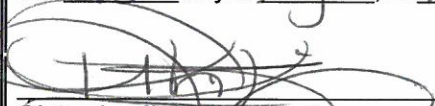
(Notary's official signature)

August 24, 2019
(Commission Expiration)



HYLEJHNEA K. MILES
Notary Public, State of Texas
My Commission Expires
August 24, 2019

**PUBLIC STORAGE
CERTIFICATE OF SECRETARY**

The undersigned, Lily Yan Hughes, hereby certifies that she is the duly elected, qualified and acting Corporate Secretary of Public Storage, a Maryland real estate investment trust (the "Company"), with access to the books and records of the Company, and its affiliates, and that:

1. Storage Equities/PS Partners VII – Sheridan, a California general partnership ("Sheridan"), is the owner of record of that certain property located at 680 Sheridan Boulevard, Denver, Colorado 80214 (the "Property").
2. On December 31, 1990, Sheridan contributed the Property to SEI/PSP VII Joint Ventures, a California general partnership ("SEIPSP7").
3. Subsequently, the general partners of SEIPSP7, affiliated companies controlled by Public Storage, Inc., a California corporation ("PSI"), transferred the Property to PSI.
4. On June 1, 2007, PSI merged with and into the Company, with the Company being the surviving entity.
5. As a result of the above-referenced contribution, transfer and merger, the Company is the legal owner of the Property.
6. Tim Stanley, Senior Vice President – Capital Investments, Sharon Linder, Vice President, Jarrod Yates, Vice President of Development, and Bryan Miranda, Vice President of Development are each authorized to execute and deliver each of the Rezoning Application – Letter of Authorizatin, and Zone Map Amendment (Rezoning) - Application as they each relate to the rezoning project at the Property, on behalf of the Company. This certificate remains in effect until the rezoning project is complete.

IN WITNESS WHEREOF, the undersigned has signed this certificate on this 23rd day of August 2017.



Lily Yan Hughes
Corporate Secretary

LEGAL DESCRIPTION
(Per Title Commitment & ALTA/NSPS Land Title Survey)

THAT PART OF THE SOUTHWEST 1/4 OF THE SOUTHWEST 1/4 OF SOUTHWEST 1/4 OF SECTION 6, TOWNSHIP 4 SOUTH, RANGE 68 WEST OF THE 6TH P.M., AND MORE PARTICULARLY DESCRIBED AS FOLLOWS:

BEGINNING AT A POINT 195 FEET NORTH AND 110 FEET EAST OF THE SOUTHWEST CORNER OF SAID SECTION 6; THENCE NORTH 0 DEGREES 02 MINUTES EAST, AND PARALLEL TO THE WEST LINE OF SAID SOUTHWEST 1/4, 466.6 FEET; THENCE NORTH 89 DEGREES 12 MINUTES 30 SECONDS WEST, 60 FEET, THENCE NORTH 0 DEGREES 02 MINUTES EAST, AND PARALLEL TO THE WEST LINE OF SAID SOUTHWEST 1/4 88.8 FEET; THENCE SOUTH 89 DEGREES 12 MINUTES 30 SECONDS EAST, 445 FEET, THENCE SOUTH 0 DEGREES 02 MINUTES WEST, 88.8 FEET HENCE SOUTH 89 DEGREES 12 MINUTES 30 SECONDS EAST, 157.46 FEET.;THENCE SOUTH 0 DEGREES 07 MINUTES 30 SECONDS EAST, 493 FEET; THENCE NORTH 89 DEGREES 58 MINUTES WEST, 463.78 FEET; THENCE NORTH 0 DEGREES 02 MINUTES EAST, 32.5 FEET; THENCE NORTH 89 DEGREES 12 MINUTES WEST, 80 FEET MORE OR LESS TO THE POINT OF BEGINNING. CITY AND COUNTY OF DENVER, STATE OF COLORADO.

TOGETHER WITH THE RIGHTS CREATED IN THAT CERTAIN EASEMENT DATED JULY 24, 1978, AND RECORDED AUGUST 11, 1978, IN BOOK 1724 AT PAGE 448, DENVER COUNTY RECORDS, COLORADO.

WARRANTY DEED

THIS DEED, Made this 18th day of December

19 86, between Storage Equities, Inc., a California corporation, and PS Partners VII, Ltd., a California Limited Partnership, as tenants-in-common

of the California *County of Los Angeles
State of ~~Colorado~~, grantor, and

Storage Equities/PS Partners VII - Sheridan,
a California general partnership ~~-a corporation organized and~~
~~existing under and by virtue of the laws of the State of~~

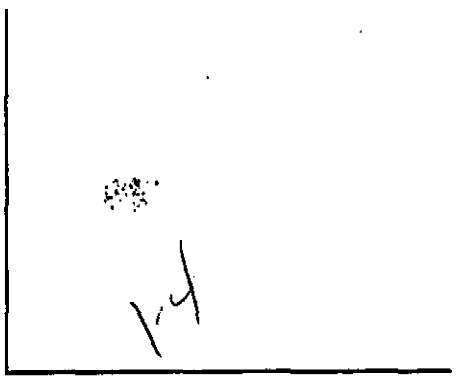

, grantee: whose legal address is
c/o Public Storage, Inc.
1015 Grandview Avenue, Glendale, California 91201

WITNESSETH, That the grantor, for and in consideration of the sum of ten and no/100 (\$10.00) DOLLARS,

the receipt and sufficiency of which is hereby acknowledged, has granted, bargained, sold and conveyed, and by these presents does grant, bargain, sell, convey and confirm, unto the grantee, its successors and assigns forever, all of the real property, together with improvements, if any, situate, lying and being in the City of Denver County of Denver and State of Colorado, described as follows:

See Exhibit A attached hereto and made a part hereof.

NO 12.00

This deed is being recorded for title purposes only.
No documentary fee.

No doc Fee

also known by street and number as: 680 Sheridan Boulevard

TOGETHER with all and singular the hereditaments and appurtenances thereunto belonging or in anywise appertaining, and the reversion and reversions, remainder and remainders, rents, issues and profits thereof, and all the estate, right, title, interest, claim and demand whatsoever of the grantor, either in law or equity, of, in and to the above bargained premises, with the hereditaments and appurtenances.

TO HAVE AND TO HOLD the said premises above bargained and described, with the appurtenances, unto the grantee, its successors and assigns forever. And the grantor, for himself, his heirs and personal representatives, does covenant, grant, bargain and agree to and with the grantee, its successors and assigns, that at the time of the ensembling and delivery of these presents, he is well seized of the premises above conveyed, has good, sure, perfect, absolute and indefeasible estate of inheritance, in law, in fee simple, and has good right, full power and lawful authority to grant, bargain, sell and convey the same in manner and form as aforesaid, and that the same are free and clear from all former and other grants, bargains, sales, liens, taxes, assessments, encumbrances and restrictions of whatever kind or nature soever, except 1) Taxes for the current year not yet due and 2) Conditions, restrictions, rights, rights of way, and easements of record.

The grantor shall and will WARRANT AND FOREVER DEFEND the above-bargained premises in the quiet and peaceable possession of the grantee, its successors and assigns, against all and every person or persons lawfully claiming the whole or any part thereof.

The singular number shall include the plural, the plural the singular, and the use of any gender shall be applicable to all genders.

IN WITNESS WHEREOF, The grantor has executed this deed on the date set forth above.

[See attached signature page and
acknowledgements]

STATE OF COLORADO
County of _____

ss.

The foregoing instrument was acknowledged before me this _____ day of _____, 19 _____

by _____
My commission expires _____

WITNESS my hand and official seal.

Notary Public

*If in Denver, insert "City and."

AF 217721

No. _____

WARRANTY DEED

Storage Equities, Inc. and
PS Partners VII, Ltd., a
California Limited Partnership

TO

Storage Equities /
PS Partners VII - Sheridan

STATE OF COLORADO,

County of _____ } ss.

I hereby certify that this instrument was filed for record in my
office this _____ day of _____, 19____

at _____ o'clock _____ M., and duly recorded

in Book _____, Page _____

Run No. _____ Reception No. _____

Recorder

By _____ Deputy

Fees, \$ _____

BRADFORD PUBLISHING CO.



DIRECT ALL INQUIRIES TO:
Old Republic National Commercial Title Services
521 Fifth Avenue
23rd Floor
New York, NY 10175
Phone: 212-599-1300 Fax: 212-983-2791

File No.: **CO249370**
Typist Initials: **DRios**

This commitment is prepared for informational purposes only and does not contemplate the issuance of a title insurance policy. The liability assumed by the Company hereunder shall be limited to the lesser of the sums paid therefor or one thousand (\$1,000.00) dollars for any reason whatsoever, whether based on contract or negligence, and shall be confined to the applicant to whom the certificate is addressed.

If title insurance is desired, the Company must be provided with the full details of the proposed transaction and this certificate will be amended accordingly.

1. Effective Date: April 5, 2018 at 5:00 P.M.
2. Title to the Fee Simple estate or interest in the land is at the Effective Date vested in:

Storage Equities/PS Partners VII - Sheridan, a California general partnership

Source of Title: Warranty Deed made by Storage Equities, Inc. and PS Partners VII, Ltd. dated December 18, 1986 recorded December 23, 1986 at Reception No. 00067272.

3. The land referred to in this Commitment is situated in the County of Denver, State of CO, and described as follows:

See Exhibit A Attached Legal Description

Search made of the Fulton County Records from August 1, 1986 through April 5, 2017 discloses the following of record:

1. Right of Way Easement granted to Harry F. Bair in Instrument recorded June 12, 1941 in Book 5517 Page 427.
2. The effects of the Sheridan Mini Storage P.D.B. recorded April 7, 1978 as Reception No. 037641.
3. Sewer Easement recorded August 11, 1978 in Book 1724 Page 448 (affects easement parcel).
4. Terms, conditions and provisions of Easement Grant in Private Roads recorded November 2, 1959 in Book 8430 Page 417 and May 24, 1962 in Book 8851 Page 63 (affects easement parcel).

TAX SEARCH

The tax search made herein covers only the premises
as described, and no search is made against any
part of the street on which said premises abut.

Some items returned hereon may have been paid but payment not officially posted. Receipted bills should be produced on closing. Policy does not insure against items not a lien up to the date of the policy, nor for installments for assessments due after date of this policy. Policy does not insure against pending assessments.

If premises are benefited by a Real Estate Tax Abatement personal to an exempt owner, additional taxes may accrue or may have accrued due to a change in ownership or possession. Any restored taxes from the date of transfer of title or possession from the exempt owner, must be fixed and paid prior to closing of title.

Policy will except water and sewer rent not entered and/or water and sewer rent entered subsequent to date of last reading.

NOTE: If meter entries herein indicated average or minimum readings, an actual should be obtained prior to closing of title or policy will except any possible charge that an actual reading may disclose.

Premises: 680 Sheridan Boulevard, Denver, Colorado
PIN: 0506600128000

First Installment	\$105,787.67	Due February 28, 2017	Paid
Second Installment	\$105,787.65	Due June 15, 2017	Open

EXHIBIT A

That part of the Southwest ¼ of the Southwest ¼ of Section 6, Township 4 South, Range 68 West, of the Sixth P.M. and more particularly described as follows:

BEGINNING at a point 195 feet north and 110 feet east of the Southwest corner of said Section 6;

THENCE North 0 degrees 02 minutes 00 seconds East, and parallel to the west line of said Southwest ¼, 466.6 feet;

THENCE North 89 degrees 12 minutes 30 seconds West, 60 feet;

THENCE North 0 degrees 02 minutes East and parallel to the west line of said Southwest ¼, 88.8 feet;

THENCE South 89 degrees 12 minutes 30 seconds East, 445 feet;

THENCE South 0 degrees 07 minutes 30 seconds East, 493 feet;

THENCE North 89 degrees 58 minutes West, 463.78 feet;

THENCE North 0 degrees 02 minutes East, 32.5 feet;

THENCE North 89 degrees 12 minutes West, 80 feet more or less to the POINT OF BEGINNING, City and County of Denver, State of Colorado.

TOGETHER with the rights created in that certain easement dated July 24, 1978 recorded August 11, 1978 in Book 1724 Page 448, Denver County Records, Colorado.

WARRANTY DEED

THIS DEED, Made this 18th day of December

19 86, between Storage Equities, Inc., a California corporation, and PS Partners VII, Ltd., a California Limited Partnership, as tenants-in-common

of the California *County of Los Angeles
State of ~~Colorado~~, grantor, and

Storage Equities/PS Partners VII - Sheridan,
a California general partnership ~~-a corporation organized and-~~
~~existing under and by virtue of the laws of the State of~~

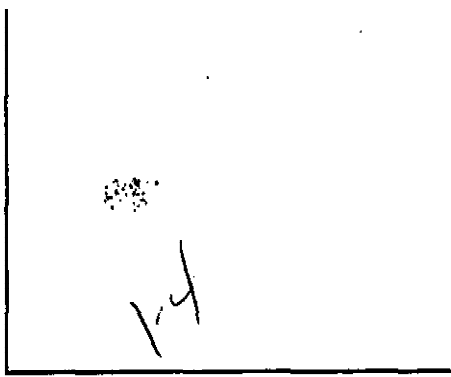

, grantee: whose legal address is
c/o Public Storage, Inc.
1015 Grandview Avenue, Glendale, California 91201

WITNESSETH, That the grantor, for and in consideration of the sum of ten and no/100 (\$10.00) DOLLARS.

the receipt and sufficiency of which is hereby acknowledged, has granted, bargained, sold and conveyed, and by these presents does grant, bargain, sell, convey and confirm, unto the grantee, its successors and assigns forever, all of the real property, together with improvements, if any, situate, lying and being in the City of Denver County of Denver and State of Colorado, described as follows:

See Exhibit A attached hereto and made a part hereof.

NO 12.00

This deed is being recorded for title purposes only.
No documentary fee.

No doc Fee

also known by street and number as: 680 Sheridan Boulevard

TOGETHER with all and singular the hereditaments and appurtenances thereunto belonging or in anywise appertaining, and the reversion and reversions, remainder and remainders, rents, issues and profits thereof, and all the estate, right, title, interest, claim and demand whatsoever of the grantor, either in law or equity, of, in and to the above bargained premises, with the hereditaments and appurtenances.

TO HAVE AND TO HOLD the said premises above bargained and described, with the appurtenances, unto the grantee, its successors and assigns forever. And the grantor, for himself, his heirs and personal representatives, does covenant, grant, bargain and agree to and with the grantee, its successors and assigns, that at the time of the ensembling and delivery of these presents, he is well seized of the premises above conveyed, has good, sure, perfect, absolute and indefeasible estate of inheritance, in law, in fee simple, and has good right, full power and lawful authority to grant, bargain, sell and convey the same in manner and form as aforesaid, and that the same are free and clear from all former and other grants, bargains, sales, liens, taxes, assessments, encumbrances and restrictions of whatever kind or nature soever, except 1) Taxes for the current year not yet due and 2) Conditions, restrictions, rights, rights of way, and easements of record.

The grantor shall and will WARRANT AND FOREVER DEFEND the above-bargained premises in the quiet and peaceable possession of the grantee, its successors and assigns, against all and every person or persons lawfully claiming the whole or any part thereof.

The singular number shall include the plural, the plural the singular, and the use of any gender shall be applicable to all genders.

IN WITNESS WHEREOF, The grantor has executed this deed on the date set forth above.

[See attached signature page and

acknowledgements]

STATE OF COLORADO
County of _____

ss.

The foregoing instrument was acknowledged before me this _____ day of _____, 19 _____

by _____
My commission expires _____

WITNESS my hand and official seal.

Notary Public

*If in Denver, insert "City and."

AF 217721

No. _____

WARRANTY DEED

Storage Equities, Inc. and
PS Partners VII, Ltd., a
California Limited Partnership

TO

Storage Equities /
PS Partners VII - Sheridan

STATE OF COLORADO,

County of _____ } ss.

I hereby certify that this instrument was filed for record in my
office this _____ day of _____, 19____

at _____ o'clock _____ M., and duly recorded

in Book _____, Page _____

Run No. _____ Reception No. _____

Recorder

By _____ Deputy

Fees, \$ _____

BRADFORD PUBLISHING CO.

2017

LEGAL DESCRIPTION

24

THAT PART OF THE SOUTHWEST 1/4 OF THE SOUTHWEST 1/4 OF SECTION 6, TOWNSHIP 4 SOUTH, RANGE 68 WEST OF THE 6TH P.M., AND MORE PARTICULARLY DESCRIBED AS FOLLOWS:

BEGINNING AT A POINT 195 FEET NORTH AND 110 FEET EAST OF THE SOUTHWEST CORNER OF SAID SECTION 6; THENCE NORTH 0 DEGREES 02 MINUTES EAST, AND PARALLEL TO THE WEST LINE OF SAID SOUTHWEST 1/4, 466.6 FEET; THENCE NORTH 89 DEGREES 12 MINUTES 30 SECONDS WEST, 60 FEET, THENCE NORTH 0 DEGREES 02 MINUTES EAST, AND PARALLEL TO THE WEST LINE OF SAID SOUTHWEST 1/4 88.8 FEET; THENCE SOUTH 89 DEGREES 12 MINUTES 30 SECONDS EAST, 445 FEET, THENCE SOUTH 0 DEGREES 02 MINUTES WEST, 88.8 FEET THENCE SOUTH 89 DEGREES 12 MINUTES 30 SECONDS EAST, 157.46 FEET; THENCE SOUTH 0 DEGREES 07 MINUTES 30 SECONDS EAST, 493 FEET; THENCE NORTH 89 DEGREES 58 MINUTES WEST, 463.78 FEET; THENCE NORTH 0 DEGREES 02 MINUTES EAST, 32.5 FEET; THENCE NORTH 89 DEGREES 12 MINUTES WEST, 80 FEET MORE OR LESS TO THE POINT OF BEGINNING. CITY AND COUNTY OF DENVER, STATE OF COLORADO.

TOGETHER WITH THE RIGHTS CREATED IN THAT CERTAIN EASEMENT DATED JULY 24, 1978, AND RECORDED AUGUST 11, 1978, IN BOOK 1724 AT PAGE 448, DENVER COUNTY RECORDS, COLORADO.

EXHIBIT A

MH/dc/3/016

34

STORAGE EQUITIES, INC.,
a California corporation

By: Betty R. Hurn
Betty R. Hurn
Vice President

By: Hugh W. Horne
Hugh W. Horne
Secretary

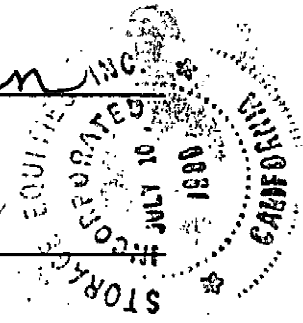

PS PARTNERS VII, LTD.,
A CALIFORNIA LIMITED PARTNERSHIP

By: PSI Associates II, Inc.
a California corporation
Its General Partner

By: Betty R. Hurn
Betty R. Hurn
Vice President

By: Hugh W. Horne
Hugh W. Horne
Secretary

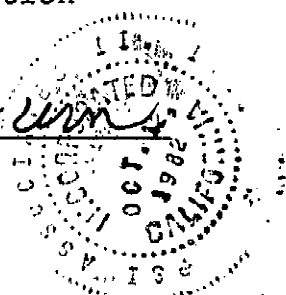

EFH/dc/14/56

STATE OF CALIFORNIA)
) SS.
COUNTY OF LOS ANGELES)

On December 18, 1986, before me, the undersigned, a Notary Public in and for said State, personally appeared Betty R. Hurn, personally known to me or proved to me on the basis of satisfactory evidence to be the person who executed the within instrument as the Vice President, and Hugh W. Horne, personally known to me or proved to me on the basis of satisfactory evidence to be the person who executed the within instrument as the Secretary of Storage Equities, Inc., the corporation that executed the within instrument, and that such corporation executed the within instrument pursuant to its bylaws or a resolution of its board of directors.

WITNESS my hand and official seal.

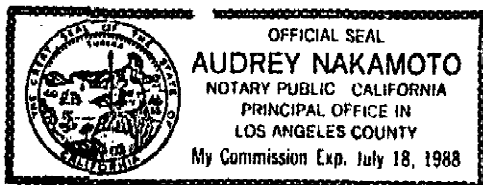

Audrey Nakamoto
Notary Public in and for the
State of California

STATE OF CALIFORNIA)
) SS.
COUNTY OF LOS ANGELES)

On December 18, 1986, before me, the undersigned, a Notary Public in and for said State, personally appeared Betty R. Hurn, personally known to me or proved to me on the basis of satisfactory evidence to be the person who executed the within instrument as the Vice President, and Hugh W. Horne, personally known to me or proved to me on the basis of satisfactory evidence to be the person who executed the within instrument as the Secretary of PSI Associates II, Inc., the corporation that executed the within instrument on behalf of PS Partners VII, Ltd., a California Limited Partnership, the limited partnership that executed the within instrument, and that such corporation executed the same as such partner and that such limited partnership executed the same.

WITNESS my hand and official seal.

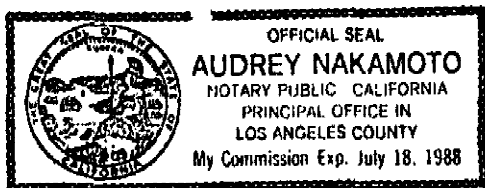

Audrey Nakamoto
Notary Public in and for the
State of California

EFH/dc/14/057

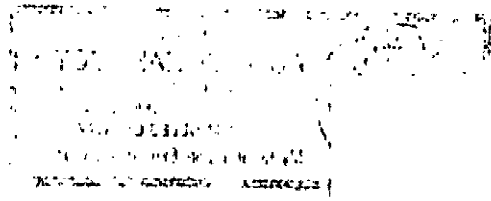
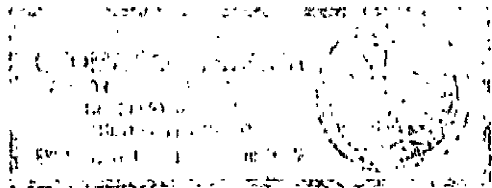

ELIZABETH HUNSAKER
Sachs & Phelps
1925 Century Park East
Los Angeles, Calif. 90067

F.J. SERAFINI
 COUNTY CLERK
 DENVER COUNTY
 1724 448

SEWER EASEMENT

012.00 A ☺

THIS AGREEMENT made and entered into this 24th day of July, 1978, by and between Hans Philipp, Mrs. H. Philipp, Carol Kline, and Rotterdam Holdings, Ltd., a British Columbia corporation, whose address is c/o Chester P. Schwartz, 1715 United Bank Center, 1700 Broadway, Denver, Colorado 80290, hereinafter collectively referred to as "Grantors", and SHERIDAN MINI STORAGE, a limited partnership, whose address is 5005 East Evans Avenue, Denver, Colorado, hereinafter referred to as "Grantee."

R E C I T A L S

The Grantor and Grantee own adjoining parcels which parcels are described in Exhibit A attached hereto and incorporated herein. Grantee is desirous of acquiring a sewer easement through the Grantor's property as hereinafter described. The Grantor is willing to grant such an easement upon the terms and conditions hereinafter set forth.

NOW, THEREFORE, the following grants and agreements are made in consideration of Ten Dollars (\$10.00) and other valuable consideration, the receipt in sufficiency of which are hereby acknowledged.

1. Grant of Easement. Grantor hereby grants to Grantee, its successors and assigns, an Easement for the use and construction of a sewer used primarily as a storm sewer on a strip of land not exceeding ten feet in width described as follows:

1724 448

A strip of land 20.00 feet wide lying 10.00 feet either side of the following described centerline located in the Southwest one-quarter of Section 6, Township 4 South, Range 68 West of the 6th P.M., City and County of Denver, State of Colorado, more particularly described as follows:

Commencing at the Northwest corner of Sheridan Mini Storage a recorded P.B.G. in the City and County of Denver; thence South $89^{\circ}12'30''$ east along the North Boundary of said Sheridan Mini Storage P.B.G. 290.50 feet to the point of beginning, said point being 15.50 feet easterly of the Southwest corner of an existing apartment project; thence North $0^{\circ}02'00''$ East parallel with the west line of the Southwest one-quarter of said Section 6 a distance of 343 feet more or less to the point of terminus of the herein described strip of land, said point being the flow line of Lakewood Gulch.

2. Use of Easement Premises. Grantee shall be entitled to the right of ingress and egress to and from such sewer for the installation, maintenance and repair of the same. At all times, Grantee shall construct and maintain such sewer in such fashion so as to cause a minimal disruption to the traffic flow on the property of Grantor. At all times during such maintenance and construction, access to all areas of Grantor's property shall be maintained.

3. Maintenance of Easement Premises. Grantee covenants promptly to improve the easement premises with a black-topped surface which surface Grantee covenants and agrees to maintain and repair at its sole cost and expense. Further, Grantee covenants and agrees that it will maintain and repair such sewer line in a good workmanlike manner in perpetuity. Grantee shall have the right of ingress and egress at any reasonable time for purposes of maintenance and repair of the sewer line or the surface over such sewer line.

1724 449

4. Running of Benefits and Burdens. All provisions of this Agreement, including the benefits and burdens, run with the land and are binding upon and shall inure to the benefit of the respective heirs, assigns, successors and personal representatives of the parties.

5. Attorney's Fees. Either party may enforce this instrument by appropriate action and, in the event that he prevails in such action, he shall recover as part of his costs a reasonable attorney's fee.

IN WITNESS WHEREOF, the party of this Agreement is executed as of the date first above written.

GRANTOR:

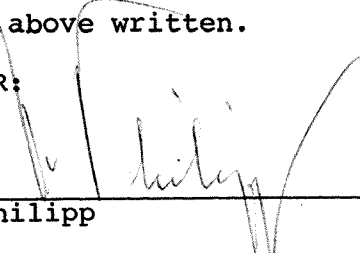

Hans Philipp



Mrs. H. Philipp



Carol Kline

ROTTERDAM HOLDINGS, LTD.

By: 

President

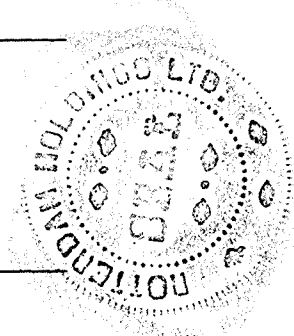

GRANTEE:

SHERIDAN MINI STORAGE,
a Limited Partnership

By: 

General Partner

1724 450

CITY OF VANCOUVER)
)
) SS
PROVINCE OF BRITISH COLUMBIA)

The foregoing instrument was acknowledged before me this 24th day of July, 1978, by Hans Philipp.
Witness my hand and official seal.
My commission expires: N/A



Notary Public

CITY OF VANCOUVER)
)
) SS
PROVINCE OF BRITISH COLUMBIA)

NISSON N. GOLDMAN
Barrister & Solicitor
Notary Public
within British Columbia



The foregoing instrument was acknowledged before me this 24th day of July, 1978, by Mrs. H. Philipp.
Witness my hand and official seal.
My commission expires: N/A



Notary Public

CITY OF VANCOUVER)
)
) SS
PROVINCE OF BRITISH COLUMBIA)

NISSON N. GOLDMAN
Barrister & Solicitor
Notary Public
within British Columbia

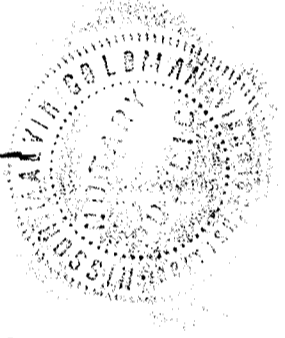

The foregoing instrument was acknowledged before me this 24th day of July, 1978, by Carol Kline.
Witness my hand and official seal.
My commission expires: N/A

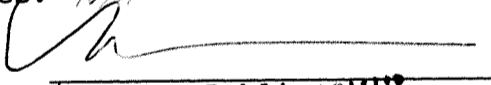

Notary Public

CITY OF VANCOUVER)
)
) SS
PROVINCE OF BRITISH COLUMBIA)

NISSON N. GOLDMAN
Barrister & Solicitor
Notary Public
within British Columbia



The foregoing instrument was acknowledged before me this 24th day of July, 1978, by Ies van Messel, President, and ----- Secretary of Rotterdam Holdings, Ltd. a British Columbia corporation.
Witness my hand and official seal.
My commission expires: N/A

Notary Public
NISSON N. GOLDMAN
Barrister & Solicitor
Notary Public
within British Columbia



1724 451

STATE OF COLORADO)
) SS
CITY AND COUNTY OF DENVER)

The foregoing instrument was acknowledged before me
this 9th day of August, 1978 by Sherid M. Greenberg,
as general partner of Sheridan Mini Storage, a Limited
Partnership.

Witness my hand and official seal.

My commission expires: 2/23/82

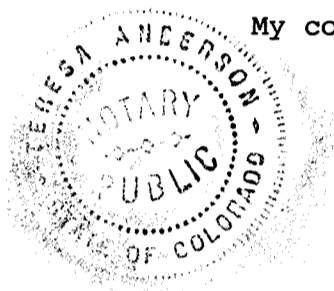

Theresa Anderson
Notary Public

1724 452

DATE: JULY 11, 1978



MILLER - ERNSTSEN AND ASSOC., INC.

JOB NO. 675-A

CIVIL AND LAND DEVELOPMENT ENGINEERING
LAND SURVEYING
758-7117

HOLLY PLAZA
SUITE 204

2120 S. HOLLY STREET
DENVER, COLORADO 80222

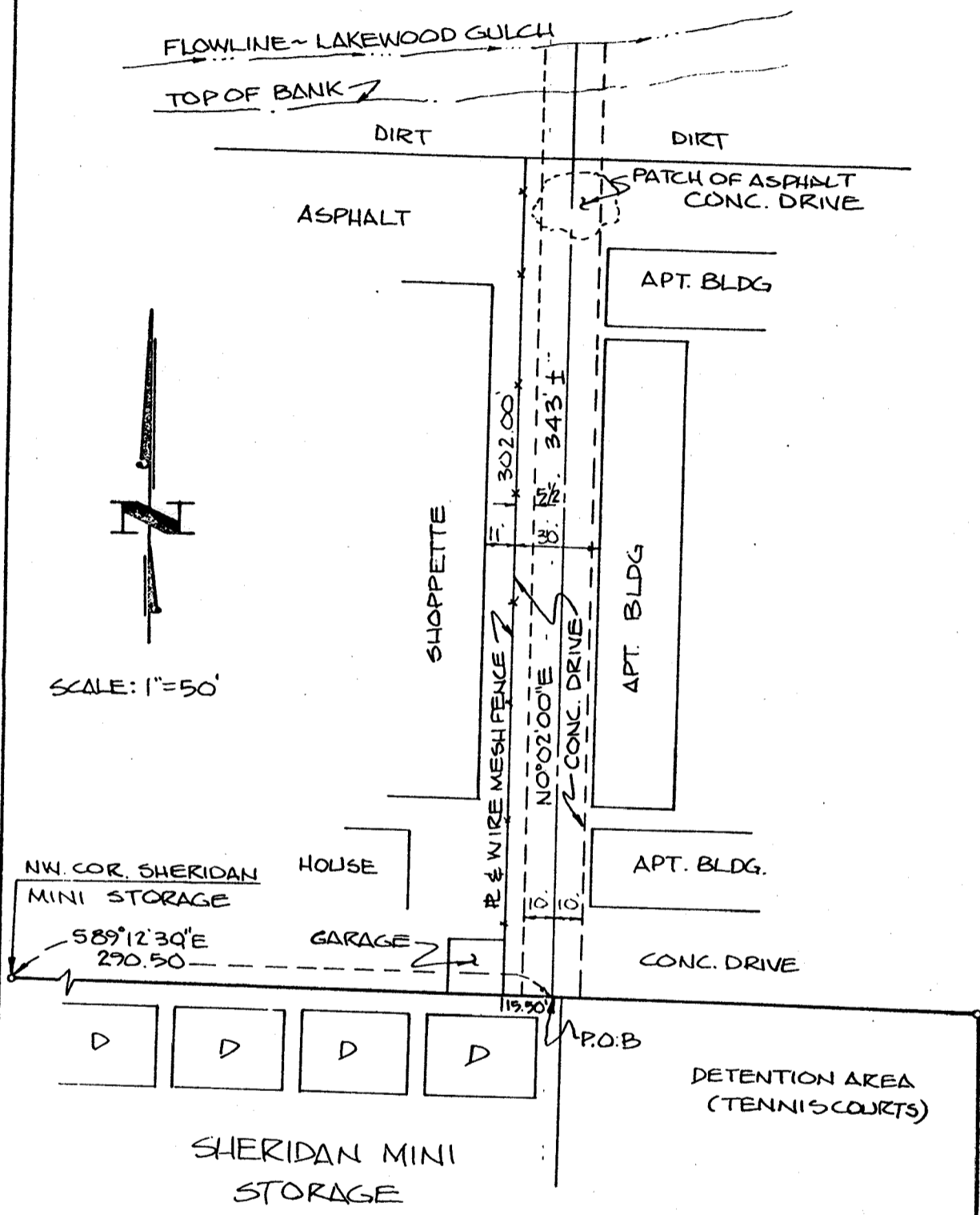

SCALE: 1"=50'

LEGAL DESCRIPTION

A STRIP OF LAND 20.00 FEET WIDE LYING 10.00 FEET EITHER SIDE OF THE FOLLOWING DESCRIBED CENTERLINE LOCATED IN THE SOUTHWEST ONE-QUARTER OF SECTION 6, TOWNSHIP 4 SOUTH, RANGE 68 WEST OF THE 6TH P.M., CITY AND COUNTY OF DENVER, STATE OF COLORADO, MORE PARTICULARLY DESCRIBED AS FOLLOWS:

COMMENCING AT THE NORTHWEST CORNER OF SHERIDAN MINI STORAGE A RECORDED P.B.G. IN THE CITY AND COUNTY OF DENVER; THENCE SOUTH 89°12'30" EAST ALONG THE NORTH BOUNDARY OF SAID SHERIDAN MINI STORAGE P.B.G. 290.50 FEET TO THE POINT OF BEGINNING, SAID POINT BEING 15.50 FEET EASTERLY OF THE SOUTHWEST CORNER OF AN EXISTING APARTMENT PROJECT; THENCE NORTH 0°02'00" EAST PARALLEL WITH THE WEST LINE OF THE SOUTHWEST ONE-QUARTER OF SAID SECTION 6 A DISTANCE OF 343 FEET MORE OR LESS TO THE POINT OF TERMINUS OF THE HEREIN DESCRIBED STRIP OF LAND, SAID POINT BEING THE FLOW LINE OF LAKEWOOD GULCH.

EXHIBIT A

1724 453

SHERIDAN MINI STORAGE

A PLANNED UNIT DEVELOPMENT LOCATED AT THE NORTHEAST CORNER OF THE INTERSECTION OF WEST SIXTH AVENUE AND SHERIDAN BOULEVARD IN THE SOUTHWEST ONE-QUARTER OF THE SOUTHWEST ONE-QUARTER OF SECTION 6, TOWNSHIP 4 SOUTH, RANGE 68 WEST OF THE SIXTH PRINCIPAL MERIDIAN, IN THE CITY AND COUNTY OF DENVER, STATE OF COLORADO
 P.U.D. APPROVED BY ORDINANCE NO. 613 OF 1977

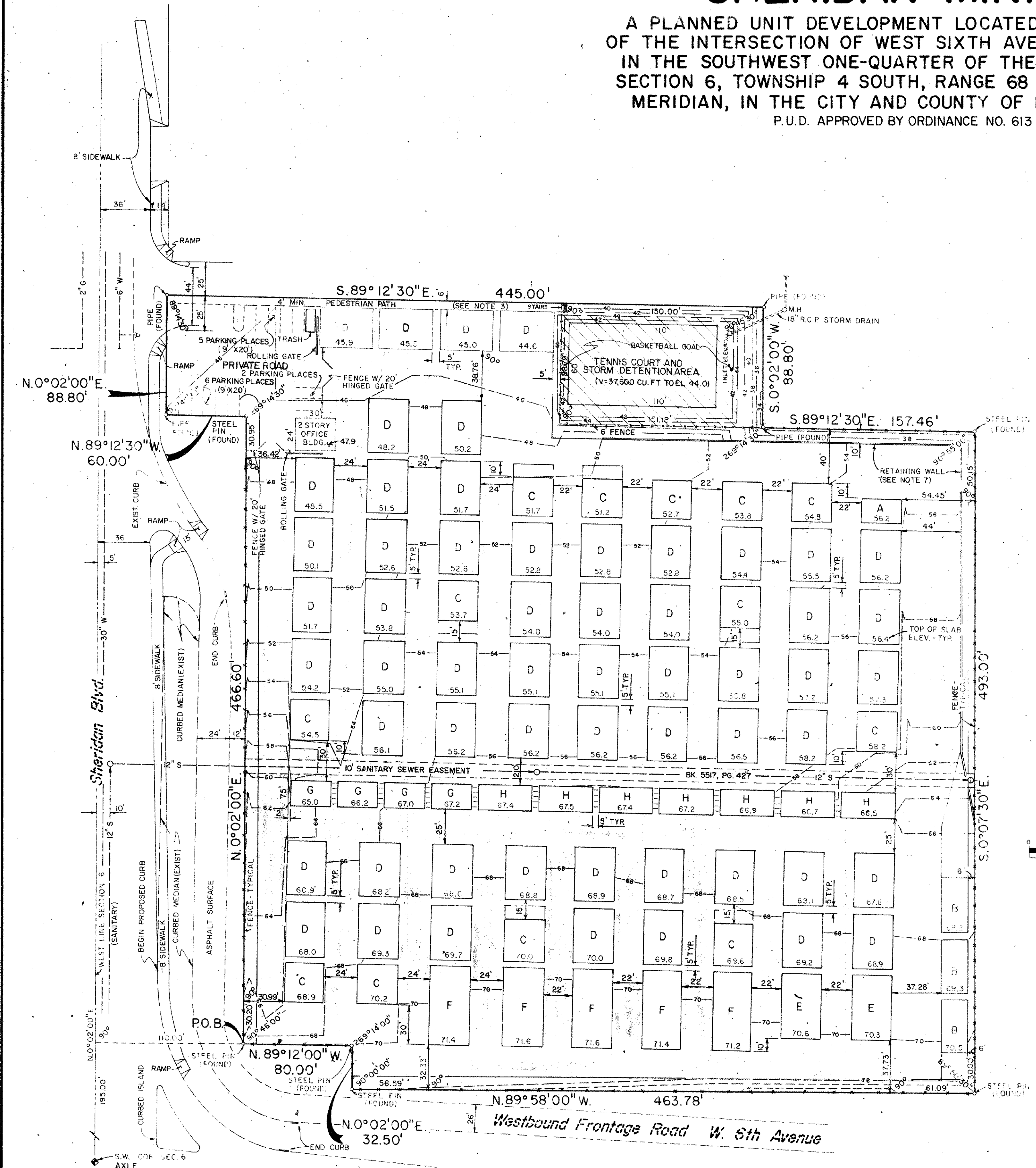

LEGAL DESCRIPTION

THAT PART OF THE SOUTHWEST ONE-QUARTER OF THE SOUTHWEST ONE-QUARTER OF SECTION 6, TOWNSHIP 4 SOUTH, RANGE 68 WEST OF THE SIXTH PRINCIPAL MERIDIAN, IN THE CITY AND COUNTY OF DENVER, STATE OF COLORADO, AND MORE PARTICULARLY DESCRIBED AS FOLLOWS:
 COMMENCING AT THE SOUTHWEST CORNER OF SAID SECTION 6; THENCE NORTH 0°02'00" EAST, AND ALONG THE WEST LINE OF SAID SOUTHWEST ONE-QUARTER A DISTANCE OF 195.60 FEET; THENCE ON AN ANGLE TO THE RIGHT OF 90° 30'00", A DISTANCE OF 110.00 FEET TO THE POINT OF BEGINNING; THENCE NORTH 0°02'00" EAST AND PARALLEL WITH THE WEST LINE OF SAID SOUTHWEST ONE-QUARTER 465.60 FEET; THENCE NORTH 89°12'30" WEST, 60.00 FEET; THENCE NORTH 0°02'00" EAST AND PARALLEL WITH THE WEST LINE OF SAID SOUTHWEST ONE-QUARTER, 88.80 FEET; THENCE SOUTH 89°12'30" EAST, 445.00 FEET; THENCE SOUTH 0°02'00" WEST 88.80 FEET; THENCE SOUTH 89°12'30" WEST, 127.44 FEET; THENCE SOUTH 0°02'00" EAST, 493.00 FEET; THENCE NORTH 89°58'00" WEST, 463.78 FEET; THENCE NORTH 0°02'00" EAST AND PARALLEL WITH THE WEST LINE OF SAID SOUTHWEST ONE-QUARTER, 32.50 FEET; THENCE NORTH 89°58'00" WEST 80.00 FEET TO THE POINT OF BEGINNING, CONTAINING 7.038 ACRES.

SURVEYOR'S CERTIFICATE

I, ROBERT L. HOLZEL, REGISTERED LAND SURVEYOR IN THE STATE OF COLORADO, DO HEREBY CERTIFY THAT THE SURVEY OF SHERIDAN MINI STORAGE WAS MADE UNDER MY SUPERVISION AND THE ACCOMPANYING PLAT ACCURATELY AND PROPERLY SHOWS SAID SURVEY.

Robert L. Holz
 ROBERT L. HOLZEL, REGISTERED LAND SURVEYOR NO. 13502

STATE OF COLORADO
 CITY AND COUNTY OF DENVER, SS 037641

I HEREBY CERTIFY THAT THIS INSTRUMENT WAS FILED FOR RECORD IN MY OFFICE AT 10:38 O'CLOCK A.M. ON THE 7th DAY OF April A.D. 1978 AND DULY RECORDED IN PLANNED DEVELOPMENT BOOK

F. J. Serafini
 CLERK AND RECORDER

BY *Louis May Howard* DEPUTY FEE \$10.00

APPROVED BY *A. H. Jensen* DATE 4/4/78
 PLANNING ADMINISTRATOR

APPROVED BY *Alan L. Cantel* DATE 4/4/78
 PLANNING DIRECTOR

GENERAL NOTES

- BENCH MARK - WEST 9TH AVENUE AT SHERIDAN: "4" ON STEP, SOUTH SIDE OF HOUSE ON NORTHEAST CORNER 175.83 DENVER DATUM.
- ALL BOUNDARY CORNERS ARE AS SHOWN ON DRAWING.
- THE 6 FOOT WIDE PEDESTRIAN PATH (4" MIN.) LEADING FROM SHERIDAN BOULEVARD TO THE TENNIS COURT AND STORM DETENTION AREA ALONG THE NORTH BOUNDARY OF THIS PROPERTY IS FOR PUBLIC ACCESS TO AND FROM THE TENNIS COURT AREA.
- BEARINGS ARE BASED ON THE WEST LINE OF THE SOUTHWEST ONE-QUARTER OF SECTION 6 AS BEING NORTH 0°02'00" EAST PER STATE HIGHWAY DEPARTMENT INFORMATION.
- PARKING SPACES ARE 9 FOOT BY 20 FOOT.
- PLANTING PLAN IN PLANNING OFFICE FILES.
- RETAINING WALL WILL VARY IN HEIGHT FROM 1' TO 10'.
- SEE PLAN AND REVISION AREA.

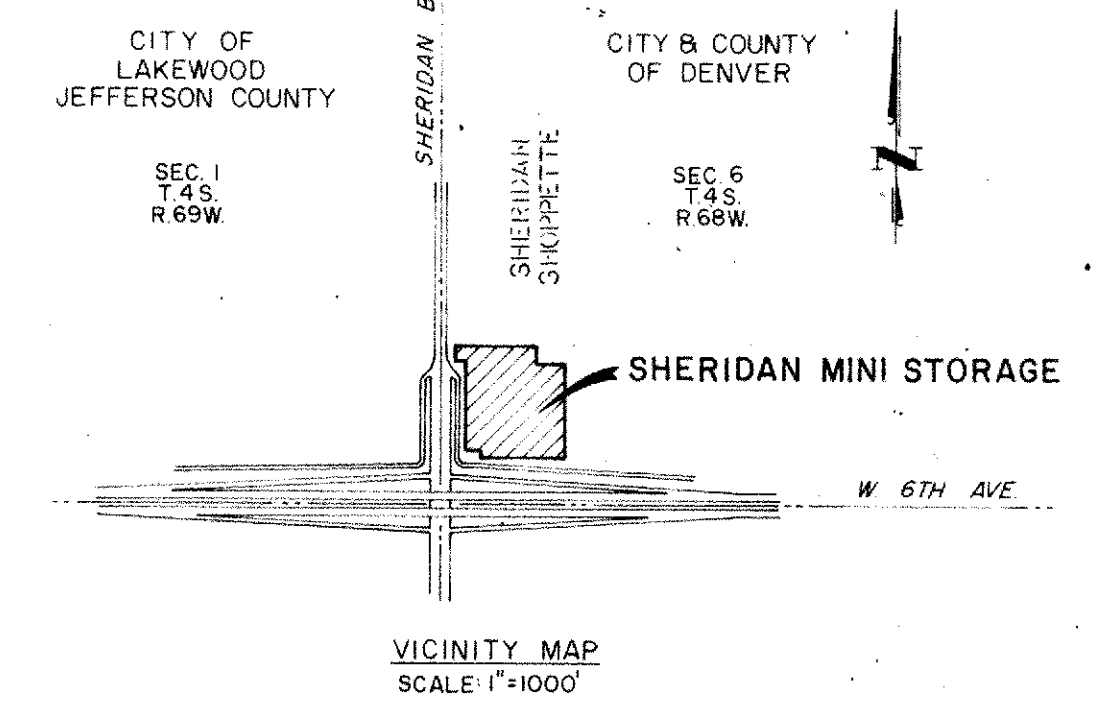

BUILDING TABULATION

TYPE	SIZE	LEVELS
A	20' x 30'	SINGLE STORY
B	20' x 40'	" "
C	30' x 30'	" "
D	30' x 40'	" "
E	30' x 50'	" "
F	30' x 60'	" "
G	20' x 30'	TWO LEVELS
H	20' x 40'	" "

TYPICAL CURB CUT DETAIL

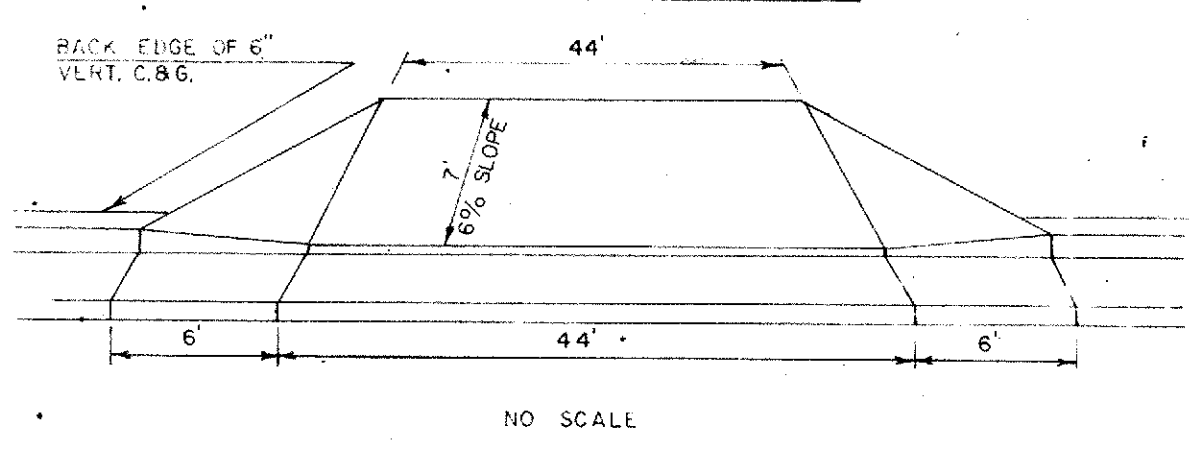

SIDEWALK RAMP DETAIL

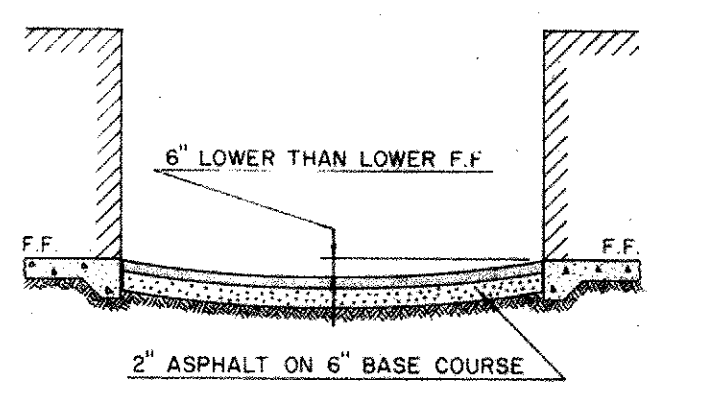
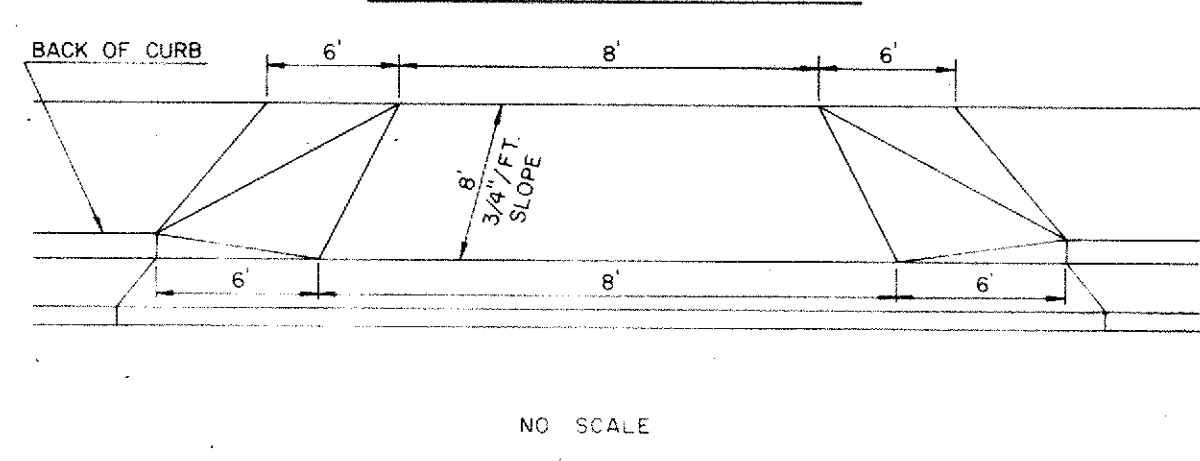

STATE OF COLORADO
CITY AND COUNTY
OF DENVER
FILED IN MY OFFICE

NOV 2 AM 19 23

8430 417

EASEMENT GRANT IN PRIVATE ROADS

RECORDED IN

BOOK PAGE

LOUISIANA

WHEREAS, JOHN E. RUNYAN, ALBERT R. RUNYAN and RAYMOND J. RUNYAN (hereinafter called Grantors) are the sole owners of all of the parcels of land comprising the following-described entire parcel of realty situated in the City and County of Denver, State of Colorado, to-wit:

That part of North 1/2 of SW $\frac{1}{4}$ of SW $\frac{1}{4}$ of Section 6, Township 4 South, Range 68 West described as follows: Beginning at a point on the North line of said SW $\frac{1}{4}$ of SW $\frac{1}{4}$, 822.76 feet East of Northwest corner of said SW $\frac{1}{4}$ of SW $\frac{1}{4}$ of Section 6, thence South parallel to West line of said SW $\frac{1}{4}$ of SW $\frac{1}{4}$ 665 feet to a point 660 feet North of South line of SW $\frac{1}{4}$ of SW $\frac{1}{4}$ of said Section, thence East 489.91 feet; thence North 666.1 feet, thence West 489.91 feet to beginning. Excepting that part thereof lying within the South 1/2 of SW $\frac{1}{4}$ of SW $\frac{1}{4}$ of said Section 6, if any, and Except that part described in Book 8379 Page 114;

also

The South 1/2 of the following-described tract of land: That part of the SW $\frac{1}{4}$ SW $\frac{1}{4}$ of Section 6, Township 4 South, Range 68 West, described as follows: Beginning at a point on the North line and 495 feet East of the Northwest corner of said SW $\frac{1}{4}$ SW $\frac{1}{4}$; thence South and parallel with the West line of said SW $\frac{1}{4}$ SW $\frac{1}{4}$, 664 feet to a point 660 feet North of the South line of said SW $\frac{1}{4}$ SW $\frac{1}{4}$; thence East and parallel with and 660 feet North of said South line of SW $\frac{1}{4}$ SW $\frac{1}{4}$, 327.76 feet; thence North 665 feet to the North line of said SW $\frac{1}{4}$ SW $\frac{1}{4}$; thence West 327.76 feet to the point of beginning

except for that portion previously deeded to the City and County of Denver as described in deed recorded in Book 8779 at page 114 of the records in the office of the Clerk and Recorder, Denver, Colorado, and except for that portion transferred by conveyance of even date herewith by John E. Runyan to Gordon M. Ferguson, and more particularly described as follows:

That part of the NE $\frac{1}{4}$ SW $\frac{1}{4}$ SW $\frac{1}{4}$ of Section 6, in Township 4 South, Range 68 West of the 6th P.M. in the City and County of Denver and State of Colorado described as Commencing at the Southeast corner of said NE $\frac{1}{4}$ SW $\frac{1}{4}$ SW $\frac{1}{4}$ of said Section 6; running thence Westerly along its South line 194 feet; thence North and parallel with its East line 30 feet to the true point of beginning on the North edge of a private road; thence continuing along said line, parallel

NOV-259 494659

STATE OF COLORADO
CITY AND COUNTY
OF DENVER
FILED IN MY OFFICE ON

NOV 2 AM 10 28

EASEMENT GRANT IN PRIVATE ROADS

RECORDED IN BOOK PAGE

BOOK PAGE

LOUIS S. MIDDLEBURY
RECORDER

WHEREAS, JOHN E. RUNYAN, ALBERT R. RUNYAN and RAYMOND J. RUNYAN (hereinafter called Grantors) are the sole owners of all of the parcels of land comprising the following-described entire parcel of realty situated in the City and County of Denver, State of Colorado, to-wit:

That part of North 1/2 of SW 1/4 of SW 1/4 of Section 6, Township 4 South, Range 68 West described as follows: Beginning at a point on the North line of said SW 1/4 of SW 1/4, 822.76 feet East of Northwest corner of said SW 1/4 of SW 1/4 of Section 6, thence South parallel to West line of said SW 1/4 of SW 1/4 665 feet to a point 660 feet North of South line of SW 1/4 of SW 1/4 of said Section, thence East 489.91 feet; thence North 666.1 feet, thence West 489.91 feet to beginning. Excepting that part thereof lying within the South 1/2 of SW 1/4 of SW 1/4 of said Section 6, if any, and Except that part described in Book 8379 Page 114;

also

The South 1/2 of the following-described tract of land: That part of the SW 1/4 SW 1/4 of Section 6, Township 4 South, Range 68 West, described as follows: Beginning at a point on the North line and 495 feet East of the Northwest corner of said SW 1/4 SW 1/4; thence South and parallel with the West line of said SW 1/4 SW 1/4, 664 feet to a point 660 feet North of the South line of said SW 1/4 SW 1/4; thence East and parallel with and 660 feet North of said South line of SW 1/4 SW 1/4, 327.76 feet; thence North 665 feet to the North line of said SW 1/4 SW 1/4; thence West 327.76 feet to the point of beginning

except for that portion previously deeded to the City and County of Denver as described in deed recorded in Book 8779 at page 114 of the records in the office of the Clerk and Recorder, Denver, Colorado, and except for that portion transferred by conveyance of even date herewith by John E. Runyan to Gordon M. Ferguson, and more particularly described as follows:

That part of the NE 1/4 SW 1/4 SW 1/4 of Section 6, in Township 4 South, Range 68 West of the 6th P.M. in the City and County of Denver and State of Colorado described as Commencing at the Southeast corner of said NE 1/4 SW 1/4 SW 1/4 of said Section 6; running thence Westerly along its South line 194 feet; thence North and parallel with its East line 30 feet to the true point of beginning on the North edge of a private road; thence continuing along said line, parallel

NOV-259 494659 131-113

with the aforesaid East line 134 feet; thence westerly at right angles with the aforesaid East line (the North-South centerline of the SW $\frac{1}{4}$ of Section 6 and the centerline of Wolff Street) 339.3 feet; thence Southerly and parallel with Wolff Street 128.43 feet more or less to a point on the North line of the aforesaid private road 30 feet North of the South line of the NE $\frac{1}{4}$ SW $\frac{1}{4}$ SW $\frac{1}{4}$; thence Easterly and parallel with said South line 339.35 feet more or less to the true point of beginning. Except those parts of the above at Southwest and Southeast corners thereof that lie outside of two 24-foot-radius circles that are tangent to the South, West and East boundaries of the land herein described; and

WHEREAS, Grantors have caused to be laid out certain private streets more specifically shown and described on the attached plat of survey, reflecting a survey conducted October 24, 1959, said plat having been prepared by Herbert K. Linn, Professional Engineer and Land Surveyor (said plat of survey being expressly incorporated herein);

NOW, THEREFORE, in consideration of Ten Dollars and other good and valuable consideration, the receipt of which is hereby acknowledged, Grantors do hereby grant and convey unto Gordon M. Ferguson an easement of way over all the private roads shown on the attached plat of survey for the purpose of full and unrestricted use for ingress and egress to and from the property conveyed to Gordon M. Ferguson by deed of even date herewith as more particularly described above, it being the intent of Grantors that said right of way shall be appurtenant to said property conveyed to Gordon M. Ferguson and that it shall include the right of the assigns, tenants, licensees, invitees of the present owner or any subsequent owner of said property to use such private roads for ingress and egress to and from said property with permission of such owner;

PROVIDED, HOWEVER, that the right of way herein granted shall not be exclusive to the grantee, but Grantors do also grant unto each other, their grantees and assigns, a like right of full and unrestricted use of the private roads shown on the attached plat for the purpose of ingress and egress from the various parcels of land contained in the property first described above, and it is understood that said private roads may be used for normal road purposes by the undersigned, their grantees, tenants, licensees, invitees and invitees of others hereby granted permissive use of said private ways.

Grantors mutually covenant and agree to undertake the installation, care, maintenance and repair of the private roads in which they own the fee interest subject to the easements granted hereby. This covenant shall run with the affected property and shall bind the heirs and assigns of Grantors.

with the aforesaid East line 134 feet; thence westerly at right angles with the aforesaid East line (the North-South centerline of the SW $\frac{1}{4}$ of Section 6 and the centerline of Wolff Street) 339.3 feet; thence Southerly and parallel with Wolff Street 128.43 feet more or less to a point on the North line of the aforesaid private road 30 feet North of the South line of the NE $\frac{1}{4}$, SW $\frac{1}{4}$, SW $\frac{1}{4}$; thence Easterly and parallel with said South line 339.35 feet more or less to the true point of beginning. Except those parts of the above at Southwest and Southeast corners thereof that lie outside of two 24-foot-radius circles that are tangent to the South, West and East boundaries of the land herein described; and

WHEREAS, Grantors have caused to be laid out certain private streets more specifically shown and described on the attached plat of survey, reflecting a survey conducted October 24, 1959, said plat having been prepared by Herbert K. Linn, Professional Engineer and Land Surveyor (said plat of survey being expressly incorporated herein);

NOW, THEREFORE, in consideration of Ten Dollars and other good and valuable consideration, the receipt of which is hereby acknowledged, Grantors do hereby grant and convey unto Gordon M. Ferguson an easement of way over all the private roads shown on the attached plat of survey for the purpose of full and unrestricted use for ingress and egress to and from the property conveyed to Gordon M. Ferguson by deed of even date herewith as more particularly described above, it being the intent of Grantors that said right of way shall be appurtenant to said property conveyed to Gordon M. Ferguson and that it shall include the right of the assigns, tenants, licensees, invitees of the present owner or any subsequent owner of said property to use such private roads for ingress and egress to and from said property with permission of such owner;

PROVIDED, HOWEVER, that the right of way herein granted shall not be exclusive to the grantee, but Grantors do also grant unto each other, their grantees and assigns, a like right of full and unrestricted use of the private roads shown on the attached plat for the purpose of ingress and egress from the various parcels of land contained in the property first described above, and it is understood that said private roads may be used for normal road purposes by the undersigned, their grantees, tenants, licensees, invitees and invitees of others hereby granted permissive use of said private ways.

Grantors mutually covenant and agree to undertake the installation, care, maintenance and repair of the private roads in which they own the fee interest subject to the easements granted hereby. This covenant shall run with the affected property and shall bind the heirs and assigns of Grantors.

Regardless of any rights herein bestowed on any one other than the record owners, the record owners of all the property herein described at the time of the execution thereof may, by recorded instrument, duly acknowledged, vary and alter or rescind any or all of the within terms. However, this right shall not be construed to affect the rights of any person or corporation who or which has acquired a security interest in any of those easements prior to recordation of the instrument described above, nor shall it be construed to affect the rights of any grantees acquiring interests in such easements under deeds executed incident to proceedings for foreclosure of such mortgages or deeds of trust.

IN WITNESS WHEREOF, the parties hereto have executed this instrument this 29th day of October, 1959.

John E. Runyan
Albert R. Runyan
Raymond J. Runyan

STATE OF COLORADO }
CITY AND } SS.
COUNTY OF DENVER }

The foregoing instrument was acknowledged before me this 29th day of October, 1959, by John E. Runyan, Albert R. Runyan, and Raymond J. Runyan.

My commission expires DEC 30 1961.

Witness my hand and official seal.

Howell E. Morris
Notary Public.

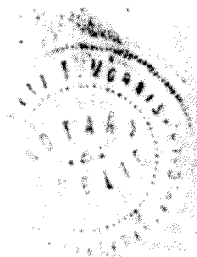

Regardless of any rights herein bestowed on anyone other than the record owners, the record owners of all the property herein described at the time of the execution thereof may, by recorded instrument, duly acknowledged, vary and alter or rescind any or all of the within terms. However, this right shall not be construed to affect the rights of any person or corporation who or which has acquired a security interest in any of those easements prior to recordation of the instrument described above, nor shall it be construed to affect the rights of any grantees acquiring interests in such easements under deeds executed incident to proceedings for foreclosure of such mortgages or deeds of trust.

IN WITNESS WHEREOF, the parties hereto have executed this instrument this 29 day of October, 1959.

John E. Runyan
Albert R. Runyan
Raymond J. Runyan

STATE OF COLORADO)
CITY AND) SS.
COUNTY OF DENVER)

The foregoing instrument was acknowledged before me this 29 day of October, 1959, by John E. Runyan, Albert R. Runyan, and Raymond J. Runyan.

My commission expires DEC 30 1961.

Witness my hand and official seal.

Howell E. Martin
Notary Public.

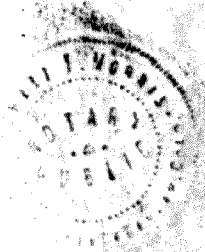

PLAT OF VALLEY PARK.
 IN THE SW⁴ OF THE SW⁴ OF SEC. 6,
 TWP. 4 S., RANGE 68 W., CITY & COUNTY
 OF DENVER, STATE OF COLORADO.

SCALE: 1" = 100'

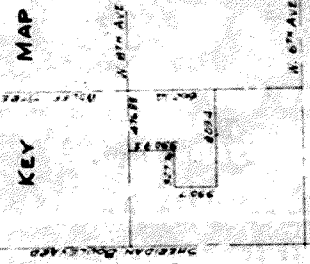

NOTE: THIS MAP SHOWS THE
 POSITIONS OF THE PRIVATE ROADS
 THAT SERVE IMPROVED TRACTS IN
 VALLEY PARK AND ACCESS TO THE
 PUBLIC STREET (WOLFF STREET)

DESIGNED & MAPPED BY
Herbert K. Linn
 HERBERT K. LINN,
 PROFESSIONAL ENGINEER & LAND SURVEYOR
 COLORADO REG. NO. 372
 OCT. 24, 1939

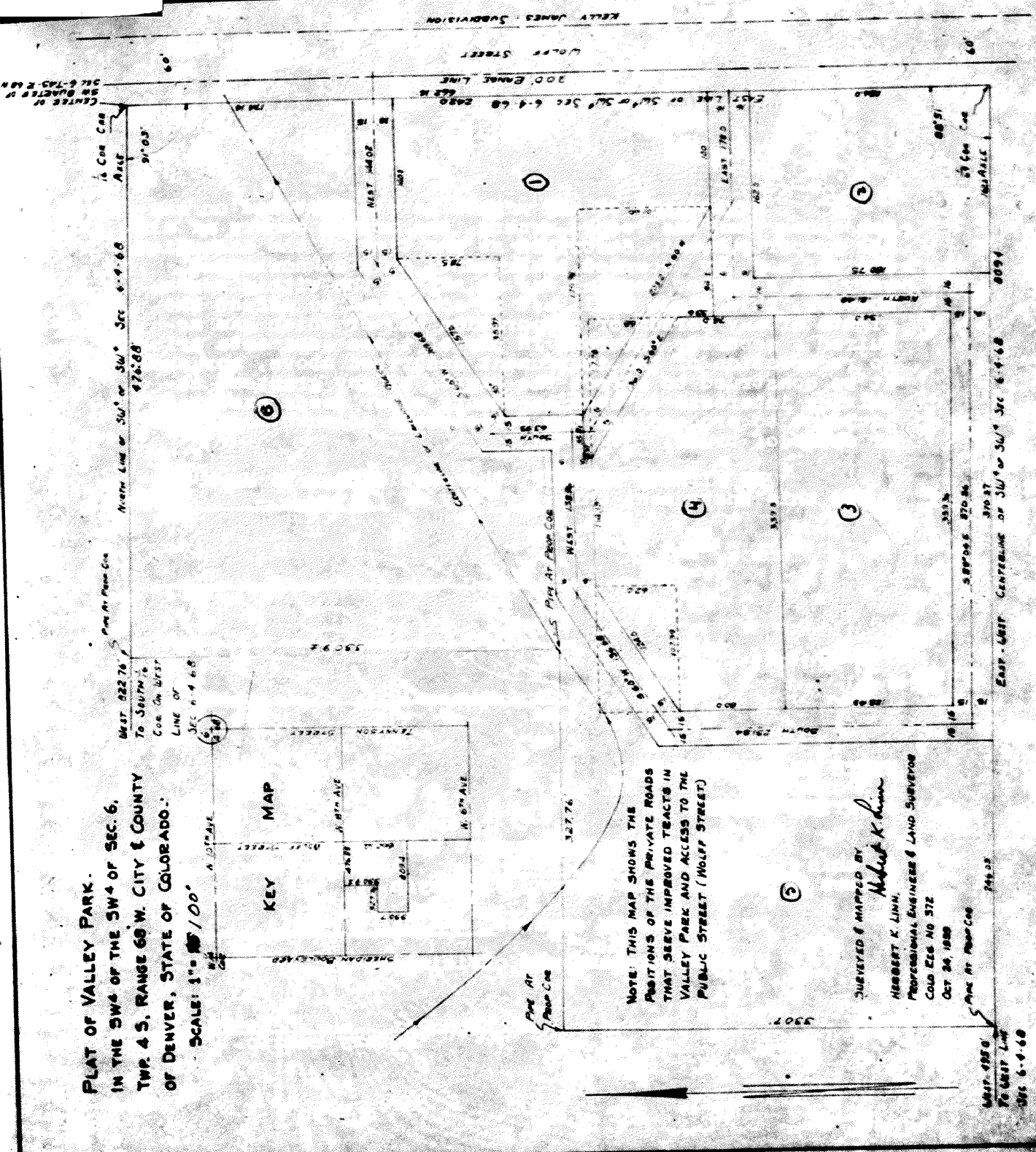

WEST-1/4 SEC. 6
 TO WEST LINE
 SEC. 6-4-68

RIGHT OF WAY AGREEMENT

THIS AGREEMENT, made and entered into as of the 17th day of May, 1941, by and between HARRY F. BAIR, of the City of County of Denver, State of Colorado, hereinafter called "Grantor", and the CITY AND COUNTY OF DENVER, a municipal corporation of the State of Colorado, hereinafter sometimes called "City", WITNESSETH:

For and in consideration of the sum of Five hundred dollars to the Grantor in hand paid by the City, the receipt whereof is hereby acknowledged, the Grantor upon the conditions hereinafter mentioned does hereby grant to the City, its successors and assigns forever, a right of way ten (10) feet in width in which to construct, maintain, repair, replace and operate a sewer line not exceeding twenty-four inches (24") in inside diameter, together with necessary appurtenances, in, through, over, and across the following described parcel of land, situate, lying and being in the City and County of Denver and State of Colorado, to-wit:

That part of the tract of land described as the Southwest One-Quarter (SW $\frac{1}{4}$) of Southwest One-Quarter (SW $\frac{1}{4}$) of Southwest One-Quarter (SW $\frac{1}{4}$) of Section Six (6), Township Four (4) South, Range Sixty-eight (68) West of the Sixth (6th) Principal Meridian (hereinafter called the tract) comprising the five feet on each side of the following described center line, to-wit:

Commencing at a point on the east line of Sheridan Boulevard, 402.07 feet north of the south line of said Section 6; thence east parallel to the south line of said Section 6, a distance of 623 feet more or less to a point on the east line of the tract 402.07 feet north of the southeast corner of the tract.

There is also granted the temporary right to use strips of land ten feet in width on either side of the above described ten-foot strip, during original construction of said line only. Said temporary right shall terminate immediately on completion of said sewer line, and in any event not later than June 30, 1941.

It is mutually covenanted and agreed by and between the parties hereto as follows:

1. The within agreement shall be effective only if the City shall pay to the Grantor within thirty days of the date hereof an additional sum of Seventy nine and 00/100 dollars.

2. The right of way hereby granted is for the construction of a subsurface pipe-line and the use of the surface of the ground only for necessary appurtenances and to install, maintain, repair, replace and operate said pipe-line and appurtenances with the right of ingress and egress to and from said line for said purposes.

3. The City agrees to save and keep the Grantor harmless from all damage caused by maintaining and repairing said pipe-line and appurtenances; that is to say: after said pipe-line and appurtenances shall have been constructed the surface of the ground shall be restored to its natural condition as nearly as may be and thereafter in case of repairs or replacement of said pipe-line or appurtenances any damage done to growing crops or otherwise shall be paid by the City to the Grantor, his successors or assigns.

4. Grantor shall have the use of the surface of said ground except as herein provided.

5. Grantor agrees for himself, his heirs, executors, administrators, successors and assigns not to erect or place any building or plant any tree on said right of way.

6. The City shall, during the time of construction of said pipe-line and appurtenances, erect and maintain gates at all fences crossing said right of way as the said fences are now constructed and shall keep said gates closed.

1. The within agreement shall be effective only if the City shall pay to the Grantor within thirty days of the date hereof an additional sum of *Seventy nine and 00/100* dollars.

2. The right of way hereby granted is for the construction of a subsurface pipe-line and the use of the surface of the ground only for necessary appurtenances and to install, maintain, repair, replace and operate said pipe-line and appurtenances with the right of ingress and egress to and from said line for said purposes.

3. The City agrees to save and keep the Grantor harmless from all damage caused by maintaining and repairing said pipe-line and appurtenances; that is to say: after said pipe-line and appurtenances shall have been constructed the surface of the ground shall be restored to its natural condition as nearly as may be and thereafter in case of repairs or replacement of said pipe-line or appurtenances any damage done to growing crops or otherwise shall be paid by the City to the Grantor, his successors or assigns.

4. Grantor shall have the use of the surface of said ground except as herein provided.

5. Grantor agrees for himself, his heirs, executors, administrators, successors and assigns not to erect or place any building or plant any tree on said right of way.

6. The City shall, during the time of construction of said pipe-line and appurtenances, erect and maintain gates at all fences crossing said right of way as the said fences are now constructed and shall keep said gates closed.

7. If the City, its successors or assigns, shall abandon the right of way herein granted and cease to use the same, all right, title and interest hereunder of the City, its successors or assigns, shall cease and terminate and the Grantor, his successors and assigns, shall hold said premises as the same may then be free from this right of way and shall own all material and structures then on the abandoned strip.

8. It is further agreed that the benefits and burdens and the rights arising under the covenants and grants herein contained shall inure to and be binding upon the legal representatives, heirs, executors, administrators, successors, and assigns of the parties hereto.

IN WITNESS WHEREOF the Grantor has executed the within agreement as of the day and year first above written.

Witness:

Harry F. Bair
Grantor.

Receipt of the above-mentioned seventy-five dollars as the full and final payment due on account of the purchase of the above-mentioned right of way is hereby acknowledged this 12th day of June, 1941.

Harry F. Bair
Grantor.

STATE OF COLORADO

City & County of Denver

ss.

The foregoing instrument and receipt were acknowledged before me by Harry F. Bair, this 12th day of June, 1941.

My Commission Expires: April 25, 1944

Willie Flaks
Notary Public.

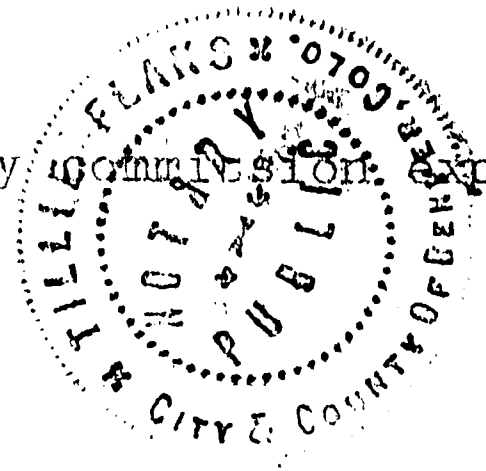

FORM APPROVED:
MALCOLM LINDSEY, Attorney
City and County of Denver,

Malcolm Lindsey
Assistant City Attorney

7. If the City, its successors or assigns, shall abandon the right of way herein granted and cease to use the same, all right, title and interest hereunder of the City, its successors or assigns, shall cease and terminate and the Grantor, his successors and assigns, shall hold said premises as the same may then be free from this right of way and shall own all material and structures then on the abandoned strip.

8. It is further agreed that the benefits and burdens and the rights arising under the covenants and grants herein contained shall inure to and be binding upon the legal representatives, heirs, executors, administrators, successors, and assigns of the parties hereto.

IN WITNESS WHEREOF the Grantor has executed the within agreement as of the day and year first above written.

Witness:

Harry F. Bair
Grantor.

Receipt of the above-mentioned ~~seventy-nine~~ ^{seventy-nine} dollars as the full and final payment due on account of the purchase of the above-mentioned right of way is hereby acknowledged this

12th day of June, 1941.

Harry F. Bair
Grantor.

STATE OF COLORADO

City & County of Denver } ss.

The foregoing instrument and receipt were acknowledged before me by Harry F. Bair, this 12th day of June, 1941.

My commission expires: April 25, 1944

Illie Flaks
Notary Public.

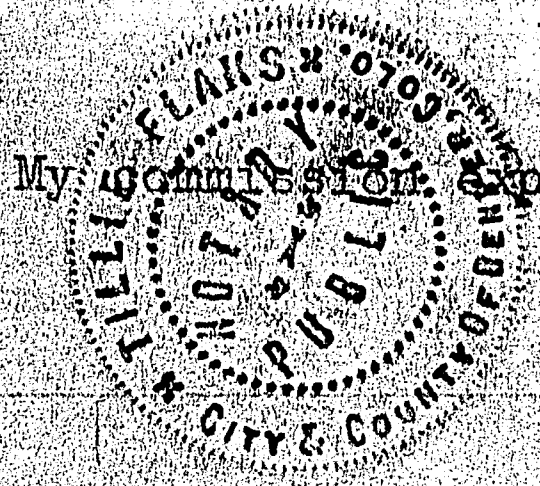

FORM APPROVED
MALCOLM LINDSEY, Attorney
City and County of Denver,

Malcolm Lindsey
Assistant City Attorney

L.T. SERVICE CORP.
521 Fifth Avenue, 23rd Floor
New York, New York 10175
Phone: (212) 599-1300
Fax: (212) 983-2791
E-mail Address: drios@oldrepublictitle.com

April 14, 2017

Sarah Lee You
Public Storage

Re: Special Service No.: CO249370
Property: 680 Sheridan Blvd., Denver, CO
County: Denver
Name: Storage Equities/PS Partners VII - Sherdan, Inc.

I N V O I C E

Search & Exam Fee	\$425.00
Commitment Preparation	<u> N/C </u>
TOTAL TO LT SERVICE:	\$425.00

THE LIABILITY OF THE COMPANY IS LIMITED TO THE FEES PAID TO IT FOR THIS SERVICE

October 13, 2017

Community Planning and Development
City of Denver
201 West Colfax Ave., Dept. 205
Denver, Colorado 80202

Re: 680 Sheridan Blvd – Rezoning Application (Review Criteria)

Dear Rezone Review Team,

The subject site is located at 680 Sheridan Blvd. The existing 7.038 acre site contains approximately 103,200 square feet of single-story buildings. The buildings are primarily self-storage units, accessible by individual exterior doors. The site was originally developed in 1978 and there is an existing PUD that currently governs the site. The PUD, PUD1, limits the maximum square footage to 153,265 or floor area ratio of .5:1. Additionally, no multi-story buildings are permitted under the existing PUD.

The existing site is in disrepair, and because the site was originally built on a land fill, redevelopment of the site entirely remains the only viable option. To make the redevelopment of this site feasible, Public Storage has determined a need for an increased floor area ratio of 3:1 and the ability to build multi-story buildings. In order to increase the floor area ratio and allow for multi-story buildings, we are proposing a Zone Map Amendment. The existing PUD is extremely dated, limiting in scope, and is no longer cohesive with the surrounding neighborhood context or future land use plans. By approving a Zone Map Amendment at this site, the City of Denver will be promoting an investment by a major, long-term land owner/operator allowing an unsalvageable existing development to be revitalized and brought up to current standards.

In March of 2017 the design team met with City Staff to review the pre-application for Zone Map Amendment at this site. We discussed existing zoning, proposed redevelopment, and most effective proposed future zoning. From this meeting, it is believed that code E-MX-3 would be the most appropriate designation for the success of this site in context with the surrounding neighborhood.

Because the proposed redevelopment will maintain the same storage use, the need to request a Zone Map Amendment is not required for a change in use. The need to amend the zone map stems from the inability to redevelop within the limitations put in place by the existing PUD-1. Redevelopment would bring this site into compliance with modern building codes and structural advances.

The site is primarily surrounded by single family, two and multi-unit, commercial, office, and distribution center uses zoned as E-MU, C-MX, U-RH, and R. To the west, is City of Lakewood which is zoned as both mixed use, light industrial and two family/small family residential lots.

Consistency with Adopted Plans

The Villa Park Neighborhood Plan, established in 1991, highlights many goals and plans. These goals include but are not limited to, improving neighborhood arterials, supporting and enhancing commercial

Rezone Application (Review Criteria)
Public Storage – 6th & Sheridan

activity, enhancing the appearance and quality of neighborhood structures, enhancing neighborhood safety, and upgrading neighborhood infrastructure. The vision for business, land use and zoning in Villa Park maintains focus on support for neighborhood commercial activities to remove housing from marginal areas and unblur the lines of maintenance responsibilities of residential homeowners¹.

In the Denver Comprehensive Plan 2000, a vision for Denver and its people, was laid out for incorporation into future development. In this plan, the visions for land-use across the city acknowledge the need for Denver Zoning and related components to be updated, clarified and simplified wherever possible over the course of time. Because this site is governed by the first PUD approved in the City and County of Denver, it remains a perfect candidate for a Map Amendment to rezone the lot and bring the site into compliance with current codes. If this site is not rezoned, it will remain out of date, and out of sync with the surrounding developments that have already been or are proposed to be updated.

To maintain high-quality infill and update the user-friendly nature, this site must be redeveloped. According to this plan, mixed-use zone districts were enacted to create zoning flexibility originally wanted by developers and property owners to provide for more flexibility in use and standards within certain areas. This site remains a true bridge between residential and commercial areas based on physical location. The Storage use, while commercial in nature, serves the needs of local residential population. Public Storage facilities are intended for use by private, individual owners generally located within a three mile radius. Often allowing neighboring residents to accommodate their goods and small business needs without leaving the general vicinity of their homes. This rezone will allow the redeveloped site to more efficiently serve the public community around the highly populated and trafficked area. Without a Map Amendment, this site is not a feasible candidate for redevelopment, and thus will continue to fall out of compliance with the Denver Comprehensive Plan 2000 as the rest of the city progresses².

In 2002, an integrated Land Use and Transportation Plan known as Blueprint Denver was put in to action. Similar to the 2000 Denver Comprehensive Plan, the goal of Blueprint Denver was to shape the City by focusing on land use and transportation. Being right off 6th avenue represents an important location for updated development. One of the first objectives of in this plan aims to clarify and update Denver's zoning ordinance and related ordinances to be consistent with Goals and objects of Denver's Citywide Land Use and Transportation Plan.³ This site and the surrounding population has changed drastically since PUD-1 was approved. Updated access, circulation, attractive architecture and revised foundational elements are desperately needed at this site. The single-family homes near this site will not only enjoy the services offered by Public Storage, but the updated nature of the site will improve the quality of the neighborhood generally. The updates could even have the potential to add value to their privately-owned properties in the future. The infrastructure updates, along with building improvements will provide the neighboring residents with a safe, low-impact commercial property. These types of upgrades add value to the existing and future residential population. As this corridor continues to develop, the facility will even provide a buffer from the noisy Sheridan Blvd. and 6th Ave. corridors. To truly implement Blueprint Denver, revisions to current zoning codes are necessary or streamlining development and imposed regulations.

¹ Villa Park Neighborhood Plan (April 1991)

² Denver Comprehensive Plan 2000

³ Blueprint Denver, 2002 (pg. 3)

Rezone Application (Review Criteria)
Public Storage – 6th & Sheridan

While this area has been identified and recommended for future single-family/duplex, the environmental history of this site (landfill) does not make this potential use feasible. While development of single family/duplex may not be feasible, the redevelopment of this site into a more up to date storage use is compatible with adjacent multi-family uses and in many cases, storage provides a needed service for this type of residential use.

The existing infrastructure is minimally impacted by the proposed development. Both water and sanitary infrastructure elements will be tied into and maintained. Efforts will be made by Public Storage to improve existing infrastructure and its implications to the property. For example, the existing and unused vacated sanitary lines on site propos a potential encumbrance to the land, but also proposed an issue with the City and County of Denver. The existing abandoned line was conveyed through an assignment many years ago with many other lines creating confusion as to the legal standing of these lines. The City working to address and understand these lines, and Public Storage is aiding the City by untangling the ownership details of the abandoned line. Through these legal workings, we will be able to aid the City, clarify ownership with Wastemetro, and generally add value to the site by removing an unnecessary encumbrance. Public Storage has allocated resources and their legal team is working with the Wastemetro Reclamation District's legal team to dedicate the easement and lines so they may be removed properly.

It is also important to note the location of the site, as it sits on the border of both Denver and Lakewood. The proposed Zone Map Amendment allows for compliance with future land use concepts in both City of Lakewood *and* City of Denver. In Lakewood, the west bordering neighbor, Goal I-NA-1 states action steps “to encourage property owners to rehabilitate aging buildings and sites. . .” Lakewood’s Sheridan Station has implemented a Neighborhood Strategy promoting facilitation of business development and sidewalk implementation between 6th Avenue and 10th avenue. In City of Denver, per Blue Print Denver (2002), the proposed redevelopment complies with the Future Street Clarifications of Mixed Use – Arterial and Undesignated local. These classifications support a rezone by adding higher mobility, maintaining lower traffic volumes, and emphasizing local access at lower speeds. The traffic impacts of self-storage facilities represent one of the lowest per square foot trip generators tracked by Institute of Transportation Engineers.

Uniformity of District Regulations

The description of the neighborhood context in the Urban Edge area includes commercial uses located along local, arterial, and main streets. The plan notes that commercial buildings typically have consistent orientation and deep front setbacks to allow for parking and landscaping. Mid-rise commercial is permitted and described in the general context character. The tri level proposed facility is a natural fit across the board.

The proposed Map Amendment to E-MX-3 would prohibit the use of individual entrances to units within a mini-storage facility, thus making the existing site non-compliant in the Urban Edge context. The proposed rezone and subsequent redevelopment eliminates this existing single story drive-up, which does not meet current customer needs or its code compliant. The building would not exceed the E-MX-3 height limit of three stories, further creating cohesive neighborhood context with surrounding properties and uses.

Public Health, Safety & General Welfare

Through the demolition and rebuild process, this project will maintain high standards of compliance with all regulatory agencies. The Total Demolition Guide will be utilized to follow the steps in order to safely demolish existing buildings. Contact will be made, and approvals obtained from the State, Forestry and Landmark Associations, as required. Because the existing site was developed on a landfill that covered the area between 6th and Sheridan and 8th and Wolff, additional care will be taken in the structural design process. The existing building was constructed using standard spread footings and slab on grade construction, which are not sufficient to prevent settling due to the underlying landfill. New buildings can take advantage of a drilled pier and structural scab to provide stability and longevity.

The proposed building provides a more secure scenario for the customers, employees and adjacent neighbors. Elimination of multiple entry units in favor of a single point of entry allows for regulated access by employees and customers. Lighting will provide illumination around the building, deferring criminal activity and vandalism.

Public welfare and general interest is key to the redevelopment of this site. In our efforts to compile an application for Zone Map Amendment, we have had various meetings for community outreach. Our team reached out to the registered neighborhood associations and community leaders. This included discussions with the Denver Neighborhood Association, the Inter-Neighborhood Cooperation and Villa Park Neighborhood Association. Conversations were had discussing the proposed development and how it will affect their members and residents. Overall, the support from the community has been generally positive with an understanding that the existing facility needs to be redeveloped.

Additionally, our team met with Councilman Lopez on July 6, 2017 to discuss the community's needs. He was able to provide background and information on the area surrounding the site. We then met in person with the Villa Park Neighborhood Association. JoAnn Phillips was our point of contact to attend the meeting, and present our proposed redevelopment to the members. We were able to get feedback from the association and discuss concerns. Again, support from the community has been generally positive with an understanding that the existing facility needs to be redeveloped.

Justifying Circumstances

The intersection at 6th and Sheridan represents an area that is generally decay. Generally, the area is dated, and does not maintain many current engineering or planning standards. According to section 12.4.10.8(a) of the Denver Zoning Code, one of the Justifying Circumstances must be met for compliance with additional review. Justifying Circumstance number 4, most relates to this property. This code section requires the land or its surrounding environs to have changed, or be changing to such a degree that it is in public interest to encourage a redevelopment.⁴ The land and surrounding environment has undeniably changed over the years since the site was first developed in 1978. Additional residential, commercial and transit infrastructure have been built to the north, east, south and west of the site. The changed character has formed from an increased population, and frequency of visibility from this site. Sixth Avenue now serves as a major artery for connecting the City of Denver and the City of Lakewood. Specifically, at the site itself, the ground has settled, and the existing building is in decay. Evidence of this settling is noticeably

⁴ Denver Zoning Code §12.4.10.8.A.4

Rezone Application (Review Criteria)
Public Storage – 6th & Sheridan

visible. Redevelopment of this site will be cohesive with the nature of the changing character, and will also bring this site into more updated code and City compliance, by eliminating single access units and building a structure that can accommodate soil conductors.

The only way to update this site to current engineering and construction standards is to redevelop the site completely. Currently the site is governed by a dated document and is built using technology not compatible with soil conditions. Public Storage's willingness to invest capital resources into a project of this size shows interest in the overall community's future. The state the property is in, along with the future gains by the community clearly justify the request for rezone.

Proposed Official Map Amendment Consistency with Context

The Map Amendment proposed is consistent with both neighborhood and business context along Sheridan Boulevard. In addition to consistency with the overall area plan, this site adds value to the area thus encouraging further development by other retail and private organizations. It will also provide convenient storage facilities in close proximity to surrounding neighborhoods.

As noted above, the redevelopment of the existing Public Storage will be an asset to the community surrounding the intersection of 6th and Sheridan. The proposed Zone Map Amendment is cohesive with the goals of the City, of surrounding neighborhood organizations and future development needs. Low traffic impact, visual interest, safety and long term maintenance are just a few of the advantages of having Public Storage as a long term landowner. To bring a redevelopment to the neighborhood, and to provide the surrounding community with a much-needed redeveloped facility, a Zone Map Amendment must be considered. Thank you for the time taken to review our application. Should you have any additional questions please do not hesitate to contact us.

Sincerely,
Galloway & Company, Inc.



Zell Cantrell, CDP
Site Development Project Manager, Senior Associate
ZellCantrell@GallowayUS.com
303-770-8884

PROPOSED PLANNED UNIT DEVELOPMENT
NORTHEAST CORNER WEST SIXTH AVE. & SHERIDAN BLVD.

The entire property is proposed to be developed for mini-warehouses. There are approximately 7.037 acres of land under one ownership which shall be developed for self-storage small warehousing from sizes 5' x 10' to 10' x 30'. All buildings will have a height of one-story except midway through the property where there will be an over - under arrangement of two-story buildings due to a 10 foot topographic drop. Also, the manager's office and apartment will be two-stories. There will be no more than a 50% land coverage for all buildings. The remainder of the land will be drives, set backs, and open space.

There is more than ample parking space between buildings for loading and unloading. All roadways between buildings will be paved to a width of 22 feet or more, allowing for both vehicular movement and loading.

A minimum of 20 feet shall be the setback from the public rights-of-way of West Sixth Avenue Freeway Service Road and Sheridan Boulevard. A six foot setback shall be established along the north and east property lines. The entire property shall be enclosed by a 6 foot fence or buildings of masonry construction. If the Fire Department requests emergency gates, they shall be provided. The entire structure shall be lighted at night for security and protection, but controlled so as not to affect adjacent property owners.

Landscaping will be provided on both West Sixth Avenue and Sheridan Boulevard. Trees will be planted to protect the views from the adjacent streets. The landscape development plan calls for Cottonless Cottonwoods, and Russian Olives to be interspered along the two street boundaries. The spacing between these street trees shall be approved by the Department of Parks and Recreation.

Landscaping will also be planted at the main entrance to the development. An area equivalent to 5% of the paved area shall be set aside on the site for landscaping which will include both trees, shrubs and groundcover. Plant materials shall be approved by the landscape architects of the Parks and Recreation Department.

The property was previously an uncontrolled trash land fill project of the City. Due to the poor method of filling, development for residential or high intensity commercial use should not occur at this time. The mini-warehouse construction is the ideal use for the land. It makes complete use of the land while not having the development generate high traffic volume or pedestrian use.

Mini-warehouse development is ideally suited for this site and has a definite advantage to Denver. No large demand of city utilities are needed. The present demand calls for only the most minimum of water and sanitary sewer use. No new tap is required since the single family home presently on the property will be replaced by the manager's quarters. Private utilities, such as gas, are not required in great amounts. Conversely, property tax benefits through construction are great. Storm drainage run-off is designed for a detention pond to drain through pipe on a private easement to Lakewood Gulch, approximately one block to the north.

There is a ten foot sanitary sewer easement running east-west midway through the property. So as to protect the access of this easement, a 20 foot drive will

completely cover this area.

Due to the fact that mini-warehouse facilities are primarily for the private storage of articles of homeowners and apartment renters, plus business in the immediate area, no sound, vibration and emission heat, glare, radiation and fumes will be generated. The development and operation of this activity will be regulated by the 'Limitations on External Effects of Uses,' Section 612.5-2 of the Zoning Code. Traffic generation for ingress and egress will be extremely low - much less than if the present zoning of B-2 and R-4 were built to its full potential.

Signage to identify the property will conform with the standards contained in Section 613.3-3 of the Zoning Code.

The maximum gross floor area ratio will be 0.5:1, or a maximum of 153,265 sq. ft. This is much lower than the zoning presently allows - R-4, which is 4:1 floor area ratio, and B-2, which is 1:1 floor area ratio.

The present comprehensive plan calls for this area to be developed as very high density residential, probably at an R-4 density of up to 60 units per acre. The proposed land use to be suggested this fall for the revised comprehensive plan, calls for mixed uses of commercial and residential, probably

similar to the present zoning on the land. Neither the existing comprehensive plan or its proposed revision is idealistic for the property. In depth studies of the poor land fill and its related problems would have determined that high intensity residential or commercial usage would not be the ideal use for the land. The proposed change in zoning of planned unit development for mini-warehouse construction is the proper use of this site. This use will have the least detrimental affect on the surrounding neighborhood of increased traffic, demand for schools, parks, utilities, and other government services, but would serve a definite need to the surrounding neighborhood.

Approved by the Denver Planning Board on September 7, 1977.



Alan L. Canter, Director of Planning

PUBLIC STORAGE, INC.
 680 SHERIDAN BLVD

NEED 1 BACKLIT CONVEX AWN. COMPLETE
 TO BE 1" B TUBING PAINTED "WHITE"

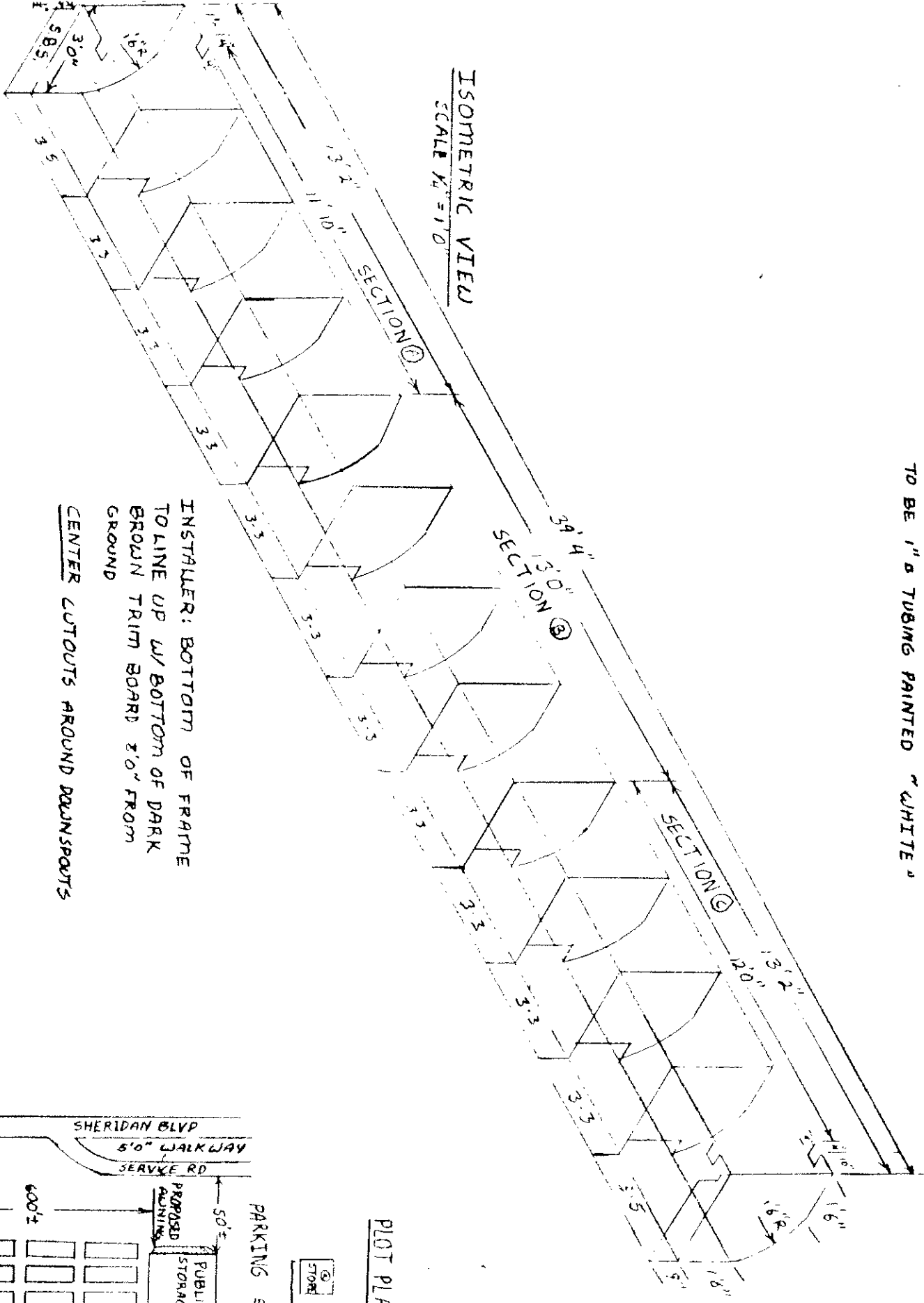

ISOMETRIC VIEW
 SCALE 1/4" = 1'-0"

INSTALLER: BOTTOM OF FRAME
 TO LINE UP W/ BOTTOM OF DARK
 BROWN TRIM BOARD 2'-0" FROM
 GROUND
 CENTER CUTOUTS AROUND DOWNSPOUTS

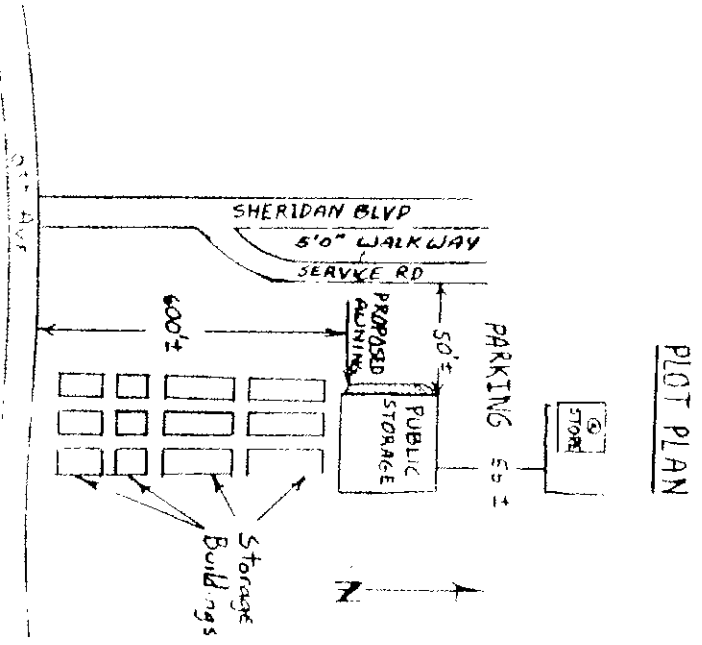

PLOT PLAN