



STANDARD WIRELESS LICENSE AGREEMENT

201734551

PARTIES AND ADDRESSES:

City and County of Denver:

City and County of Denver, Department of Aviation
Denver International Airport
Airport Office Building
8500 Pena Boulevard
Denver, CO 80249-6340

Licensee:

Sprint Spectrum L.P.
6391 Sprint Parkway
Overland , KS 66521-2650

AGREEMENT FOR WIRELESS COMMUNICATIONS SUMMARY PAGE

THIS SUMMARY PAGE WILL BE ATTACHED TO AND MADE A PART OF THAT CERTAIN AGREEMENT FOR WIRELESS COMMUNICATIONS BETWEEN THE CITY AND COUNTY OF DENVER AND THE LICENSEE LISTED BELOW.

LICENSEE NAME	Sprint Spectrum L.P.		
CORPORATE ADDRESS	6391 Sprint Parkway Overland KS 66251-2650		
STATE OF INCORPORATION / IRS EIN	DELAWARE 48 – 1165245		
POINT-OF-CONTACT / TITLE ADDRESS	DANIELE L. HUXTABLE REAL ESTATE MANAGER		
PHONE / EMAIL	O: 720-420-6915 / M: 303-523-0678 DANIELE.HUXTABLE@SPRINT.COM		
PERMITTED USES	INSTALLATION AND OPERATION OF WIRELESS VOICE & DATA TELECOMMUNICATIONS EQUIPMENT FOR PROVIDING SERVICE IN DESCRIBED AREAS OF DENVER INTERNATIONAL AIRPORT IN A MANNER ONLY AS SPECIFICALLY AUTHORIZED HEREIN.		
DENVER CONTRACT NUMBER	TBD		
COMMENCEMENT DATE	JULY 1, 2017		
EXPIRATION DATE	JUNE 30, 2019		
COMPENSATION (Due Quarterly)	UNIT(S)	(x) RATE	
	(A) GROUND RENT	\$0.72 PSF/PY	
	(B) LEASE SPACE RENT	\$36.00 PSF/PY	
	(C) SITE LICENSE FEE	\$61,319.00 PY	
		AND 4% EACH YEAR THEREAFTER	
DISCOUNTS FOR SPECTRUM USE	AVAILABLE SPECTRUM	DISCOUNT	
	61-120 MHz	15%	
	1-60 MHz	25%	
DISCOUNTS FOR MULTIPLE SITES	NUMBER OF SITES	DISCOUNT	
	1-4 Sites	Full Price	
	5-6 Sites	25%	
	7+ Sites	50%	

SITE# & LOCATION	FULL RATE			25% DISCOUNT			50% DISCOUNT			SITE Sq.Ft.	GROUND RENT	LEASE SPACE	GRAND TOTALS
	SITES 1-4	SITES 1-4	SITES 1-4	SITES 5-6	SITES 5-6	SITES 5-6	SITES 7+	SITES 7+	SITES 7+				
	1-60 MHZ	61-120 MHZ	120+ MHZ	1-60 MHZ	61-120 MHZ	120+ MHZ	1-60 MHZ	61-120 MHZ	120+ MHZ				
	\$ 45,989	\$52,121	\$61,319	\$34,492	\$39,091	\$45,989	\$22,995	\$26,061	\$30,660		\$0.72	\$36.00	
#A-1S: CONOCO		\$52,121								2000.00	1440.00		53,561.15
#A-2S: AOB ROOF		\$52,121								200.00	---	7,200.00	59,321.15
#A-3S: CONC-B, 2-SUB E.		\$52,121								171.50	---	6,174.00	58,295.15
#A-4: CDAS/IN-BLDG, CONC. B&C		\$52,121								187.00	---	6,732.00	58,853.15
#A-5: CDAS/PARKING GARAGES					\$39,091					---	---	---	
#A-4: HTC DAS (FUTURE)	---	---	---	---	---	---	---	---	---	---	---	---	---
#A-5: PIKES PEAK (FUTURE)	---	---	---	---	---	---	---	---	---	---	---	---	---
CDAS TUNNELS – NO CHARGE	---	---	---	---	---	---	---	---	---	---	---	---	---
TOTAL	---	208,485	---	---	39,091	---	---	---	---	2558.50	1440.00	20,106.00	\$230,030.60

INSURANCE / SURETY	AMOUNTS	
COMMERCIAL GENERAL LIABILITY	\$ 2,000,000.00	
BUSINESS VEHICLE LIABILITY	\$ 1,000,000.00	
WORKER'S COMPENSATION	COLORADO STATUTORY LIMITS	
PERFORMANCE GUARANTEE AMOUNTS (PERFORMANCE BOND OR ILOC)	\$115,015.30 (6 Months of Annual Rent and Fees adjusted annually effective July 1 st of each year)	
ANNUAL REESTABLISHMENTS Commencing July 01, 2018	UNIT(S) (A) GROUND RENT (B) LEASE SPACE RENT (C) SITE LICENSE FEE	(x) RATE PER PART 120, SECTION 120.09 (DEVELOPED LAND) PER PART 120, SECTION 120.13 (SERVICES) 4% PER YEAR
BUSINESS VEHICLE LIABILITY	\$ 1,000,000.00	
WORKER'S COMPENSATION	COLORADO STATUTORY LIMITS	

TABLE OF CONTENTS

SECTION 1 - DEFINITIONS	1
1.01 Airport/DEN	1
1.02 Airport Airside Operations	1
1.03 CDAS.....	2
1.04 Channel	2
1.05 Cell Site(s)	2
1.06 DEN Operations.....	2
1.07 Emergency.....	2
1.08 FAA.....	2
1.09 First Class Wireless Services.....	2
1.10 Harmful Radio Interference	2
1.11 CEO	2
1.12 Radio Frequency Distribution System	3
1.13 Radio Frequency.....	3
1.14 Radio Interference	3
1.15 Remote Site(s)	3
1.16 Terminal Complex.....	3
1.17 Available Spectrum	3
SECTION 2 - GRANT OF RIGHTS	4
2.01 Cell Site(s)	4
2.02 Use of Cell Site(s)	4
SECTION 3 - TERM	5
3.01 Term of the Agreement.....	5
3.02 Option(s)	5
3.03 Early Termination	5

SECTION 4 - COMPENSATION	6
4.01 License Fees	6
4.02 Site License Fees.....	7
4.03 Additional Costs	7
4.04 Place and Manner of Payments.....	7
SECTION 5 - INSTALLATIONS AND CONSTRUCTION.....	7
5.01 Acquisition, Construction and Installation of the Cell Site(s).....	7
5.02 Installation	8
5.03 Construction Performance Bonds	8
5.04 Site(s) Access.....	9
5.05 Modification of Access Route	9
5.06 Restriction on Alterations	9
SECTION 6 - USE AND OPERATION.....	9
6.01 Compliance with Municipal Rules and Regulations	9
6.02 Compliance with Other Governmental Regulations	9
6.03 No Obstruction to Air Navigation	10
6.04 Right to Enter, Inspect and Make Repairs.....	10
6.05 Care of Area; Repair and Maintenance	10
6.06 Utilities.....	11
6.07 Interruption of Services	11
6.08 Performance Standards	11
SECTION 7 - INSURANCE AND INDEMNITY	12
7.01 Insurance Terms and Conditions	12
7.02 Indemnification.....	14
7.03 Taxes, Licenses, Liens and Fees.....	14
7.04 Surety.....	15
7.05 Books of Account and Auditing.....	15

SECTION 8 – SPECIAL COVENANTS	16
8.01 Assignments by Licensee	16
8.02 Use, Possession or Sale of Alcohol or Drugs.....	16
SECTION 9 – DEFAULT AND REMEDIES	16
9.01 Default.....	16
9.02 Remedies	17
9.03 Administrative Hearing.....	18
9.04 No Waiver.....	18
9.05 Notices.....	18
SECTION 10 - LOSS OF AND LIABILITIES PERTAINING TO CELL SITE(S)	18
10.01 Damage or Destruction and Restoration	18
10.02 Licensee’s Election Not to Restore Damaged Property	19
SECTION 11 - MISCELLANEOUS PROVISIONS.....	19
11.01 Force Majeure	19
11.02 Bond Ordinance	19
11.03 Federal Provisions	19
11.04 Paragraph Headings	20
11.05 Security	20
11.06 Third Parties.....	20
11.07 Colorado Law and Venue.....	21
11.08 Entire Agreement.....	21
11.09 Time is of the Essence	21
11.10 Nondiscrimination	21
11.11 Contract Documents; Order of Precedence	21
11.12 City’s Execution of Agreement	22
11.13 Counterpart of This Agreement	22
Exhibit A – Cell Site Exhibit.....	1

EXHIBIT B - FEE SCHEDULE2

EXHIBIT C - CELL SITE STUDIES.....3

EXHIBIT D - RF SITE / OPERATIONAL STANDARDS.....4

EXHIBIT X - PROVISIONS FOR DESIGN AND CONSTRUCTION OF IMPROVEMENTS.....5

EXHIBIT Z - CITY’S FORM OF INSURANCE CERTIFICATE6

APPENDIX A - E (STANDARD FEDERAL ASSURANCES)7

**STANDARD WIRELESS LICENSE AGREEMENT
201734551**

This STANDARD WIRELESS LICENSE AGREEMENT (“Agreement”) is made and entered as of as of the date stated on City’s Signature Page, by and between **THE CITY AND COUNTY OF DENVER**, a municipal corporation of the State of Colorado, by and for its Department of Aviation (“City”), and **SPRINT SPECTRUM L.P.**, a Delaware limited partnership authorized to do business in the State of Colorado (“Licensee”) (collectively “Parties”).

WHEREAS, City owns and operates the Denver International Airport (“DEN”); and

WHEREAS, Licensee is a wireless communications company licensed by the Federal Communications Commission (“FCC”) to operate in all or some areas in the State of Colorado (“State”); and

WHEREAS, Licensee seeks to construct, install, operate, modify, and maintain radio transmitting and receiving Cell Sites together with other associated electronic equipment and supporting structures in connection with its wireless communications business as needed to construct, expand, and improve its wireless communications service; and

WHEREAS, City desires to co-locate multiple wireless communications companies on antenna support structures at DEN thereby reducing the number of structures required; and

WHEREAS, City intends to make certain properties, assets, and structures at DEN available to wireless communications companies, on a fair and equitable basis, for use as Cell Sites; and

WHEREAS, the Parties acknowledge and agree, this Agreement supersedes and terminates any previous agreements between the Parties for the same Cell Sites listed on the summary page.

NOW THEREFORE, in consideration of the mutual covenants and benefits stated herein, and in further consideration of the obligations, terms and considerations hereinafter set forth, the Parties agree as follows:

SECTION 1 - DEFINITIONS

Words not defined herein shall mean their common usage or technical meaning. As used herein, the following definitions shall apply:

1.01 Airport/DEN

Airport means the Denver International Airport including the Peña Boulevard transportation corridor and the entire land area contained within the Denver Municipal Airport System.

1.02 Airport Airside Operations

Airport Airside Operations means all operations activity on or within the airfield configuration including, but not limited to, taxiways, runways, designated secure airfield areas, navigational aids, and airport structures.

1.03 CDAS

The Concourse Distributed Antenna System (“CDAS”) is a distributed antenna system comprising multiple zones to provide indoor and underground coverage.

1.04 Channel

Channel, also called a circuit, facility, line, link, or path, means a path of communication, either electrical or electromagnetic, between two or more points.

1.05 Cell Site(s)

Cell Site(s) mean any and all facilities, equipment, cable, space, etc. required to effect wireless, (voice, data, video) radio telecommunications. Cell Site(s) may be segregated and/or distinguished by geographic areas or interconnectivity applications via the CDAS. For the purposes of calculating compensation hereunder, Cell Site(s) are the physical area covered, not the physical location of the base station equipment.

1.06 DEN Operations

DEN Operations means the Operations Division of the Department of Aviation.

1.07 Emergency

Emergency means an occurrence or incident at DEN which could possibly result, or has resulted, in property damage, personal injury, or loss of life resulting from any natural cause or cause of human origin including, but not limited to, fire, flood, earthquake, wind, storm, hazardous substance, airplane disaster, oil spill, environmental contamination, epidemic, explosion, civil disturbance, terrorist or hostile military or paramilitary action, or breach of Airport security.

1.08 FAA

FAA means the Federal Aviation Administration, of the U.S. Department of Transportation.

1.09 First Class Wireless Services

Cellular Network voice and data services providing high connection rates (ability to get connected), reliable connection rates (ability to stay connected – low dropped calls and data packet delay or packet loss) and exceptional median upload and download speeds for data for all public areas and back office spaces, in accordance with industry standards. This includes a superior customer experience for patrons and employees at DEN in all areas of DEN both indoors and outdoors across the entire DEN campus.

1.10 Harmful Radio Interference

Harmful Radio Interference is radio interference causing circuit outages and/or message losses. Harmful Radio Interference seriously degrades the performance of the communications, radar, or other electronic systems at DEN.

1.11 CEO

CEO means the Chief Executive Officer of the Department of Aviation, and/or any successor in function or title.

1.12 Radio Frequency Distribution System

Radio Frequency Distribution System (“RFDS”) means the communications-cabling infrastructure and electronics for providing wireless communications to underground areas and building interiors not covered by off-air antenna locations.

1.13 Radio Frequency

Radio Frequency (“RF”) means Radio Frequency.

1.14 Radio Interference

Radio Interference is any emission, radiation or induction endangering functioning or degrading, obstructing, or repeatedly interrupting the telecommunications of Airport Operations, Public Safety, FAA, Airlines and/or other tenants and users of RF communications at DEN.

1.15 Remote Site(s)

Remote Site(s) are all Site(s) not identified as being in the Terminal Complex at DEN.

1.16 Terminal Complex

Terminal Complex means all areas (above and below ground) of the Jeppesen Terminal, Concourse A, Concourse B, Concourse C, Airport Office Building, Airport Hotel and Transit Center, and DEN Plaza.

1.17 Available Spectrum

Available Spectrum means the amount of FCC licensed-spectrum in MHz controlled by Licensee in the Denver metropolitan area to include DEN. Available spectrum includes, but is not limited to, spectrum licensed directly from the FCC, as well as leased spectrum. City, in the sole and absolute discretion of the CEO, may choose to discount some licensed spectrum (including unpaired spectrum) from Available Spectrum, if Licensee will not use the spectrum during the term of the Agreement. Changes to Available Spectrum are allowable each contract year, and will not take effect, hereunder, until properly registered with the FCC.

SECTION 2 - GRANT OF RIGHTS

2.01 Cell Site(s)

City hereby grants to Licensee the non-exclusive, revocable, privilege to construct, install, operate, modify, and maintain one or more Cell Sites at DEN, as described in **Exhibit A (Cell Site Exhibit)**, upon the terms and conditions set forth herein, and those within **Exhibit B (Fee Schedule)**.

2.02 Use of Cell Site(s)

Cell Site(s) shall be for the design, installation, maintenance, alteration, repair, replacement, operation, and removal of communications antennas and approved associated RF equipment as necessary. Licensee, subject to the terms and conditions stated herein, may use a portion of the Cell Site(s) for an 800 MHz cellular band and/or 1.9 GHz band or other frequency installations as more fully described in Exhibit A attached herein. The Cell Site plans, as provided for in the complete plans and specifications set forth in **Exhibit C (Cell Site Studies)** generally depict Cell Sites. Licensee may use the Cell Site(s) only for the uses set forth in this Agreement and consistent with **Exhibit D (RF Site / Operational Standards)**.

A. Licensee agrees to share Cell Site(s), as directed by City, with as many wireless communications companies as is technically practical.

B. City retains the right to use and occupy any Cell Site built by Licensee on DEN property, in its sole discretion, for purposes including, but not limited to, DEN's communications systems and/or Denver Public Safety communications systems.

C. Where City occupies a Cell Site installed, operated, and/or maintained by Licensee, City may install equipment or engage a contractor to install equipment as deemed necessary by City.

D. Additionally, City may request Licensee install City's equipment on Cell Sites built by Licensee. Licensee retains the right to refuse to install City's equipment, where City makes such request. Where City requests Licensee install its equipment, Licensee shall promptly, but no later than thirty (30) days after notice, notify City of its intentions. If Licensee elects to install City's equipment, it agrees to do so in a commercially reasonable time. Expenses actually incurred by Licensee for ancillary equipment purchased or installed, or for radio tower work performed by Licensee at City's request in accordance with this Section 2.02, are payable following submission and approval by City of an invoice. Any expenses invoiced must be commercially competitive and documented in reasonable detail.

E. Where City places equipment on any of Licensee's Cell Sites, said equipment will not replace Licensee's equipment, or interfere with Licensee's operations at DEN. City's placement of equipment on any of Licensee's Cell Sites shall not curtail Licensee's ability to exercise an option for renewal under Paragraph 4.02, nor limit its right to terminate under Section 4.03.

F. Licensee shall have the opportunity to review and comment on any plans and/or designs for placement of City's equipment on Licensee's Cell Sites. Licensee must make any comments under this provision within thirty (30) days of receipt of City's plans and/or designs.

SECTION 3 - TERM

3.01 Term of the Agreement

A. The term of this Agreement shall commence on July 1, 2017 ("Commencement Date") and shall terminate on the second (2nd) anniversary thereafter unless otherwise renewed or terminated by City and Licensee ("Expiration Date") (collectively "Term").

B. The Term for any Cell Sites added by Licensee after the Commencement Date ("New Sites") shall run co-terminus with Cell Sites in existence on the Commencement Date.

C. Any use and/or occupancy by Licensee of Cell Sites with the prior written consent of City after the Expiration Date shall be on a month-to-month basis, with all provisions of this Agreement, including compensation, fees charges, insurance policies, Surety, and Guarantees remaining in place until such time City gives notice to Licensee to surrender the Cell Sites. The Parties must provide notice of/to surrender the Cell Sites in writing not less than thirty (30) days prior to the anticipated surrender date. Licensee shall continue to pay license fees at the agreed upon rate (plus applicable cost-of-living increase) until such time a new agreement is fully executed or proper notice of surrender. If the Parties execute a new agreement during this period, any change in license fee rates shall apply retroactively to the commencement date of the new agreement.

3.02 Option(s)

The Parties shall have an option to extend the Term of this Agreement for one (1) one-year term, subject to City's right to modify or change the License fees as provided for in Section 5.01 below. Additionally, any extension of the Term is subject to the condition precedent Licensee has not caused any uncured Harmful Radio Interference during the term of this Agreement. To exercise its option hereunder, Licensee shall give City written notice of its intent to extend the Term no later than ninety (90) days prior to the second (2nd) anniversary of the Commencement Date. City shall respond to Licensee's extension request, in writing, no later than ninety (90) days after receipt of Licensee's written notice.

3.03 Early Termination

Licensee has the right to terminate this Agreement without cause upon giving six months prior written notice to City. However, nothing herein shall give Licensee the right to operate hereunder beyond the time when Licensee's design, installation, maintenance, alteration, repair, replacement, operation, and removal of Cell Sites no longer comply with the specifications set forth in this Agreement or when Licensee has breached this Agreement in any other manner, as determined in the sole discretion of the CEO.

3.04 Termination of Use and Relocation

City may demand Licensee cease use of any specific Cell Site for reasons of operational necessity, security, or emergency, as determined in the sole discretion of the CEO. Where City makes such request, City shall provide Licensee written notice, as soon as practicable, it must cease use of the specific Cell Site. City will make commercially reasonable efforts to find and make available to Licensee another suitable Cell Site for Licensee's use. Licensee solely shall bear the cost of relocation under this provision.

3.05 Responsibilities upon Termination

A. Surrender of Cell Site(s). Upon the Expiration Date, Licensee covenants and agrees to surrender possession of the Cell Site(s) to City in the same condition as when first occupied, except ordinary wear and tear.

B. Removal. Licensee shall remove, at its sole cost and expense, within one hundred twenty (120) days of the Expiration Date, all of Licensee's installed equipment and fixtures at the Cell Site(s). If such removal shall injure or damage the Cell Site(s), Licensee agrees, at its sole cost and expense, to repair such injury or damage in a good and skillful manner and to put the Cell Site(s) in the same condition as if the equipment and fixtures had not been installed, except ordinary wear and tear. If Licensee fails to remove its equipment and fixtures within one hundred twenty (120) days of the Expiration Date, City, at its option, may remove, keep, or retain any of the equipment and fixtures at the Cell Site(s) or dispose of the same and retain any proceeds therefrom. City is further entitled to recover any costs in removing the equipment or fixtures and in restoring the Cell Site(s) with an allowance in favor of Licensee for ordinary wear and tear. For purposes of this Agreement, the Parties shall treat any of Licensee's fixtures as if they were Licensee's personal property.

SECTION 4 - COMPENSATION

4.01 License Fees

A. Licensee agrees to pay and City agrees to accept a License Fee, comprised of the total sum for Ground Fees, Space Fees, Electric Utility Charges and Site License Fees for all Cell Sites inclusive and set forth on Summary Page incorporated herein by reference, beginning on the Commencement Date and/or the date a Notice to Proceed ("NTP") is issued for the Cell Site, and thereafter on the first day of each calendar month during the Term. During the Term, City may modify Ground Fees and Space Fees annually through the Denver Municipal Airport Systems Rules and Regulations ("DEN Rules"), Rule 120.09 (developed land fee) and 120.13 (service concession fee), subject to City's right to reestablish or modify rates fees and charges more frequently, in accordance with any City Bond Ordinances applicable to DEN. Other than an annual cost-of-living increases of four percent (4%), the Site License Fee, as described in Section 4.02, may be modified only upon each term extension(s) as described in Section 4.02, and may include a reasonable increase or decrease consistent with market conditions. City will give Licensee reestablished Site License Fees not later than ninety (90) days prior to the second (2nd) anniversary of the Commencement Date. Upon changes to the License Fee, City will prepare an updated Summary Page for execution by Licensee to memorialize its acceptance of any reestablished License Fees. Licensee's failure to execute the Summary Page, within ninety (90) days of receipt, shall terminate Licensee's option to extend the Term of this Agreement.

B. City agrees to assess fees and charges reasonably related to the cost of providing the facilities, infrastructure, and utilities used by Licensee on DEN. Licensee acknowledges the rate base for rentals, fees and charges at DEN must generate gross revenues to the City, which together with Other Available Funds (as defined in the City's General Bond Ordinance) must be sufficient to satisfy the Rate Maintenance Covenant of the City's General Bond Ordinance. Licensee agrees such rentals, rates, fees, and charges are reasonably related to the cost of providing the facilities, infrastructure, and utilities used by Licensee on DEN.

C. For the purposes of determining the appropriate License Fees hereunder, notwithstanding any approved merger, acquisition or other aggregation of two or more Licensees, or transfer interest in a Cell Site from one Licensee to another, the Parties agree each Cell Site is subject to individual License Fees.

4.02 Site License Fees

Licensee acknowledges and understands Cell Site License Fees established hereunder are standard for all carriers. City, in good faith, utilizing reasonable airport market equivalencies and/or other acceptable economic factors has established these standard Cell Site License Fees. Licensee acknowledges and understands City applies these standard Cell Site License Fees to all wireless communications companies at DEN without discrimination. However, if Licensee develops technology so different and/or unique its value at DEN cannot be logically or practically measured using the charging methodology stated herein, City shall have the right to apply a new rate making derivative(s) hereunder. Any new rate making derivatives shall be reasonably calculated by City and agreed upon between the Parties. After agreement by the Parties, any new rate making derivatives will be added to an amended Exhibit B and Summary Page, confirmed by Letter executed by the CEO without need for formal amendment to this Agreement. New rate making derivatives will be added to each Licensee using the same technology without discrimination.

4.03 Additional Costs

Licensee shall pay, in proportion to the share of RF interference caused by its operations, for all costs associated with the Cell Site interference studies, field tests and activities of City directly related to the resolution of RF interference to City or Licensee radio signals as determined to be caused by Licensee's operations.

4.04 Place and Manner of Payments

A. Licensee shall deliver payments required by this Agreement through the Automated Clearing House ("ACH") or Electronic Fund Transfer ("EFT") systems. Instructions for payments are located at <https://www.denvergov.org/payments/dia/vendors>. During the Term, City may change the designated place of payment at any time by City upon ten (10) days' written notice to Licensee. Licensee assumes all risk of loss of payments. Licensee must make all payments due under this Agreement in lawful money of the United States of America. City may accept payment without prejudice to its right to recover the balance of said amount due and to pursue any other remedies in this Agreement or otherwise.

B. Without waiving any other right or action available to City, in the event Licensee is delinquent in the payment of the License Fee hereunder for a period of five (5) business days after the payment is due, City reserves the right to charge Licensee interest thereon, from the date such License Fee became due to the date of payment, at the Federal Reserve Bank of New York prime rate in effect on the date the License Fee became due plus four percent (FRBNY prime +4%) or 18% per annum, whichever is greater, to the maximum extent permitted by law.

SECTION 5 - INSTALLATIONS AND CONSTRUCTION

5.01 Acquisition, Construction and Installation of the Cell Site(s)

Licensee shall, at its own cost and expense, commence construction and installation of Cell Site(s) within ten (10) days of the later to occur of: (i) the date stated in the Notice to Proceed; or (ii) receipt of all required permits. Licensee agrees all construction work performed hereunder, including all workmanship and materials shall be of First Class quality. Licensee must perform all construction and installation hereunder in accordance with the requirements of this Agreement, **Exhibit X (Provisions for Design and Construction of Improvements)**, and all applicable laws, regulations, ordinances,

codes and permits including, but not limited to, worker's compensation requirements, City's prevailing wage ordinance, Denver Revised Municipal Code ("D.R.M.C."), §20-76, City's MBE/WBE participation requirements, D.R.M.C. Articles III and VII, and the Americans with Disabilities Act, 42 U.S.C. 12,000 et seq., and its regulations.

5.02 Installation

Licensee shall not install any Cell Site(s) without the prior review and written approval by the CEO and/or their designee of the plans and specifications for such Cell Site(s). Licensee's plans and specifications for Cell Site(s) shall include complete specifications of Effective Radiated Power ("ERP"), operating frequencies, antenna number, orientation, make and model and radiation patterns (both horizontal and vertical plane patterns), antenna height and location (see Exhibit C). City will review and provide written response to Licensee as soon as commercially practicable, but no later than thirty (30) business days from submission of the plans and specifications. Approval by City of any plans and specifications refers to the conformity of such plans and specifications to DEN standards. Approval of any plans and specifications by City does not constitute its representation or warranty as to their conformity with applicable laws, statutes, codes, or permits and responsibility therefore at all times remains with Licensee.

A. Licensee agrees to install all communications equipment, systems, channels, and frequencies consistent with **Exhibits C** and **D** attached hereto. City may require Licensee to continue to resubmit designs and layout proposals until they meet DEN's standards. City may withhold its approval upon any reasonable basis, documented in writing and provided to Licensee. Licensee covenants not to make any substantial changes or alterations to approved plans or specifications without resubmittal to City.

B. Licensee shall submit four (4) copies of the full and complete plans and specifications for all construction and installation of Cell Site(s), including a schedule of the time required to complete the project to the DEN's Telecommunications Office. After final approval by City, City shall return to Licensee one approved copy for its records and shall retain one approved copy as an official record thereof.

C. Upon completion of the Site(s), Licensee shall furnish to City Auditor evidence of payment, contractor's affidavits, and full and final waivers of all liens for labor, services, or materials. Licensee shall include in Licensee's agreement with its contractors provisions whereby such contractor shall defend and hold harmless City from all costs, liens, damages and expenses related to such work.

5.03 Construction Performance Bonds

Prior to commencement of construction, installation, or modification of at any Cell Site(s), Licensee and/or its contractors shall furnish to City a surety instrument (corporate surety bonds or such other acceptable as approved in writing by City). The surety company must be licensed to transact business in Colorado and have appropriate capital to secure Licensee's construction obligations. The surety instrument must list Licensee and its contractor(s) as principals, and must secure a sum not less than 100% of the total cost of the contract(s) for the construction of the Cell Site. Such surety instrument shall guarantee prompt and faithful performance of all contracts for Cell Sites, prompt payment by Licensee to its contractors, and prompt payment by Licensee's contractors to all persons or subcontractors of all tiers supplying labor, materials, supplies, rental machinery, tools, and equipment used directly or indirectly by such contractor. The surety instrument shall protect and indemnify City from any liability, losses, or damages arising from Licensee's construction of Cell Sites.

5.04 Site(s) Access

Subject to the rules, regulations, and/or standards adopted and promulgated by City or the CEO regarding DEN and the Denver Municipal Airport System the Airport, incorporated herein by reference, Licensee has the right of access, ingress to and egress from the Cell Site(s) for Licensee's employees, agents, suppliers of materials and furnishers of service, so long as such personnel have visible Airport Identification Badges issued by Airport Security, and its equipment, vehicles, machinery and other property necessary for the repair, maintenance, removal, installation or operation of the Cell Site(s), meet TSA regulatory standards and are approved by Airport Security. Licensee shall be responsible for providing, if necessary maintaining, its access routes and snow removal.

5.05 Modification of Access Route

City may, from time to time, temporarily or permanently close, consent to, or request the closing of any roadway, taxiway/apron, other right-of-way, access path for ingress and egress, or any other area at the Airport. City agrees in such event it will make commercially reasonable efforts to substitute an alternative means of access for Licensee to its Cell Sites. Licensee hereby releases and discharges City from all claims, demands, or causes of action, which Licensee may have against City, arising out of the closing of any roadway, right-of-way, taxiway/apron, access path for ingress and egress, or any other area at the Airport. Should City close all access to Licensee's Cell Site(s) for any reason, City agrees to make all commercially reasonable efforts to grant Licensee access to its Cell Sites as soon as practicable, the case of any emergency materially affecting Licensee's operations.

5.06 Restriction on Alterations

Licensee may at its own cost and expense, subject to prior written consent of the CEO, install in or on the Cell Site(s), any fixture, improvement, make alterations, or construct additions thereto, germane to the use herein granted so long as any such changes do not impair the capital value or structural integrity or the Cell Site(s). Any such changes made without prior written approval shall be removed or modified, at the option of City and at Licensee's sole cost and expense, as soon as commercially practicable after Licensee receives notice from City. Should Licensee fail to comply after notice, City remove or modify the change to the Cell Site(s) and Licensee shall pay the cost thereof to City plus and additional fifteen percent (15%) administrative charge.

SECTION 6 - USE AND OPERATION

6.01 Compliance with Municipal Rules and Regulations

Licensee, its officers, employees, and agents shall comply with the rules, regulations and standards governing the use or modification of Cell Site(s) (*Exhibit D*), the Denver Municipal Airports System's rules and regulations, as amended, and any other rules or regulations that may be adopted and promulgated by City or the CEO for management, operation and control of DEN. However, City shall not interpret such rules and regulations inconsistent with the privileges granted to Licensee herein. No privileges granted herein shall restrict the police power of City.

6.02 Compliance with Other Governmental Regulations

The Parties shall, at all times, faithfully obey and comply with all existing and future laws, rules and regulations adopted and promulgated by Federal, State, local or other governmental bodies applicable to or affecting Licensee and the exercise of privileges granted herein.

6.03 No Obstruction to Air Navigation

Licensee covenants no physical obstruction to air navigation, as determined by application of the FAA's for physical obstructions to air navigation, will be permitted on or within the Cell Site(s) during construction or operation of Cell Site(s) at DEN. Licensee covenants it shall remove any such obstruction placed on or within the Cell Site(s) at its own sole cost and expense.

6.04 Right to Enter, Inspect and Make Repairs

City and its authorized officers, employees, agents, contractors, subcontractors and other representatives shall have the right, to enter the Cell Site(s) for the following purposes:

A. Absent an emergency and upon advance written notice to Licensee, to inspect the premises at reasonable intervals during regular business hours to determine whether Licensee has complied and is complying with the terms and conditions of this Agreement with respect to such Cell Site(s). Licensee is entitled to have its representative present during an inspection conducted pursuant to this paragraph, 7.04 A; and

B. Absent an emergency and upon advance written notice to Licensee, to perform maintenance and make repairs and replacements in any case where Licensee is obligated but has failed to do so after City has given Licensee reasonable notice of its delinquency; and

C. In the exercise of City's police power, no entry onto the Cell Sites by or on behalf of City shall cause or constitute a termination of the Agreement or be deemed to constitute Radio Interference with the possession thereof by Licensee. City and its officers, employees, agents, contractors, subcontractors and other representatives may inspect at any time without notice and without the presence of Licensee's representative in the case of an emergency. City shall avoid contact with Licensee's equipment and shall not interfere with Licensee's operations, except to the extent necessary pursuant to paragraph 6.04 B., C, or as otherwise required by the emergency. Should entry take place due to an emergency, City shall immediately notify Licensee of such entry.

6.05 Care of Area; Repair and Maintenance

Licensee agrees it will keep the Cell Site(s) and installed equipment in a first class condition at all times. During the Term, Licensee shall maintain, care for, and make any necessary replacement of Cell Site(s), in a first class condition, at its sole cost and expense. Licensee covenants and agrees the following actions constitute keeping the Cell Site(s) in a first class condition:

A. Licensee shall keep the Cell Site(s) in good order and condition and will make all necessary and appropriate repairs, replacements and renewals thereof; and

B. Licensee shall not permit rubbish, debris, waste materials or anything unsightly or detrimental to health, or likely to create a fire hazard, or conducive to deterioration, to remain on any part of the Cell Site(s) or to be disposed of improperly; and

C. Licensee shall maintain the Cell Site(s) in accordance with all applicable codes, technical standards of City and manufacturer's specifications; and

D. Licensee shall store tools, test equipment and work materials only in areas approved by City, and

E. Licensee shall restore any areas of the Cell Site(s) modified by Licensee to their original condition upon termination, reasonable wear and tear excepted.

6.06 Utilities

A. Licensee understands and acknowledges City will not provide electrical power to or within Remote Site(s). Licensee agrees City shall not be liable or responsible for the quality or quantity of the wiring system or other utilities. Licensee shall be responsible for the costs of such utilities.

B. Licensee shall be responsible for and provide independent ventilation, heating, and air conditioning systems for the Cell Site(s), where applicable.

C. Licensee shall provide Sentinel metering for all Terminal Complex Site(s). City shall invoice licensee monthly for the electrical usage on a straight cost-recovery basis.

6.07 Interruption of Services

Licensee agrees City shall not be liable for failure to supply any utility services. City reserves the right to discontinue utility services, as necessary, because of accident, unavailability of employees, repairs, alterations or improvements or whenever because of strikes, lockouts, riots, acts of God or any other happenings beyond the control of City. City shall not be liable for damages to persons or property for such discontinuance, nor shall such discontinuance in any way be construed as cause for abatement of fees or operate to release Licensee from any of its obligations hereunder.

6.08 Performance Standards

A. Performance Requirement. It is City's intention wireless communication services at DEN be conducted in a manner so as to meet the highest expectations and needs of DEN patrons and employees to reflect positively upon Licensee and City. Licensee shall equip, organize, and efficiently manage its operations at DEN to provide First Class Wireless Communication Services to patrons of DEN.

B. Annual Review. No later than ninety (90) days after the end of the first full Contract Year, and at the end of each Contract Year thereafter, City will review and evaluate Licensee's performance at DEN through the data and information published by independent sources, internal sources, and/or data provided by Licensee. During the course of the review, City may determine, in its sole discretion, the sufficiency of Licensee's performance at DEN including but not limited to the following factors:

1. Connectivity – Licensee cellular coverage and signal quality within both public spaces and secured, sterile, and all other areas of DEN. This includes improvements made by Licensee over the Contract Year annual period at their own initiative or for areas where DEN has reported areas of poor performance and has asked for improvements.
2. Download and Upload Speeds – Licensee's ability to maintain median cellular download and upload speeds of 40Mbps and 20Mbps respectively during peak travel times.

3. Independent Rankings – Licensee’s contribution to DEN’s goal of achieving a ranking within the top 10 airports for cellular service by independent studies.
4. Technological Improvements – Advancements made by Licensee surrounding deployment of new technologies, such as 5G LTE, to enhance overall cellular service at DEN.

C. Performance Incentive. In the event City’s Annual Review establishes Licensee has provided First Class Wireless Communication Services at DEN, City may, in its sole and absolute discretion, establish a discounted rate for some and/or all Licensee Fees paid hereunder during the next Contract Year. In the event City establishes a discounted rate for License Fees paid hereunder, the Parties agree to update the Summary of Contract Provisions to incorporate the discounted rate, to be confirmed by letter executed by the CEO and acknowledged by Licensee, without need for formal amendment to this Agreement.

SECTION 7 - INSURANCE AND INDEMNITY

7.01 Insurance Terms and Conditions

A. Required Insurance. Licensee covenants and agrees to secure, at its own expense and to keep in force at all times hereof, from the Commencement Date, insurance against claims for injury to persons or damage to property arising from or in connection with the performance of obligations under this Agreement by Licensee, its agents, representatives, or employees. The types and amounts of insurance coverage Licensee must procure are specified in the Certificate of Insurance for Aviation, attached hereto as **Exhibit Z** and incorporated herein by reference. Insurance requirements set forth on **Exhibit Z** do not limit in any way the indemnity covenants contained in this Agreement or the amount or scope of liability of Licensee under this Agreement. The amounts listed indicate only the minimum amounts of insurance coverage City is willing to accept to help insure full performance of all terms and conditions of this Agreement. Licensee specifically agrees to comply with each condition, requirement, or specification set forth in **Exhibit Z** during all periods when the required coverage is in effect. Licensee must maintain insurance without any lapse in coverage during the entire Term. Insurance canceled without City’s consent or failure by Licensee to provide evidence of renewal within forty-eight (48) hours after written notice by City is a material breach of this Agreement and, in addition to all other remedies available to City, City may, in its sole discretion, terminate this Agreement. If at any time during the Term the insurance policies procured by Licensee become unsatisfactory to City as to form or substance, or if any of the carriers issuing such policies become unsatisfactory to City, Licensee shall promptly obtain a new and satisfactory replacement policy and give City an updated certificate of insurance that complies with the new insurance requirements of City.

B. Business Interruption Insurance. Licensee shall procure and maintain Business Interruption insurance in such amounts as will reimburse Licensee for direct or indirect loss of earnings attributable to the perils commonly covered by Licensee’s property insurance described in Section 7.01 (A), which shall include losses arising from mechanical failures on or interruption of services to City premises.

C. Cyber Liability Insurance. Licensee shall procure and maintain Cyber Liability coverage in such amounts covering claims involving privacy violations, information theft, damage to, or destruction of electronic information, intentional and/or unintentional release of private information, alteration of electronic information, extortion, and network security.

D. Commercial Crime Insurance. Licensee shall procure and maintain Commercial Crime insurance covering, but not limited to, loss arising from employee theft, employee dishonesty, forgery or alteration, robbery, burglary, embezzlement, disappearance, destruction; money orders and counterfeit currency; depositors forgery; computer fraud, on-premises and in-transit.

E. Mutual Waiver of Subrogation. The Parties waive any right of action they and/or their insurance carriers might have against each other (including their respective employees, officers, commissioners, or agents) or against other business operators at DEN for any Loss, to the extent such Loss is covered by any property insurance policy or policies maintained or required to be maintained pursuant to this Agreement and to the extent such proceeds (which proceeds are free and clear of any interest of third parties) are received by the party claiming the loss. Licensee also waives any right of action it and/or its insurance carrier might have against City (including its respective employees, officers, commissioners, or agents) for any Loss, whether or not such loss is insured. If any of Licensee's applicable insurance policies do not allow the insured to waive the insurer's rights of subrogation prior to a loss, Licensee shall cause it to be endorsed with a waiver of subrogation allowing the waivers of subrogation required by this Section.

F. Certificates Required. Licensee must send all certificates required by this Agreement directly to the City and County of Denver, Department of Aviation, Denver International Airport, Airport Office Building, Room 9870, 8500 Pena Boulevard, Denver, Colorado 80249. Licensee must place City's Contract control number for this Agreement on each certificate of insurance. Licensee must deliver certificates evidencing the existence of the policies, in such form as City may require, prior to the Commencement Date. Upon written request, Licensee agrees to furnish City, at any time thereafter during the Term, the original or a certified copy of said policy or policies.

G. Licensee's Risk. City in no way warrants and/or represents the minimum limits contained herein are sufficient to protect Licensee from liabilities arising out of the performance of the terms and conditions of this Agreement by Licensee, its agents, representatives, or employees. Licensee shall assess its own risks and as it deems appropriate and/or prudent, maintain higher limits and/or broader coverage. Licensee is not relieved of any liability or other obligations assumed or pursuant to this Agreement because of its failure to obtain or maintain insurance in sufficient amounts, duration, or types. In no event shall City be liable for any: (i) business interruption or other consequential damages sustained by Licensee; (ii) damage, theft, or destruction of licensee's property of any kind; or (iii) damage, theft, or destruction of an automobile, whether or not insured.

H. Governmental Immunity. The Parties understand and agree City, its officers, officials, and employees are relying on and do not waive or intend to waive by any provisions of this Agreement, monetary limitations, or any other rights, immunities, and protections provided by the Colorado Governmental Immunity Act, §§ 24-10-101 to 120, C.R.S., or otherwise available to City, its officers, officials, and employees.

I. Self Insurance. Notwithstanding the forgoing, Licensee may, in its sole discretion, self-insure any of the required insurance under the same terms as required by this Agreement. In the event Licensee elects to self-insure its obligation under this Agreement to include City as an additional insured, the following conditions apply: (i) City shall promptly and no later than thirty (30) days after notice thereof provide Licensee with written notice of any claim, demand, lawsuit, or the like for which it seeks coverage pursuant to this Section and provide Licensee with copies of any demands, notices, summonses, or legal papers received in connection with such claim, demand, lawsuit, or the like; (ii) City shall not settle any such claim, demand, lawsuit, or the like without the prior written consent of Licensee; and (iii) City shall cooperate with Licensee in the defense of the claim, demand, lawsuit, or the like.

7.02 Indemnification

To the fullest extent permitted by law, Licensee agrees to protect, reimburse, indemnify, and hold City, its agents, employees, and officers free and harmless from and against any and all liabilities, claims, expenses, losses, costs, fines, and damages (including but not limited to attorney's fees and court costs), and causes of action of every kind and character arising out of, resulting from, incident to, or in connection with Licensee's presence on or use or occupancy of the Cell Site(s) or DEN; Licensee's acts, omissions, negligence, activities, or operations; Licensee's performance, non-performance or purported performance of this Agreement; or any breach by Licensee of the terms of this Agreement, or any such acts, omissions, negligence, activities, or operations of Licensee's officers, authorized officials, employees, agents, subcontractors, invitees, or any other person directly or indirectly employed or utilized by Licensee, resulting in any bodily injury (including death) or any damage to any property, including loss of use, incurred or sustained by any party hereto, any agent or employee of any party hereto, any other person whomsoever, or any governmental agency, regardless of whether or not it is caused in whole or in part by the negligence of a party indemnified hereunder provided that Licensee need not release, indemnify, or hold harmless City, its officers, officials, agents, and employees from damages resulting from the sole negligence of City's officers, officials, agents, and employees.

In addition to the duty to indemnify and hold harmless, Licensee shall have the duty to defend City, its agents, employees, and officers from all liabilities, claims, expenses, losses, costs, fines, and damages (including but not limited to attorney's fees and court costs) and causes of action of every kind and character arising out of Licensee's presence on or use or occupancy of the Cell Site(s) or DEN. The duty to defend under this Section is independent and separate from the duty to indemnify, and the duty to defend exists regardless of any ultimate liability of Licensee, City, and any indemnified party. The duty to defend arises immediately upon written presentation of a claim to Licensee.

Licensee recognizes the broad nature of these indemnification, hold harmless, and duty to defend clauses, and voluntarily makes this covenant and expressly acknowledges the receipt good and valuable consideration provided by City in support of this indemnification in accordance with the laws of the State of Colorado. This Article shall survive the termination of this Agreement. Compliance with insurance requirements under this Agreement shall not relieve Licensee of its liability or obligation to indemnify, hold harmless, and defend City as set forth in this Article.

7.03 Taxes, Licenses, Liens and Fees

Licensee agrees to pay all taxes, excises, license, and permit fees of whatever nature applicable to its operations hereunder and to take out and keep current all municipal, state, or federal licenses required for the conduct of its business at and upon the Cell Site(s). Licensee further agrees not to permit any of said taxes, excises, license, or permit fees to become delinquent. Licensee shall keep the premises free from any liens arising out of any work performed, materials furnished, or obligations incurred by, on behalf, or at the request of Licensee. If a lien is filed against the premises because of work performed, materials furnished or obligations incurred by, on behalf, or at the request of Licensee, Licensee agrees to indemnify City against any expense, cost, or liability incurred by City because of such Lien. Licensee agrees to furnish to the CEO, upon request, duplicate receipts, or other satisfactory evidence showing the prompt payment of Social Security, unemployment insurance and worker's compensation insurance, and all required licenses and taxes. Licensee further agrees to pay all bills, debts, and obligations incurred in connection with its operations hereunder. Licensee shall not permit the same to become delinquent and to suffer no lien, mortgage, judgment, or execution to be filed against the Cell Site(s), or improvements thereon, which will in any way impair the rights of City.

7.04 Surety

A. Licensee shall deliver to the CEO within ninety (90) days of the Commencement Date, and maintain in effect at all times throughout the term until released by City, a valid performance bond or irrevocable letter of credit, approved in writing by City, in an amount equal to one half the current annual License fee as shown on the Summary Page ("Surety"). Such Surety shall be payable to City upon the CEO's sole determination Licensee has breached this Agreement, and shall guarantee to City full and faithful performance of all of the terms and provisions of this Agreement by Licensee, as said Agreement may be amended, supplemented or extended.

B. Notwithstanding any provision herein to the contrary, if at any time during the Term City deems the amount of Surety insufficient to protect City from loss hereunder, Licensee covenants after receiving notice, it will increase the Surety to the amount required by City, provided however, the percentage increase shall not exceed five (5%) of the annual cost of living increase hereunder. In the event City draws on the Surety, within thirty (30) days after notice, Licensee will restore the Surety to its original amount. Licensee understands and agrees failure to maintain or replenish the Surety shall constitute a material breach of this Agreement.

C. The Surety shall be issued by a bank or surety Licensee acceptable to City and authorized to do business in the State of Colorado, and will be in a form and content satisfactory to City. The Surety may be issued for a one (1) year period, provided however, Licensee covenants and agrees evidence of renewal or replacement of the Surety must be submitted annually by to City, without prompt, at least sixty (60) days prior to the expiration date of the instrument. The Surety shall contain language requiring the issuing financial institution to notify City in writing within forty-five (45) days of a determination the Surety is to be terminated and or will not be renewed.

D. Release of Licensee's Surety is subject to satisfactory performance by Licensee of all terms, conditions, and covenants contained herein. Upon termination of this Agreement, the release of Surety will not occur until all fees, charges, and other payments due to City are satisfied evidenced by d the findings of an audit by City in accordance with Section 7.05. In the event of a dispute as to the condition of the Cell Sites, City shall retain only the amount in dispute for remedy. City shall release the Surety without interest within thirty (30) days of meeting the above requirements.

7.05 Books of Account and Auditing

Licensee shall keep or make available upon request true and complete records and accounts of all payment obligations, payments made, site capacity and other such documents as are relevant to Licensee's compliance with the terms of this License and related Agreements.

City's Auditor, CEO, or their respective authorized representatives shall have the right at any time to inspect or audit any or all of the records Licensee is required by this section to keep and maintain.

Licensee, upon written request, shall make all documents required by this provision available for examination within the Denver metropolitan area; or shall pay to City in full, in advance, travel and related expenses of a City representative to travel to any location outside the Denver area for such examination. Following travel, expenses shall be reconciled, and any difference between the advance payment and the actual expenses shall be refunded to Licensee. Such documents shall be available to City's representative within fourteen (14) calendar days of the date of a written request. The Parties agree any delay in furnishing such records to City will cause damages to City. The Parties agree the cost and extent of such damages are difficult to forecast at this point, therefore the Parties agree, in

the event Licensee is delayed in furnishing requested records it will pay City Three Hundred and Fifty Dollars (\$350.00) per day for each record unavailable beyond the date established in City's notice.

If City determines any deficiency after an audit, Licensee shall pay the amount of the deficiency plus interest in accordance with Section 4.04. If the amount of underpayment by Licensee for exceeds 1% of the amount due for that year, Licensee shall pay to City the cost of the audit, in addition to the deficiency and interest. City's right to perform such an audit shall expire on the third anniversary of the Expiration Date.

Licensee agrees City's Auditor, CEO, or authorized representatives, may inspect any tax data provided to the Department of Revenue as required by Denver's Revised Municipal Code, Chapter 53, Taxation and Miscellaneous Revenue and any related audit reports and data generated by the Department of Revenue. Licensee waives any claim of confidentiality it may have in connection therewith for the limited purpose of City's audit hereunder. Such records may include taxpayer's returns or reports, accompanying schedules and data, and associated audit data.

SECTION 8 – SPECIAL COVENANTS

8.01 Assignments by Licensee

Licensee shall not assign, sublet, or otherwise transfer its interest in this Agreement, in whole or in part, or any privilege(s) or interest(s) granted to hereunder without the prior written consent of City. However, Licensee may assign this Agreement or a portion thereof, to any business entity, which is a parent, subsidiary, affiliate, or to any party that acquires substantially all of the assets of Licensee, upon notice to City.

8.02 Use, Possession or Sale of Alcohol or Drugs

Licensee and its officers, agents and employees shall cooperate and comply with the provisions of City's Executive Order No. 94 and any amendments thereto, or any successor executive order concerning the use, possession or sale of alcohol or drugs.

SECTION 9 – DEFAULT AND REMEDIES

9.01 Default

Licensee shall be in substantial default under this Agreement if Licensee:

- A. Fails to timely pay when due to City the fees or any other payments required hereunder; or
- B. Becomes insolvent, or takes the benefit of any present or future insolvency or bankruptcy statute, or makes a general assignment for the benefit of creditors, or consents to the appointment of a receiver, trustee or liquidator of any or substantially all of its property; or
- C. Transfers its interest under this Agreement, without the prior written approval of City under Section 8.01; by reason of death; operation of law; assignment; sublease or otherwise, to any other person, entity or corporation; or
- D. Fails to timely submit plans and specifications, bonds and other preconstruction submittals or fails to occupy and use the Cell Site(s) after installation is completed; or

E. Abandons, deserts, or vacates the Cell Site(s) space; or

F. Suffers any material men's or mechanic's lien or attachment to be filed against the Site(s), the Airport or City's property because of any act or omission of Licensee, and such lien or attachment is not discharged or contested by Licensee in good faith by proper legal proceedings within twenty (20) days after receipt of notice thereof by Licensee; or

G. Fails to keep, perform or observe any promise or covenant set forth in this Agreement and such failure continues for a period of more than thirty (30) days after delivery of a written notice of such breach or default, except where a shorter period is specified herein, or where fulfillment of its obligation requires activity over a longer period of time, so long as Licensee commences in good faith whatever is required to correct its breach or default within ten (10) days; or

H. Gives its permission to any person to use for any illegal purpose any portion of the DEN made available to Licensee for its use under this Agreement.

I. Licensee's failure to maintain any type of insurance or level of insurance coverage required hereunder (and in the event Licensee has failed to remedy such failure within ten (10) days after notice thereof from City, City may effect such coverage and recover the cost thereof immediately from the Surety or from Licensee).

City reserves the right, in its sole discretion, to treat each Cell Site individually for the purpose of declaring defaults and exercising remedies under this Agreement.

9.02 Remedies

If Licensee defaults in any of the covenants, terms and conditions herein, City may exercise any one or more of the following remedies:

A. City may elect to allow this Agreement to continue in full force and effect and to enforce all of City's rights and remedies hereunder, including without limitation the right to collect compensation as it becomes due together with interest; and/or

B. City may cancel and terminate this Agreement and repossess the Cell Site(s), with or without process of law, and without liability for so doing, upon giving thirty (30) days written notice to Licensee of its intention to terminate, at the end of which all privileges hereunder of Licensee shall terminate, unless the default has been cured within thirty (30) days or receipt of such notice. Notwithstanding the foregoing, Licensee is allowed to cure only two notices of default hereunder within the time specified in this Section. The third notice of default shall be final and at the option of City (1) shall cancel and terminate all of the privileges hereunder of Licensee, and City may immediately reenter the Cell Site(s) and remove therefrom all property of Licensee and store the same at the expense of Licensee, or (2) elect to proceed under paragraph C below; and/or

C. Where City elects to terminate, Licensee shall be liable to City for all amounts owing at the time of termination, including but not limited to compensation due plus interest thereon together with any other amount to fully compensate City for all loss of compensation, damages, and costs, including attorney's fees, caused by Licensee's failure to perform its obligations hereunder, or which in the ordinary course would likely result therefrom.

D. The remedies provided in this Agreement shall be cumulative and shall in no way affect any other remedy available to City at law or in equity.

9.03 Administrative Hearing

All Licensee's disputes of decisions, determinations, or other actions by City arising out of this Agreement shall be resolved by administrative hearing following the procedures outlined in Denver Revised Municipal Code Section 5-17, as amended. The Parties understand, acknowledge, and agree all jurisdictional prerequisites under Section 5-17 shall apply in full force to disputes hereunder.

9.04 No Waiver

No failure of City to insist upon the strict performance of a term, promise, or covenant contained in this Agreement shall be deemed or construed as a waiver by City of any succeeding or other breach.

9.05 Notices

All notices or communication, pursuant hereto, shall be deemed delivered upon receipt by hand delivery, or three (3) days after depositing such notice or communication in a postal receptacle, return receipt requested, or one (1) day after depositing such notice or communication with a reputable overnight courier service, and addressed as follows:

By Licensee to: Chief Executive Officer
Denver International Airport
Airport Office Building, 9th Floor
8500 Peña Boulevard
Denver, CO 80249

By City to: Sprint Property Services
Mailstop KSOPHT0101-Z2650
6391 Sprint Parkway
Overland Park, KS 66251-2650

CC: Sprint Law Department
Attn.: Real Estate Attorney
Mailstop KSOPHT0101-Z2020
6391 Sprint Parkway
Overland Park, KS 66251-2650

or to such other address or parties within the State of Colorado as either party may designate in notice to the other Party delivered in accordance with the provisions of this Section.

SECTION 10 - LOSS OF AND LIABILITIES PERTAINING TO CELL SITE(S)

10.01 Damage or Destruction and Restoration

In case of damage or loss of all or any portion of the Cell Site(s), Licensee shall give prompt notice thereof to City; and, except as otherwise provided herein including, without limitation, Section 10.02, Licensee shall promptly commence and complete with due diligence, the restoration of the Cell Site(s) as nearly as reasonably practicable to the value and condition thereof immediately prior to such damage or destruction. In the case of damage or destruction, Licensee shall have the right to install temporary facilities. Said temporary facilities' location will be subject to approval by City. The temporary facilities location must ensure minimal disruption to Licensee's system until permanent repair or replacement are completed. City will cooperate with Licensee to designate the temporary facility location and if possible, designate the temporary facility within forty-eight (48) hours after receiving notice from Licensee of damage or destruction of Licensee's Cell Site(s). In the event of such damage or destruction, Licensee shall be entitled to use or receive reimbursement from the

proceeds of all property insurance policy or policies for the Cell Site(s) and shall be obligated to provide any additional moneys necessary for such restoration.

10.02 Licensee's Election Not to Restore Damaged Property

In case of the damage or destruction of all or any part of the Cell Site(s), Licensee, with ninety (90) days notice thereafter, may elect not to restore or replace the Cell Site(s). In such event, this Agreement shall be automatically terminated, for the affected Cell Site(s), ninety (90) days after notice from Licensee.

SECTION 11 - MISCELLANEOUS PROVISIONS

11.01 Force Majeure

The Parties hereto shall not be liable to the other for any failure, delay or interruption in the performance of any of the terms, covenants or conditions of this Agreement due to causes beyond the control of that party, including without limitation, strikes, boycotts, labor disputes, embargoes, shortages of materials, acts of God, acts of the public enemy, acts of superior governmental authority, weather conditions, floods, riots, rebellion, sabotage or any other circumstance for which such party is not responsible or which is not in its power to control, but in no event shall this paragraph be construed so as to allow Licensee to reduce or abate its obligation to pay the fees herein.

11.02 Bond Ordinance

This Agreement and the privileges granted or conveyed hereby are in all respects subject and subordinate to all City Bond Ordinances applicable to the Denver Municipal Airport System and any other bond ordinances that may amend, supplement, or replace such Bond Ordinances.

11.03 Federal Provisions

This Agreement is subject and subordinate to the terms, reservations, restrictions and conditions of any existing or future Agreements between City and the United States, the execution of which has been or may be required as a condition precedent to the transfer of federal rights or property to City for airport purposes, and the expenditure of federal funds for the extension, expansion or development of City's airport system. The provisions of the attached Appendixes A – E are incorporated herein by reference.

A. General Civil Rights. Licensee agrees to comply with pertinent statutes, Executive Orders and such rules as are promulgated to ensure that no person shall, on the grounds of race, creed, color, national origin, sex, age, or disability be excluded from participating in any activity conducted with or benefiting from Federal Assistance. This provision binds Licensee and sub-tier contractors from the bid solicitation period through the completion of the contract. This provision is in addition to that required of Title VI of the Civil Rights Act of 1964.

B. Federal Fair Labor Standards Act. This Agreement incorporates by reference the provisions of 29 C.F.R. Part 201, the Federal Fair Labor Standards Act ("FLSA"), with the same force and effect as if given in full text. The FLSA sets minimum wage, overtime pay, recordkeeping, and child labor standards for full and part time workers. Licensee agrees to incorporate by reference the provisions of FLSA in all contracts and subcontracts resulting from this Agreement. Licensee has full responsibility to monitor compliance to the referenced regulation. Licensee must address any claims or disputes arising from this requirement directly with the U.S. Department of Labor – Wage and Hour Division.

C. Occupational Safety and Health Act. This Agreement incorporates by reference the requirements of 29 C.F.R. Part 1910 with the same force and effect as if given in full text. Licensee must provide a work environment that is free from recognized hazards that may cause death or serious physical harm to the employee. Licensee retains full responsibility to monitor its compliance and any subcontractor's compliance with the applicable requirements of the Occupational Safety and Health Act of 1970 (29 C.F.R. Part 1910). Licensee must address any claims or disputes that pertain to a referenced requirement directly with the U.S. Department of Labor – Occupational Safety and Health Administration.

Licensee covenants it will include the provisions of this section in every subcontract, including procurements of materials and leases of equipment, unless exempt by the Federal Acts, Regulations and directives issued pursuant thereto. Licensee covenants it will take action with respect to any subcontract or procurement as City or the FAA may direct as a means of enforcing such provisions including sanctions for noncompliance. Provided, if Licensee becomes involved in, or is threatened with litigation by a subcontractor, or supplier because of such direction, Licensee may request City to enter into any litigation to protect the interests of City. In addition, Licensee may request the United States to enter into the litigation to protect the interests of the United States.

11.04 Paragraph Headings

The paragraph headings herein are for convenience in reference only and are not intended to define or limit the scope of any provision of this Agreement.

11.05 Security

Licensee, its officers, authorized officials, employees, agents, subcontractors, and those under its control, will comply with safety, operational, or security measures required of Licensee or City by the FAA or TSA. If Licensee, its officers, authorized officials, employees, agents, subcontractors or those under its control fail or refuse to comply with said measures and such non-compliance results in a monetary penalty being assessed against City, then, in addition to any other remedies available to City, Licensee covenants to fully reimburse City any fines or penalties levied against City, and any attorney fees or related costs paid by City as a result of any such violation. This amount must be paid by Licensee within fifteen (15) days from the date of the invoice or written notice.

Licensee understands and acknowledges its ability to remain open and conduct operations under this Agreement is subject to changes in alert status as determined by TSA, which is subject to change without notice. If the security status of DEN changes at any time during the Term of this Agreement, Licensee shall take immediate steps to comply and assist its employees, agents, independent Contractors, invitees, successors, and assigns in complying with security modifications that occur as a result of the changed status. At any time, Licensee may obtain current information from DEN's Security Office regarding DEN's security status in relation to Licensee's operations at the DEN.

11.06 Third Parties

This Agreement does not, and shall not be deemed or construed to, confer upon or grant to any third party or parties any right to claim damages or to bring any suit, action or other proceeding against either Party because of any breach hereof or because of any of the terms, promises, covenants, and conditions herein.

11.07 Colorado Law and Venue

This Agreement and performance hereunder is made in and shall be governed by and construed in accordance with the laws of the State of Colorado. Venue for any action to enforce the provisions of this Agreement shall be in the District Court in and for City and County of Denver.

11.08 Entire Agreement

This Agreement represents the complete understanding between the Parties, and any prior Contracts or representations, whether written or verbal, are hereby superseded. This Agreement may be subsequently amended only by written instrument signed by the Parties hereto, unless provided otherwise within the terms and conditions of this Agreement.

11.09 Time is of the Essence

The Parties agree in the performance of the terms and requirements of this Agreement by either party time is of the essence.

11.10 Nondiscrimination

In connection with the performance of Tasks under this Agreement, **Licensee** agrees not to refuse to hire, discharge, promote, demote, or to discriminate in matters of compensation against any person otherwise qualified solely because of race, creed, color, religion, national origin, gender, age, military status, sexual orientation, gender variance, marital status, and/or physical and mental disability. **Licensee** further agrees to insert the foregoing provision in all subcontracts hereunder.

11.11 Contract Documents; Order of Precedence

This Agreement consists of Sections 1 through 11 that precede the signature page and the following attachments that are incorporated herein and made a part hereof by reference:

- License
- Exhibit A – Cell Site Exhibit
- Exhibit B - Fee Schedule
- Exhibit C - Cell Site Studies
- Exhibit D - RF Site / Operational Standards
- Exhibit X - Provisions for Design and Construction of Improvements
- Exhibit Z - City's Form of Insurance Certificate
- Appendix A – E Standard Federal Assurances

In the event of (i) irreconcilable conflict between a provision of Section 1 through 11 and any of the listed exhibits or attachments, such that it is impossible to give effect to both, or (ii) an irreconcilable conflict between the provisions and any of the exhibits or attachments, the order of precedence to determine which document shall control to resolve such conflict, is as follows, in descending order:

- Appendices A – E
- Sections 1 through 11
- Exhibit B
- Exhibit A
- Exhibit C
- Exhibit D

Exhibit X
Exhibit Z

11.12 City's Execution of Agreement

This Agreement is expressly subject to, and shall not be or become effective or binding on City until, approval by City Council and full execution by all signatories of City and County of Denver.

11.13 Counterpart of This Agreement

This Agreement will be executed in six (6) counterparts through electronic signatures, each of which shall be deemed to be an original of the Agreement. This Agreement may be signed electronically by the Parties in the manner specified by City.

[SIGNATURE PAGE, APPENDIXES, AND EXHIBITS FOLLOW]

Contract Control Number: PLANE-201734551-00

Contractor Name: Sprint Spectrum L.P.

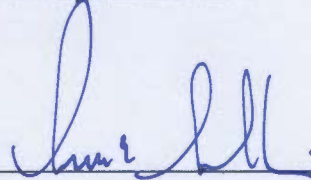
By: 

Name: Dean Siskowski
(please print)

Title: Market Manager
(please print)

ATTEST: [if required]

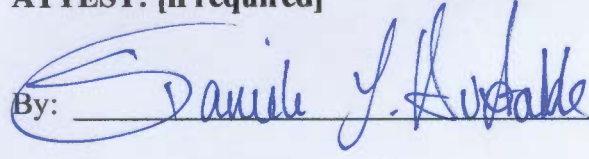
By: 

Name: Daniele Huxtable
(please print)

Title: Real Estate Manager
(please print)



Contract Control Number:

IN WITNESS WHEREOF, the parties have set their hands and affixed their seals at Denver, Colorado as of

SEAL

CITY AND COUNTY OF DENVER

ATTEST:

By _____

APPROVED AS TO FORM:

REGISTERED AND COUNTERSIGNED:

By _____

By _____

By _____



Exhibit A – Cell Site Exhibit

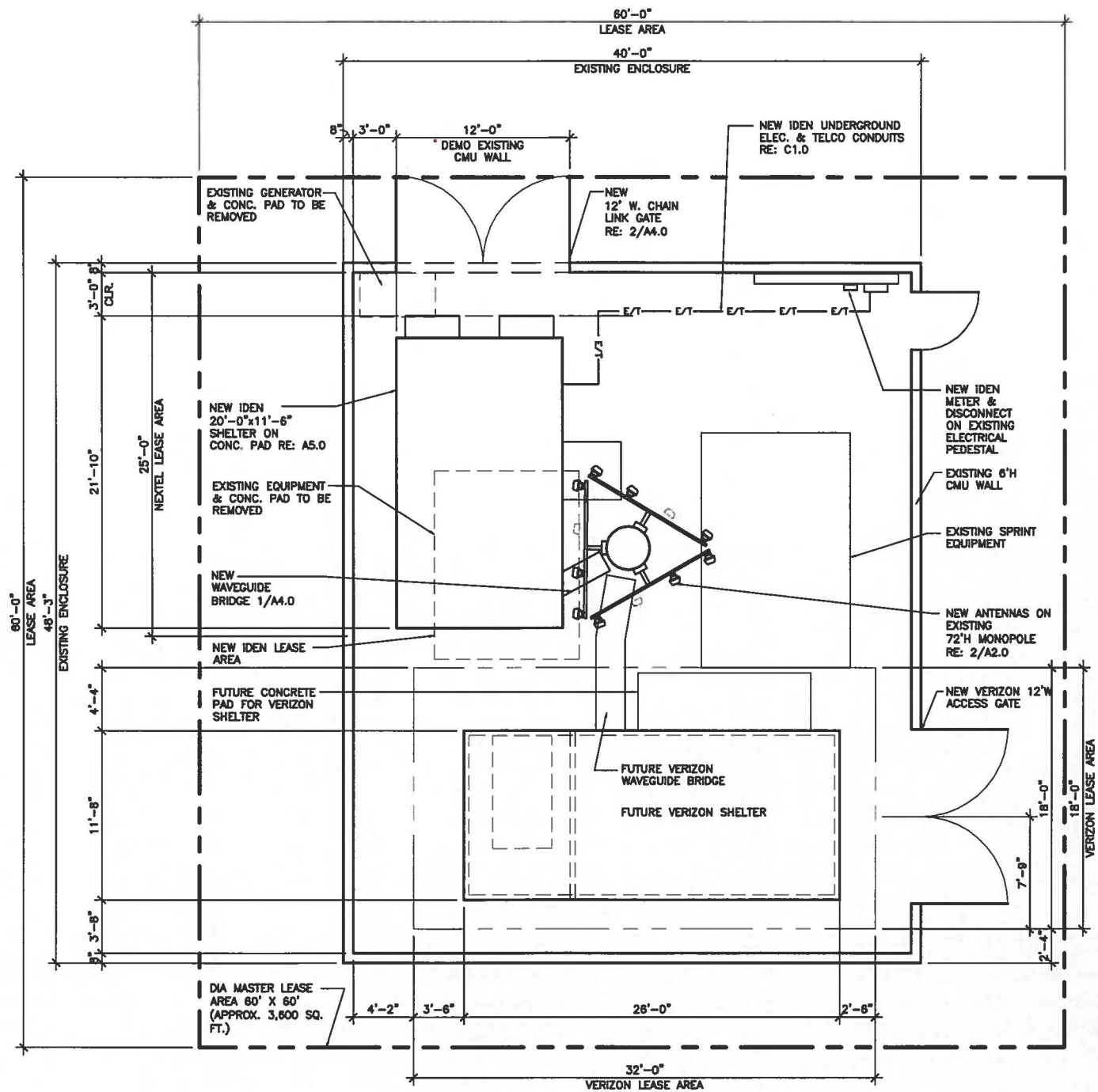

- CONC. WALL (BY CITY)
- STUD/GYPSUM WALL (BY CITY)
- GLASS WALL (BY CITY)
- TENANT LEASE LINE



Joint Use
L14-1-1-W3-S7-2
3600.00 sq. ft.

SCALE 1" = 10.00'



- (H) (■) COLUMNS
- NIC = Not Included
(In Lease or Sq. Ft. Calc.)

NOTE:
This exhibit depicts only approximate dimensions and square footage of leased area based upon planning data and is not intended to show dimensions for construction details.

DEN Property Management

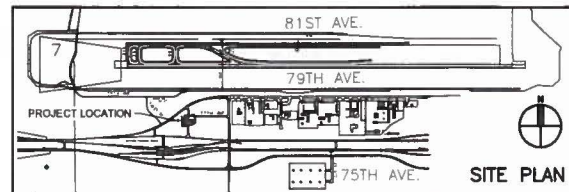

REVISED	DENVER INTERNATIONAL AIRPORT
	Joint Use Conoco Station
CC#:	DATE: 06/01/17

L14-1-1-W3-S7-2

DATE: 05/30/17	cc#:		
DENVER INTERNATIONAL AIRPORT			
EXHIBIT A			
Airport Office Building			
JOINT USE		REVISED	

DEN Property Management

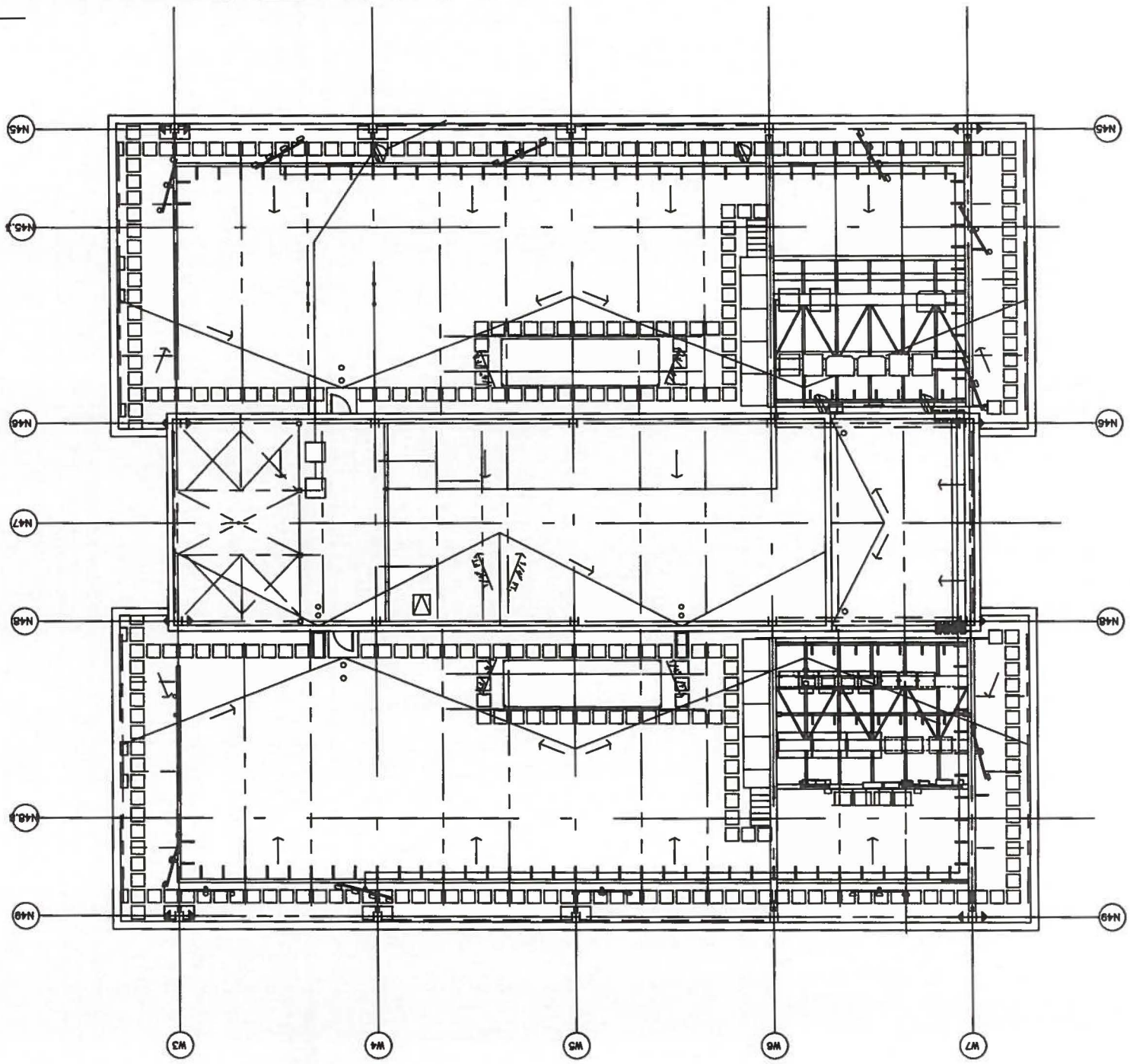

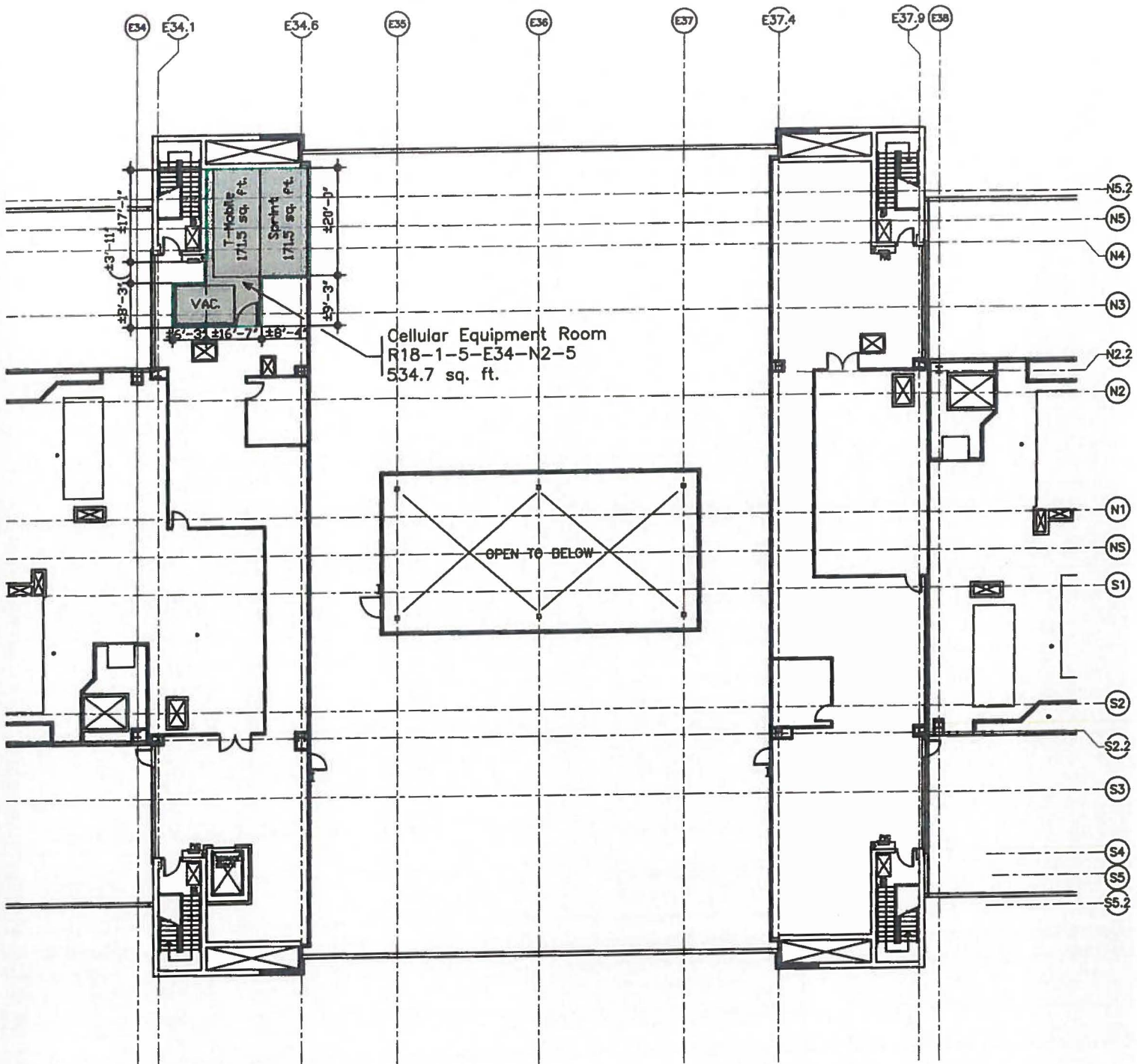

- CONC. WALL (BY CITY)
- STUD/GYPSUM WALL (BY CITY)
- GLASS WALL (BY CITY)
- TENANT LEASE LINE
- (H) (C) COLUMNS
- NIC = Not Included
(In Lease or Sq. Ft. Calc.)

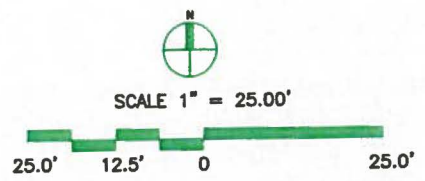

NOTE:
This exhibit depicts only approximate dimensions and square footage of leased area based upon planning data and is not intended to show dimensions for construction details.

DEN Property Management

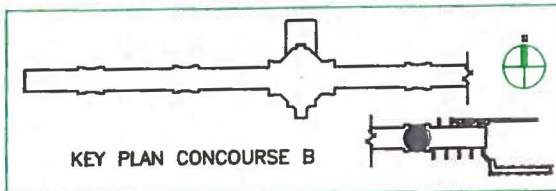

REVISED	DENVER INTERNATIONAL AIRPORT
	EXHIBIT A Concourse B Level 5 Cellular Equipment Room
CC#: cer	DATE: 03/24/17

R18-1-5-25-3

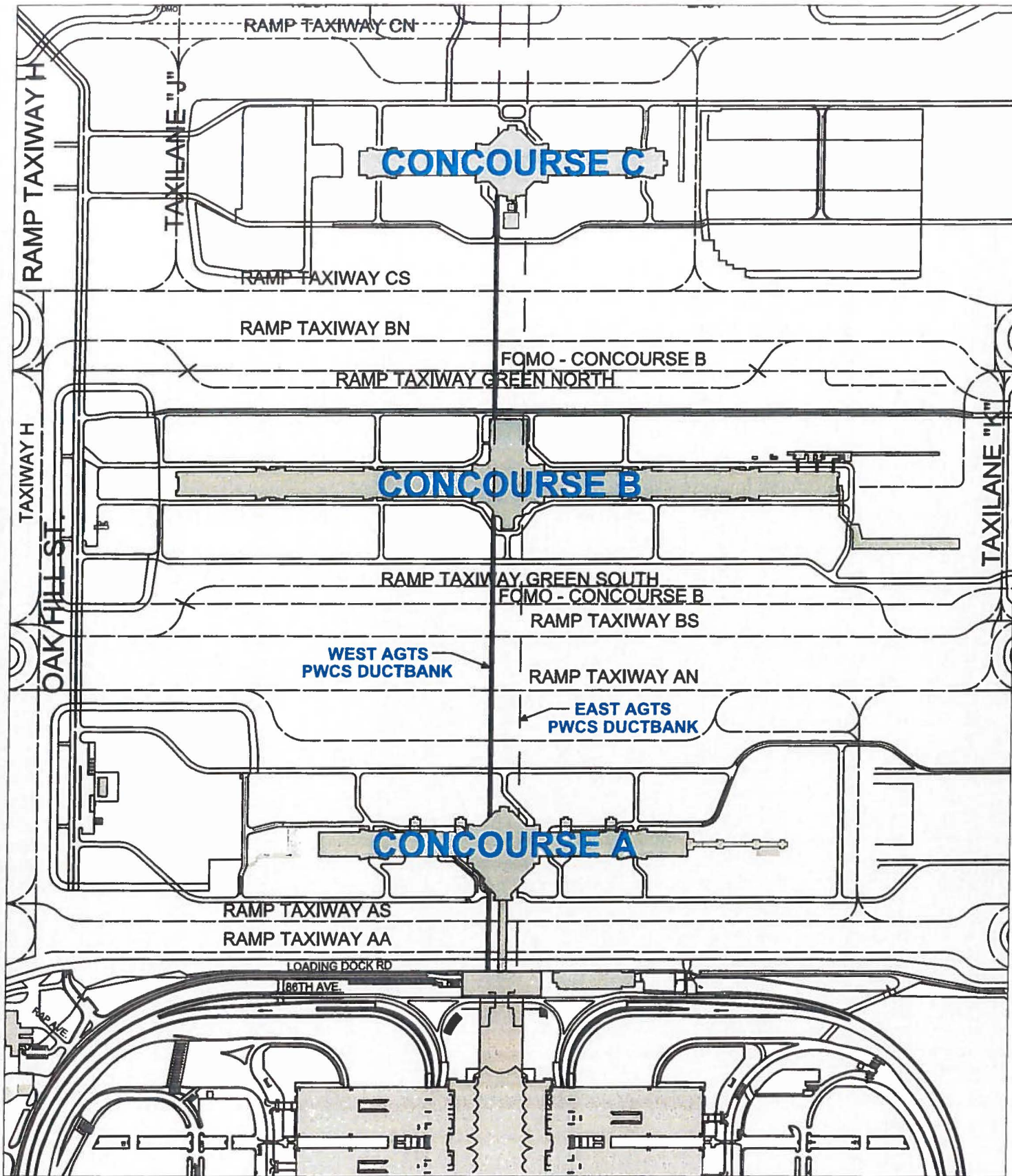

	DENVER INTERNATIONAL AIRPORT	REVISED
	VERIZON CDAS FIBER OPTIC NETWORK	
CC#:	DATE: 01/17/17	

R16-1-1-25-3

Exhibit B - Fee Schedule

Site License Fee \$61,300 Per Year
Cost of Living Increase 4% Per Year

Discounts for Available Spectrum

Greater than 120 MHz No Discount
Between 60 and 120 MHz 15% Discount
Less than 60 MHz 25% Discount

Discounts for Number of Cell Sites

Cell Sites 1-4 No Discount
Cell Sites 5-6 25% Discount
Cell Sites 7 and Greater 50% Discount

Other Fees (Adjusted Annually)

Ground Rent Per Part 120.08 (Developed Land)
Lease Space Rent Per Part 120.13 (Services)

Exhibit C - Cell Site Studies

INTENTIONALLY LEFT BLANK

Exhibit D - RF Site / Operational Standards



Radio Frequency (RF) Technical Standards

June 1, 2016

**City & County of Denver
DEPARTMENT OF AVIATION
DENVER INTERNATIONAL AIRPORT
Technologies Division – RF Systems Group**

SECTION 1 - GENERAL	3
1.01 RF DEFINITIONS	3
SECTION 2 - ADDING NEW & MODIFYING EXISTING RF SYSTEMS.....	4
2.01 APPLICATION FOR PROPOSED WIRELESS SYSTEMS AT DIA	4
2.02 MODIFICATION OF EXISTING SYSTEMS	5
SECTION 3 - RF OPERATIONAL REQUIREMENTS	6
3.01 PRE-OPERATIONAL STANDARDS	6
3.02 USER MAINTENANCE.....	6
3.03 DISPUTES BETWEEN USERS	7
3.04 FACILITY REGULATIONS.....	7
SECTION 4 - RF SITE TECHNICAL STANDARDS	8
4.01 POSTING OF INFORMATION	8
4.02 CHANGES.....	8
4.03 TRANSMITTERS.....	8
4.04 ADDITIONAL PROTECTIVE DEVICES	9
4.05 BASE STATION MOBILE RADIO RECEIVERS	9
4.06 ANTENNAS	10
4.07 TRANSMISSION LINES	10
4.08 CONNECTORS	11
4.09 GROUNDING - GENERAL	11
4.10 SHIELDING.....	11
4.11 POWER LIMITS.....	11
4.12 UNLICENSED DEVICES	11
SECTION 5 - RF INSTALLATION & CONSTRUCTION STANDARDS	12
5.01 CABINETS	12
5.02 CABLING	13
5.03 CONNECTORS	14
5.04 ANTENNAS AND MOUNTS	14
5.05 PREVENTION OF PASSIVE INTERMODULATION	15
5.06 RF DISTRIBUTION SYSTEM INTERFACE	15
SECTION 6 - RF SAFETY	15
6.01 RF SAFETY STANDARDS AND GUIDELINES	15
SECTION 7 - COMPLIANCE WITH RF STANDARDS	17
7.01 COMPLIANCE WITH DIA TECHNICAL STANDARDS	17
APPENDIX A - TYPICAL CONCOURSE ANTENNA MOUNT	18
APPENDIX B - EXAMPLE ANTENNA PLAN VIEWS.....	19
APPENDIX C - NFPA-178 EXAMPLE.....	20
APPENDIX D - RF APPLICATION	23
APPENDIX E - DIA RULES AND REGULATIONS	24
APPENDIX F - DIA RF APPLICATION PROCESS FLOW CHART	27

Section 1 - General

- A. These technical radio frequency (RF) standards, as may be amended from time to time by the Manager of Aviation, are intended to apply to all cases where transmission of signals of any type are contemplated by a User. Denver International Airport (DIA) reserves the right to review any and all proposed technologies and to reject any or all proposed installations if, in its own judgment, a proposed user's use or activity would limit, restrict, interfere with, prevent or otherwise damage any present or proposed telecommunications use by DIA, other tenants' or users.
- B. There is no intent whatsoever to limit the scope of application of these standards to radio technologies presently known or available. These standards are intended to include the entire electromagnetic radiation spectrum. Technologies not contemplated at the date of this instrument and including non-radio frequency bands (e.g. lightwave, infra-red, laser, etc.) are all subject to DIA's approval and must be demonstrated to be free of all harmful interference and to pose no threat to people, or equipment or activities of DIA and its other users. DIA may, at its discretion, require testing of user's equipment to determine compliance with these standards, or to determine a source of interference.

1.01 RF Definitions

- A. Radio Interference. Any emission, radiation or induction that endangers the function, degrades, obstructs, or repeatedly interrupts the telecommunications of Airport Operations, Public Safety, Federal Aviation Administration (FAA), Airline, or other users and users of RF communications. All wireless systems must operate in a shared environment with regard to the needs of other DIA communications and wireless operators.
- B. Harmful Radio Interference. Interference that causes circuit outages and/or message losses, as opposed to interference that is merely a nuisance or annoyance that can be overcome by appropriate measures. In order for radio interference to be considered harmful interference, it must degrade the performance of a communications system, or other passive or active electronic systems.
- C. Effective Radiated Power (ERP). Antenna input power (in decibels referenced to a milliwatt (dBm) plus the gain of the transmitting antenna in decibels (dB) relative to a dipole (dBd).
- D. User. Any tenant, person or organization operating a wireless device(s) at DIA is a user. This includes all licensed or unlicensed frequency bands.
- E. Unlicensed Devices. Unlicensed transmitters are typically low power transmitters and are regulated by Federal Communications Commission (FCC) Code of Federal Regulations 47 CFR §15. Unlicensed transmitters include but are not limited to; wireless headsets, WiFi access points, Family Radio Service

(FRS) radios, low power broadcast, and Bluetooth devices. DIA reserves the right to restrict use of these devices in all tenant agreements under section 40.21-2 -- Radio/Wireless Communications Systems of Rules and Regulations For The Management, Operation, Control And Use Of The Denver Municipal Airport System.

1.02 Transmitter Power Limit

- A. Personnel Exposure. RF Transmitters shall NOT be allowed to exceed the maximum level for public exposure to non-ionizing RF radiation, for any continuous interval, as set by the FCC's Office of Engineering & Technology without specific prior written approval by the DIA Technologies Division and properly installed signs. (See Section 6 for proper signage and guidelines.)
- B. Aircraft Operation Area (AOA). RF Transmitters are limited to 25 watts ERP without specific prior written approval by the DIA Technologies Division (special antenna or filtering may be required).
- C. Indoors. RF Transmitters are limited to 5 watts ERP. Mobile radios used with a power-supply for indoor operation must be limited to 5 watts or have an attenuator installed to effectively limit ERP to 5 watts.

Section 2 - Adding New & Modifying Existing RF Systems

2.01 Application for Proposed Wireless Systems at DIA

Users who propose to add channels to an existing radio system, to change the configuration of an existing radio system, or to construct new radio systems at DIA must submit a RF Application to the DIA Technologies Division – RF Systems Manager and receive written approval by the Technologies Division RF Engineer before proceeding. Applications may be obtained from the DIA Technologies Division upon request. Such applications shall be reviewed and a written response shall be given no later than thirty (30) days from the date plans and specifications are submitted. If applicant does not receive a written response within the time period set forth herein, such application is deemed denied. The RF Application shall, at a minimum, contain the following technical information:

- A. Frequency Band and Specific Frequencies. The specific frequency band or bands within which the system will operate, as well as all of the specific transmit and receive frequencies to be used.
- B. Power. The actual transmitter output power, antenna gain, and ERP will not exceed that specified in the FCC license for the proposed system/location.
- C. Transmission Line and Antenna Information. The specific type and length of transmission line to be used and the specific type of connectors to be used. The transmission line can be listed as a specific manufacturer's type number,

or generically (e.g. 1/2 inch solid outer conductor foam dielectric line). Antenna type, manufacturer, model number, and gain relative to a dipole should be specified for both transmit and receive antennas. Directional antennas should include a diagram of the antenna's radiating pattern.

- D. Modulation/Multiple Access Method. The specific type of modulation used in the system (e.g. AM, SSB, FM, ACSSB, CDMA, TDMA, etc.). For digital modulation techniques such as TDMA and CDMA, the channel bandwidth occupied by the system should be specified.
- E. Coverage Requirements. Provide a general description of the area the system is designed to cover. Distinguish between systems which require wide area coverage over much of the airport and systems which require coverage only in limited areas, such as in the immediate vicinity of the Concourses or underground areas.
- F. Underground Coverage. Specify the requirements for underground coverage so that the addition of the proposed system to the Radio Frequency Distribution System (RFDS) can be evaluated.
- G. Proposed Transmit (TX)/Receive (RX) Sites.

1. Identify if a specific site requested is a new transmitting/receiving site. In some cases, DIA will instruct applicants where transmitting antennas must be located to ensure compatibility with other RF systems at DIA (see Appendix B for Concourse roof tops).
2. Other applications for existing sites where specific antenna mounting locations are available (e.g. on a tower at the antenna farm or roof top of a building), the specific mounting location and methods shall be specified by DIA. This determination will be based on the results of the interference study performed on the proposed system, per the user's RF Application (See Appendix A, B, and C).
3. FAA Form 7460 may be required by users constructing towers for antennas, or other structures that infringe on the airspace regulations at DIA. It is up to the applicant to determine if an FAA Form 7460 is required and to provide a copy of the FAA Form 7460 with the RF Application.
4. The Technologies Division RF Manager and RF Engineer are the final approving authorities for all RF Applications and site approvals.

H. Combiners and Filters.

1. Reference section 4.03 (B) below.

2.02 Modification of Existing Systems

- A. Modifications to existing systems require an RF Application to be submitted as detailed in paragraph 2.01 above.

- B. Modifications for additional capacity at a proposed site are limited by potential interference considerations, physical space limitations, and/or RF radiation exposure limits. DIA reserves the right to evaluate different distributions of channel capacity among the various service providers operating at a site to assure that physical capacity is distributed equitably.
- C. Capacity limitations for each provider operating a transmitter/receiver shall be restricted by:
 - 1. Non-Ionizing Electromagnetic Radiation limits.
 - 2. Physical space limitations for antennas or base station equipment.
 - 3. Potential for interference from additional users or from additional channels.
 - 4. Requirements for maintenance of space for future users.
- D. Previously approved frequencies can be turned on/off at anytime.

Section 3 - RF Operational Requirements

3.01 Pre-Operational Standards

- A. All users shall furnish the following to the DIA Site Project Manager prior to installation of any equipment:
 - 1. Executed Lease, License Agreement, Temporary Site Access Permit or other approved permit/contract.
 - 2. Copy of the current FCC license or pending application, and construction permit, as appropriate.
 - 3. Accurate block diagrams showing all system interface components with (active or passive) gains and losses in dB, along with power levels.
 - 4. Detailed construction drawings.
 - 5. Antenna type and mounting arrangements. DIA shall coordinate the equipment location for all potential users.
- B. An intermodulation (IM) study may be required at the discretion of the DIA Technologies Division's RF Engineer prior to installation of any equipment. In such cases, the IM study shall be performed by DIA or its approved consultant. Results of the IM study shall determine whether a potential transmitter is permitted to operate on the site or whether additional interference protection devices are required. Payment of all costs associated with any IM study shall be the full responsibility of the applicant.

3.02 User Maintenance

- A. User shall not make alterations, changes or modifications to any installation in terms of number of transmitters, type of equipment, antennas or antenna height, frequencies used, power output of transmitters or alter any other

technical parameters without prior written approval by DIA, as detailed in Section 2 above.

- B. User equipment approved for operation shall be properly maintained in accordance with the manufacturer's specifications to prevent it from becoming a source of interference or from becoming a safety hazard.

3.03 Disputes Between Users

- A. The DIA Technologies Division, RF Manager, and the RF Engineer have final authority with respect to technical parameters, equipment placement, antenna location, as well as installation workmanship. Recommendations and decisions of the RF Manager and the RF Engineer shall be final and binding.
- B. The DIA Technologies Division, RF Manager and the RF Engineer shall be the final authority between users in the interpretation of these RF Technical Standards.

3.04 Facility Regulations

- A. All areas in and around user's equipment and work area shall be kept clean and neat at all times. Exterior areas on the Property including roads and parking lots shall be kept clean. User's trash and other unused materials shall be removed immediately from the property and not stored on the premises in any manner.
- B. Tools, test equipment and work materials shall be stored only in areas with prior approval by the DIA RF Manager. It shall be the user's responsibility to secure stored materials against theft and vandalism. All stored materials other than small tools and parts are to be tagged with owner's name.
- C. Food and drink shall be permitted on the premises. However, all trash related to same shall be removed. Care shall be taken not to spill or litter equipment on the premises with food or drink.
- D. No alcoholic beverages shall be taken on the premises by user, its agents or employees.
- E. Users shall not use or permit the use of the premises for lodging or sleeping.
- F. Smoking, open flame or welding shall not be permitted inside of buildings.
- G. Users shall not allow or authorize entry into the premises for any purpose whatsoever to any person performing maintenance work for the user without following DIA Security processes and procedures.

Section 4 - RF Site Technical Standards

4.01 Posting of Information

- A. The following information must be posted by the user on or near equipment cabinets:
1. Copy of the current FCC station license and an Identifier Card with the following information:
 - a. Name of licensee and contact information.
 - b. Name and telephone number of responsible technician or engineer.
 - c. FCC call sign.
 - d. Transmit and receive frequencies.
 - e. Authorized output power & ERP.
 - f. Type of emission.
 - g. Antenna type, gain, & location installed.
 - h. Transmission line type.
- B. Unidentified equipment shall be considered unauthorized and may be shut-down or possibly removed from the site.

4.02 Changes

Changes are not permitted to any RF installation without submitting an RF Application to the DIA Technologies Division and receiving prior written approval by the DIA Technologies Division RF Manager and RF Engineer before proceeding. Unauthorized changes to frequencies, antennas, ERP, or approved configuration may be punishable as set forth in Section 7.01 (B) below.

4.03 Transmitters

- A. As a minimum, each transmitter shall employ a dual stage isolator followed by a single cavity bandpass filter. All transmitters must have external harmonic (low pass) filters. Low pass filters shall attenuate the second harmonic by at least 60 dB and the third harmonic by at least 50 dB. The following minimum specifications apply:
1. 30-76 MHz:
Isolators - minimum of 60 dB.
TX cavity - minimum of 20 dB rejection at + 1 MHz.
 2. 118-174 MHz:
Dual Stage Isolators - minimum of 60 dB.
TX cavity - minimum of 25 dB rejection at + 1 MHz.
 3. 406-512 MHz:
Dual Stage Isolators - minimum of 60 dB.
TX cavity - minimum of 25 dB rejection at + 1 MHz.
 4. 851-940 MHz:

Dual Stage Isolators - minimum of 60 dB.

Tx cavity - minimum of 20 dB rejection at + 5 MHz.

5. Cellular, PCS, and 220 MHz combiners: These systems require special consideration. Additional details and engineering specifications may be required.

- B. Bandpass filters shall follow the isolator because ferrite isolators are nonlinear and can create harmonics. Please note that most bandpass cavity filters pass odd harmonics of the tuned frequency, so an external lowpass filter is required. Transmitter combiners shall be considered on a case-by-case basis. Please submit all combiner technical information with the RF application to the DIA Technologies Division.

4.04 Additional Protective Devices

- A. Additional protective devices may be required based upon DIA Technologies evaluation of the following additional information per the RF Application submitted:

1. TX and RX IM products, particularly second and third order mixes.
2. Antenna location and type.
3. Combiner / multicoupler configurations.
4. Transmitter specifications.
5. Receiver specifications.
6. Historical problems.
7. Transmitter to transmitter isolation.
8. Transmitter to antenna isolation.
9. Transmitter to receiver isolation.
10. Calculated and measured level of IM products.
11. Transmitter output power.
12. Transmit ERP.
13. Spectrum analyzer measurements.
14. Standing Wave Ratio (SWR) measurements.
15. Existing cavity filter selectivity.
16. Antenna to antenna proximity.

4.05 Base Station Mobile Radio Receivers

- A. DIA has high RF levels in all mobile radio bands. Receiver amplifiers must have good IM rejection, high compression point and high third order intercept. If interference is encountered and it is determined the receiver is not performing according to manufacture specifications, DIA will require receiver improvements before requesting changes to other user equipment or configurations.
- B. Filters are required for base stations using mobile radio receivers. Single receivers must employ a minimum of a single cavity bandpass filter (use TX filter performance in 4.03 A 1 through 5 for RX filter performance). Additional filter isolation may be required in special cases. Receiver multicouplers must

use a bandpass filter prior to the multicoupler amplifier. Duplexed systems should meet both the TX and RX filter specifications.

4.06 Antennas

- A. Select antennas designed to minimize passive intermodulation generation. Unless the antenna is configured for simplex or duplex operation, transmit and receive antennas should be separated vertically on the tower or other support structure. Antenna locations shall be designated by the RF Engineer. All antennas must be DC grounded to the tower or supporting structure unless otherwise approved by the RF Engineer.
- B. Antennas proposed for installation on DIA buildings shall provide an approved antenna mount per RF Technical Standards specifications (see Appendix A). No ballast mount antenna or roof penetrations are permitted on the bonded membrane roofing system. If penetrations are unavoidable, penetrations shall be made by a DIA approved roofing contractor in order to maintain the warranty on the roof.
- C. DIA maintains a map of potential antenna locations on each major facility. Users proposing the installation of antennas and mounts shall obtain a copy of the map for the proposed facility. The user may indicate the preferred locations and submit this with the RF Application (see Section 2 above and Appendix B).

4.07 Transmission Lines

- A. Coaxial cable should be grounded at the top and bottom of the cable run with an Andrew ground kit or approved equivalent. Ground conductors must run straight down with no sharp bends (bends increase the impedance of the line; low impedance is required for good lightning protection). DIA requires that the line be marked for identification purposes. Bands of colored electrical tape at the bottom, middle and top of the run (similar to a resistor color code) are required. Installation of a coaxial surge arrester at the bulkhead is also required. All exterior transmission lines must have solid outer conductors. Transmit and receive lines should be separated by at least one foot from cabinet to antenna. All transmission lines must meet or exceed accepted industry standards.
- B. Transmission lines must be labeled at the antenna with a stainless steel stamped identification tag permanently affixed to the transmission line. The tag will contain the following minimum information:
 - 1. Owner
 - 2. Contact Number
 - 3. Frequency or frequencies of operation
 - 4. Date of installation
 - 5. DIA permit number
 - 6. FCC Call Sign (if applicable)

4.08 Connectors

Connectors are often sources of RF leakage and passive intermodulation. UHF connectors (PL259) are not allowed. 7/16 DIN connectors should be used at 800 MHz and above; N connectors are authorized at 800 MHz. Connectors using dissimilar metal contacts or ferrous materials (e.g., nickel plating) are not allowed. The preferred connector uses a silver plated body with gold plated inner conductor. Any exception to the above must be approved by RF Manager or RF Engineer in writing.

4.09 Grounding - General

Equipment grounding and bonding shall be accomplished in accordance with National Electrical Codes, NFPA-178, Lightning protection code (see Appendix C). Properly installed transmission line outer-conductor grounding kits and center-conductor surge-suppressors such as a polyphaser or equivalent are required at the building entry point (bulkhead). Coordinate with the DIA Site Project Manager for guidance on grounding and bonding at a particular facility. Note that DIA has specific specifications for grounding and bonding at the airport. Refer to Exhibit A for detailed grounding instructions.

4.10 Shielding

RF interference can get directly into the electronics of a receiver or transmitter. Cabinet doors and all stock RF shielding must be in place and maintained to the manufacturer's specifications. Transmitters determined to be emitting spurious emissions will be considered a violation (see paragraph 7.01 B).

4.11 Power Limits

- A. Cellular, ESMR, and PCS/PCN facilities operating on DIA property shall limit their ERP to 25 Watts (+ 44dBm) per RF channel at all locations, without specific prior written approval by the DIA Technologies Division, except the West Antenna Farm, Old Toll Plaza Site, and Pena Blvd. sites. For wideband CDMA systems this power limit applies to the equivalent power over the entire bandwidth occupied by the CDMA RF channel discussed in 4.11 B. below.
- B. Due to frequency spreading with CDMA systems, there is less power density in each piece of spectrum, equivalent to narrow-band analog use. For a CDMA carrier bandwidth of 1.25MHz, the total channel power limit is 200 Watts (+53 dBm). These maximum ERP levels are to help reduce intermodulation and receiver desensitization in portable or mobile radios authorized for use at DIA. In some locations additional transmitter filtering or lower power limits may be required of the user by DIA. This concept applies to broader bandwidth UMTS, LTE and other broadband transmissions.

4.12 Unlicensed Devices

A. Unlicensed devices as defined by FCC 47 CFR §15 shall be subject to the RF application process and all guidelines as noted above. No approved unlicensed device shall be modified to increase RF power output or modifications to the antenna radiating element. Any unlicensed device shall be maintained in good working order with no physical or electrical damage. In addition the following requirements are required.

- 1) Unintentional Transmitters. Unintentional transmitters such as personal computers or other computing devices shall be Class A devices.
- 2) Intentional Transmitters Broadcast Band. Intentional radiators in the broadcast band are discouraged for use on Airport property.
- 3) Intentional Transmitters All Other Bands. FCC Part 15 Intentional transmitters in all other bands shall be subject to the RF application process and the requirements as noted above.
- 4) In House Broadband Over Power Line. In house broadband over power line is not allowed on airport facilities.

B. 2.4 and 5 GHz Unlicensed Band Channel Plan.

Wireless Fidelity (WiFi) is a growing wireless connection medium able to handle high data rates in relatively small areas, typically a 300 foot radius. The FCC allocated two bands for this service, 2.4 GHz and 5 GHz. Because of the recent growth of devices utilizing WiFi technology, tenants are encouraged to use channel 1 in the 2.4 GHz band and channels 36, 40, 92, and 96 in the 5 GHz band.

Section 5 - RF Installation & Construction Standards

All installations shall be completed in a professional manner by qualified technical personnel and are subject to approval by the RF Manager and the RF Engineer prior to rendering any system operational. All construction must follow practices described in the DIA Tenant Development Guidelines (TDGs) as provided by the Engineering Division and applicable standards.

5.01 Cabinets

- A. All RF devices including duplexers, isolators, cavities, switches, etc. shall be located inside grounded cabinets.
- B. Properly shielded devices may be mounted on grounded relay racks with prior written approval by DIA.

- C. All cabinets must be bonded together and to the ground system with at least #6 copper wire or 1" copper strap.
- D. All doors must be on and closed.
- E. All holes larger than 1" must be covered with copper screen or solid metal plates.
- F. Cabinets shall be spaced with no less than 3-Ft. of front and back clearance for maintenance access.

5.02 Cabling

- A. All cables exiting through a building bulkhead must use approved weather-proof seals and fasteners (NO tape). All antenna cables must be jacketed Heliac™ or equivalent. Kinked or cracked cable shall NOT be permitted and may be considered a violation (see paragraph 7.01 B). Antenna cables must be tagged at building bulkhead entry/exit points in the same manner as at the antenna (see 4.07(B)) with weatherproof identification tags. An additional tag is required in the equipment room if the building bulkhead entry/exit point is not in the equipment room.
- B. Any unused cable must be terminated or removed. Unused cable includes RF cable that is no longer part of the transmitting/receiving system. Fiber optic, telephone or network cables need not be removed.
- C. All antenna transmission lines shall be grounded at tower top (50 Ft. or above) and bottom, and at the building entrance with approved grounding kits.
- D. All coaxial cable shall be individually attached to the tower legs or wave-guide hangers. This location shall be assigned by DIA. Attachment of coaxial cable shall be by insulated stainless steel clamps and hangers or ultraviolet-stabilized nylon ties spaced a maximum of four (4) feet apart for both towers and rooftops.
- E. All transmit interconnecting cables/jumpers must be solid copper outer conductor (e.g. Superflex™ or equivalent), or double-braided silver (RG-214/U or equivalent).
- F. All receiver cabling must be 100% shielded coaxial cable or double-shielded silver cable.
- G. All rooftop cable must be run on the antenna mounting structure and/or cable trays.
- H. All inside cable must be run in troughs or cable trays.
- I. All AC line cords must be 3 conductor with grounding plugs.

- J. Where no troughs or cable trays exist, all cable must be tied at 3' or closer intervals.
- K. Power and phone line cables shall be protected by grommets where they enter cabinets. Cable shall not be wrapped with black tape.
- L. Lightning protection must be provided for antenna, power and control lines. (see exhibit C)
- M. Cable between an equipment cabinet and building exit must be an uninterrupted, continuous length without splices or adapters.

5.03 Connectors

- A. Connectors must be 50-ohm type, including chassis/bulkhead connectors. Connectors must be built in accordance with manufactures instructions. Connectors must be properly fabricated (soldered if applicable) if field installed.
- B. Connectors must be taped and coated with a sealing agent at least 4" onto the jacket if exposed to weather.
- C. Connectors must be pliers tight as opposed to hand tight.
- D. Connectors must be silver plated or brass.
- E. Connectors must be electrically and mechanically equivalent to OEM connectors.

5.04 Antennas and Mounts

- A. No welding to any portion of the tower structures. All antenna mounts or supporting structures shall be stainless steel or hot-dipped galvanized steel. Any hot dipped galvanized pipes or brackets that have been field cut must be sprayed with a minimum of two coats of cold galvanizing paint or stainless steel paint (see Appendix A for typical Concourse Antenna Mount).
- B. All antennas should be fiberglass or ABS plastic enclosed. Exposed metal antennas shall not be permitted on the site unless treated by chromate conversion (irridite).
- C. All antennas that become corroded or damaged must be replaced in a timely fashion.
- D. No ballast mount antennas are permitted.
- E. Applicant must comply with EIA-222G (or most recent revision) for a basic wind speed of 85 miles per hour dry (Uniform Building Code for Denver County) or 0.866 times 85 miles per hour with ½ inch radial solid ice (56 lbs/cubic foot. This requirement is critical to applications at DIA antenna towers 1 through 4.

- F. The applicant will provide results of the study (5.04 (E) above) and will be at applicant's expense. Study must be stamped by a licensed professional engineer in the State of Colorado. In some cases, a study may not be required if previous studies have identified antenna locations that are vacant but considered in the most recent studies as available or filled.

5.05 Prevention of Passive Intermodulation

- A. To help prevent passive intermodulation, the following practices shall be followed at DIA sites:
1. 7/16 DIN connectors are required for new systems with a transmitter power of 100 watts or greater.
 2. All connectors shall be non-ferrous (no nickel).
 3. Do not use UHF connectors (PL259) at any frequency.
 4. All coaxial cables shall be solid shield (e.g., Helix™, Flexwell™ or equivalent).
 5. Transmission lines shall be grounded at the top and bottom of each run.
 6. All bonds shall be clean, tight, free of corrosion, and have no dissimilar metals.
 7. Transmit and receive lines will be physically separated.
 8. Use antennas designed to prevent passive intermodulation.

5.06 RF Distribution System Interface

- A. Users shall be responsible for all equipment necessary to interface with the RF Distribution System (RFDS). Input to the RFDS downlink (base-to-mobile) is a type N connection with a maximum input of +18 dBm per carrier. Output of the RFDS uplink (mobile-to-base) shall provide the base-station receiver all in-band signals from portable & mobile radios in the distributed areas of coverage via the respective band (450, 460, 800, cellular, 900). The receive port connection is through a type N connector on the tower RFDS rack, assigned to the user by DIA upon RF Application/Installation approval.
- B. User installations requiring RFDS connections to couple signals from antenna lines must provide adequate isolation between the RFDS and antennas. Coupling or summing devices must have 20 dB minimum port-to-port isolation.

Section 6 - RF Safety

6.01 RF Safety Standards and Guidelines

- A. The engineering, design, configuration, installation, and maintenance of radio facilities on the site shall be accomplished in a manner that minimizes downward radiation. Changes to proposed systems may be directed by DIA to comply with this objective.

B. The following guidelines are applicable:

1. All personnel entering the site must be authorized.
2. Obey all posted signs.
3. Assume all antennas are active unless proven otherwise.
4. Before working on an antenna, notify the owner and disable the transmitter. In collocated sites, all users and owners must be notified to disable all transmitters.
5. Use a radio frequency (RF) personal monitor when working near antennas.
6. Never operate transmitters without shields.
7. Post a warning sign at the base of your tower. i.e. CAUTION – OVERHEAD WORK IN PROGRESS

C. Power densities on towers can be much higher than at ground level. For this reason, tower climbers shall request power reductions from high-power users and carry RF personal monitors when climbing towers. The Site Manager can tell you which transmitters should be turned down before climbing your tower.

D. Federal Government guidelines regarding human exposure to radio frequency energy are found in the Code of Federal Regulations (CFR) Title 47, Parts 1.1307-1.1310.

E. Available sources for warning signage are: www.radhaz.com or TESSCO.

Section 7 - Compliance with RF Standards

7.01 Compliance with DIA Technical Standards

- A. DIA reserves the right to inspect all systems to ensure compliance with installation and technical standards. Users must cooperate with DIA if requested to demonstrate proper operation of filters and other protective devices installed in the user's system.
- B. Violation Notice. User (system owner and/or operator) shall respond as directed to any notice by DIA that a suspected offense and violation of these RF Technical Standards herein exists. Per the revised DIA Rules and Regulations (Section 1.13.8, General Penalty), violations confirmed by DIA are subject to:
 - 1. Possible fines (penalty) of up to \$999 per day; each day an offense or violation continues shall constitute a separate offense or violation.
 - 2. Possible revocation of any privilege shall be in addition to any penalty.
 - 3. Possible disconnection and/or removal of systems.
- C. Disconnection and/or removal of systems and/or equipment. Any system or equipment installed or operating at DIA that does not have an approved RF Application associated on file approving the installation and operation will be considered in violation of these standards. Every attempt will be made to determine the user/owner of the system and/or equipment. If the RF Manager is unable to determine the user/owner, DIA reserves the right to disconnect and/or remove and may even dispose of the equipment at the discretion of the RF Manager.

* * * * *

Appendix A - Typical Concourse Antenna Mount

Appendix B - Example Antenna Plan Views

For Specific Drawings at Desired Location

Contact: DIA Technologies Division
Leonard Spomer – (303) 342-2879
Darryl Smith – (303) 342-2059

Appendix C - NFPA-178 Example

An ordinary structure shall be any structure that is used for ordinary purposes whether commercial, industrial, farm, institutional, or residential. Ordinary structures not exceeding 75 ft (23 m) in height shall be protected with Class I materials as shown in Table 3-1.1(a). Ordinary structures greater than 75 ft (23 m) in height shall be protected with Class II materials as shown in Table 3-1.1(b). If part of a structure is over 75 ft (23 m) in height (e.g., steeple) and the remaining portion does not exceed 75 ft (23 m) in height, the requirements for Class II air terminals and conductors shall apply only to that portion exceeding 75 ft (23 m) in height. Class II conductors from the higher portion shall be extended to ground and shall be interconnected with the balance of the system.

Table 3-1.1(a) Minimum Class I Material Requirements

Type of Conductor		Copper		Aluminum	
		Standard	Metric	Standard	Metric
Air Terminal, Solid	Diameter	3/8 in.	9.5 mm	1/2 in.	12.7 mm
Air Terminal, Tubular	Diameter	5/8 in.	15.9 mm	5/8 in.	15.9 mm
	Wall Thickness	0.033 in.	0.8 mm	0.064 in.	1.6 mm
	Size ea. Strand	17 AWG		14 AWG	
Main Conductor, Cable	Wgt. per Length	187 lb/1000 ft	278 g/m	95 lb/1000 ft	141 g/m
	Cross Sect. Area	57,400 CM	29 mm ²	98,600 CM	50 mm ²
Main Conductor, Solid Strip	Thickness	0.051 in.	1.30 mm	0.064 in.	1.63 mm
	Width	1 in.	25.4 mm	1 in.	25.4 mm
Bonding Conductor, Cable (solid or stranded)	Size ea. Strand	17 AWG		14 AWG	
	Cross Sect. Area	26,240 CM		41,100 CM	
Bonding Conductor, Solid Strip	Thickness	0.051 in.	1.30 mm	0.064 in.	1.63 mm
	Width	1/2 in.	12.7 mm	1/2 in.	12.7 mm

Table 3-1.1(b) Minimum Class II Material Requirements

Type of Conductor		Copper		Aluminum	
		Standard	Metric	Standard	Metric
Air Terminal, Solid	Diameter	1/2 in.	12.7 mm	5/8 in.	15.9 mm
Main Conductor, Cable	Size ea. Strand	15 AWG		13 AWG	
	Wgt. per Length	375 lb/1000 ft	558 g/m	190 lb/1000 ft	283 g/m
	Cross Sect. Area	115,000 CM	58 mm ²	192,000 CM	97 mm ²
Bonding Conductor, Cable (solid or stranded)	Size ea. Strand	17 AWG		14 AWG	
	Cross Sect. Area	26,240 CM		41,100 CM	
Bonding Conductor, Solid Strip	Thickness	0.051 in.	1.30 mm	0.064 in.	1.63 mm
	Width	1/2 in.	12.7 mm	1/2 in.	12.7 mm

3-2 Materials.

Protection systems shall be made of materials that are resistant to corrosion or acceptably protected against corrosion. Combinations of materials that form electrolytic couples of such a nature that in the presence of moisture corrosion is accelerated shall not be used. One or more of the following materials shall be used:

(a) Copper. Where copper is used, it shall be of the grade ordinarily required for commercial electrical work, generally designated as being of 95-percent conductivity when annealed.

(b) Copper Alloys. Where alloys of copper are used, they shall be as substantially resistant to corrosion as copper under similar conditions.

(c) Aluminum. Where aluminum is used, care shall be taken not to use it where contact could be made with the earth or anywhere it could rapidly deteriorate. Conductors shall be of electrical grade aluminum.

3-2.1

Copper lightning protection materials shall not be installed on aluminum roofing, siding, or other aluminum surfaces.

3-2.2

Aluminum lightning protection materials shall not be installed on copper surfaces.

3-3 Corrosion Protection.

Precautions shall be taken to provide the necessary protection against any potential deterioration of any lightning protection component due to local conditions. Copper components installed within 24 in. (600 mm) of the top of a chimney or vent emitting corrosive gases shall be protected by a hot-dipped lead coating or equivalent.

3-4 Mechanical Damage or Displacement.

Any part of a lightning protection system that is subject to mechanical damage or displacement shall be protected with a protective molding or covering. If metal pipe or tubing is used around the conductor, the conductor shall be electrically connected to the pipe or tubing at both ends.

3-5 Use of Aluminum.

Aluminum systems shall be installed in accordance with other applicable sections and with the following:

- (a) Aluminum lightning protection equipment shall not be installed on copper roofing materials or other copper surfaces, or where exposed to the runoff from copper surfaces.
- (b) Aluminum materials shall not be used where they come into direct contact with earth. Fittings used for the connection of aluminum-down conductors to copper or copper-clad grounding equipment shall be of the bimetallic type. Bimetallic connectors shall be installed not less than 18 in. (457 mm) above earth level.
- (c) Connectors and fittings shall be suitable for use with the conductor and the surfaces on which they are installed. Bimetallic connectors and fittings shall be used for splicing or bonding dissimilar metals.
- (d) An aluminum conductor shall not be attached to a surface coated with alkaline-base paint, embedded in concrete or masonry, or installed in a location subject to excessive moisture.

3-6 Strike Termination Devices.

Strike termination devices shall be provided for all parts of a structure that are likely to be damaged by direct lightning flashes. Metal parts of a structure that are exposed to direct lightning flashes and that have a metal thickness of 3/16 in. (4.8 mm) or greater shall only require connection to the lightning protection system. Such connections shall provide a minimum of two paths to ground. Strike termination devices shall not be required for those parts of a structure located within a zone of protection.

3-9.5 Conductor Bends.

No bend of a conductor shall form an included angle of less than 90 degrees, nor shall it have a radius of bend less than 8 in. (203 mm). (See Figure 3-9.5.)

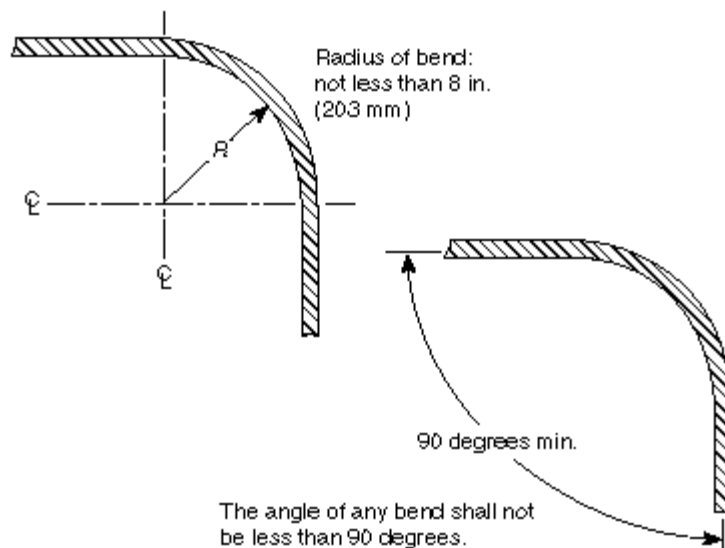

Figure 3-9.5 Conductor bends.

3-9.6 Conductor Supports.

Conductors shall be permitted to be coursed through air without support for a distance of 3 ft (0.9 m) or less. Conductors that must be coursed through air for longer distances shall be provided with a positive means of support that will prevent damage or displacement of the conductor.

3-10 Conductor Fasteners.

Conductors shall be securely fastened to the structure upon which they are placed at intervals not exceeding 3 ft (1 m). Attached by nails, screws, bolts, or adhesives as necessary, the fasteners shall not be subject to breakage and shall be of the same material as the conductor or of a material equally resistant to corrosion as that of the conductor. No combination of materials shall be used that will form an electrolytic couple of such a nature that, in the presence of moisture, corrosion will be accelerated.

3-11 Masonry Anchors.

Masonry anchors used to secure lightning protection materials shall have a minimum outside diameter of 1/4 in. (6.4 mm) and shall be set with care. Holes made to receive the body of the anchor shall be of the correct size, made with the proper tools, and preferably made in the brick, stone, or other masonry unit rather than in mortar joints. When the anchors are installed, the fit shall be tight against moisture thus reducing the possibility of damage due to freezing.

3-12 Connector Fittings.

Connector fittings shall be used at all "end-to-end," "tee," or "Y" splices of lightning conductors. They shall be attached so as to withstand a pull test of 200 lb (890 N). Fittings used for required connections to metal bodies in or on a structure shall be secured to the metal body by bolting, brazing, welding, or using high-compression connectors listed for the purpose. Conductor connections shall be of the bolted, welded, high compression, or crimp-type. Crimp-type connections shall not be used with Class II conductors.

3-17 Metal Antenna Masts and Supports.

Metal antenna masts or supports located on a protected structure shall be connected to the lightning protection system using main size conductors and listed fittings unless they are within a zone of protection.

Appendix D - RF Application

Appendix E - DIA Rules and Regulations

DENVER INTERNATIONAL AIRPORT

Rules and Regulations (Excerpts)
July 1, 2003

FORWARD (Effective March 9, 1994)

A. INTRODUCTION

Pursuant to the Provisions of Chapter 5 and Sections 5-15 and 5-16 of the Revised Municipal Code of the City and County of Denver, the following Rules and Regulations for the management, operation, control and use of the Denver Municipal Airport System, are hereby adopted and issued effective March 9, 1994, or such later date as in established by the City as the opening date of Denver International Airport. All rules and regulations previously issued or adopted are hereby revoked and supplanted as of such date.

B. AUTHORITY

The revised Municipal Code of the City and County of Denver, as amended, provides in part as follows:

1.13.8 GENERAL PENALTY

(a) Whenever in any section of this Code or any section of a rule or regulation promulgated hereunder the doing of any act is required, prohibited, or declared to be unlawful and no definite fine or penalty is provided for a violation thereof, any person who shall be convicted of a violation of any such section shall, for each offense, be fined in a sum not more than Nine Hundred Ninety-Nine Dollars (\$999.00) or imprisoned not to exceed one hundred eighty (180) days, or both so fined and imprisoned. Each day an offense and violation continues shall constitute a separate offense and violation.

(b) The suspension or revocation of any license, certificate or other privilege conferred by the City shall not be regarded as a penalty for the purpose of this code, but shall be in addition to the penalty provided in subsection (a).

* * * * *

40.04 ALTERATIONS OF AIRPORT FACILITIES (Revised January 10, 2003)

No tenant or permittee shall make any alterations of any nature whatsoever to any building, ramp or other Airport space, nor erect any building or other structure without prior written permission of the Manager. Following such permission from the Manager, the details of all such changes and alterations must be submitted to the Airport Engineering office and must be in compliance with the TDGs. Alterations made in areas where fire sprinkler systems are provided shall be designed so as not to interfere with sprinkler protection.

* * * * *

40.20 TELECOMMUNICATIONS (Revised January 10, 2003)

40.20-1 AIRPORT PREMISE WIRING AND COMMUNICATIONS SYSTEMS_s

No tenant, lessee or other Airport user shall make any modifications or connections of any nature whatsoever to the Airport Premise Wiring and Communications System (PWCS) owned and operated by the City without prior written permission of the Manager of Aviation. No equipment or facilities of any kind shall be installed or otherwise occupy airport designated telecommunications rooms or space without prior written permission of the Manager of Aviation.

Airport PWCS includes but is not limited to the following:

All copper and fiber optic backbone, station cabling and termination systems; SONET Backbone and FDDI rings, supporting Local Area Networks (LANS), and voice, data, and video systems and elements,, owned and operated by the City and operated by the City or its telecommunications service contractor, including but not limited to: Fire Alarm Systems, Security Card Access Systems, Closed Circuit Television System, Voice Paging Systems, Public Affairs , Television System, Parking and Ground Transportation Systems.

40.20-2 RADIO/WIRELESS COMMUNICATIONS SYSTEMS.

No tenant, lessee or other airport user shall install, modify or operate any Radio/Wireless Communications System anywhere on the airport without first submitting a written application to the Technologies Division of the Airport and receiving written permission to proceed from the Manager of Aviation.

Following such permission from the Manager, the physical and technical details of all such Radio/Wireless Communications System installation, modification and operation must be submitted for review and action to both the Airport Division of Planning & Development Division and the Airport Technologies Division. Installation, modification and operation of any radio/wireless communication system shall at all times comply with DIA Radio Frequency (RF) Technical Standards available from the Airport Technologies Division.

A Radio/Wireless Communication Systems shall mean, is:

1. Traditional public safety and industrial two-way radio, including airline “air to ground” and “ground to ground” systems. (AL)
2. Trunked wide- area two-way radio, such as the Countywide 800 MHz system, such as City and County of Denver Public Safety.
3. Fixed base station or control system providing commercial services offered by cellular companies, SMR (Specialized Mobile Radio) and ESMR (Enhanced Specialized Mobile Radio) providers and PCS (Personal Communications System) providers, paging systems providers and mobile data providers.
4. Data transmission for specialized purposes on the City owned and operated radio systems using frequencies assigned to the City, such as the Metro AVL system., and
5. Data transmission services provided by commercial vendors such as Ricochet and Cellnet.
6. Unlicensed limited area coverage systems.

40.20-3 TENANT DEVELOPMENT GUIDELINES

All tenants or lessees and other airport users shall comply with the DIA TDGs in connecting to or modifying the PWCS or installing, modifying or operating Radio/Wireless Communications Systems on the Airport.

40.20-4 DISCONNECTION

Any connection, modification, installation or operation of any telecommunications systems not in compliance with this section of the Rules and Regulations may/will be disconnected or shut down by the Manager at the Manager’s discretion. Such disconnection may occur without notice to the affected party if the non-complying system is interfering with other airport users’ systems or operations or is not labeled or identified sufficiently for notice to be given.

* * * * *

120.10 CHARGES FOR USE OF THE ANTENNA FARM (Revised January 1, 2003)

Effective October 1, 2002 all persons occupying space in the Antenna Farm site or utilizing the RF Distribution system at the airport, exclusively for their own business purposes, and not having other contractual arrangements with the City and County of Denver, shall pay the following annual rates:

Per Satellite Transmitter Dish	\$3,600
--------------------------------	---------

Per Antenna/Satellite on a Tower	\$1,200
Per Radio Cabinet	\$1,000
Per Geographic Positioning System (GPS)	\$300
Electricity (straight cost recovery-pro rata)	variable

If a tenant wishes to build its own facilities on the antenna farm site, Ground Rent at the Developed Rate will be assessed based on the square footage of the site.

* * * * *

Appendix F - DIA RF Application Process Flow Chart

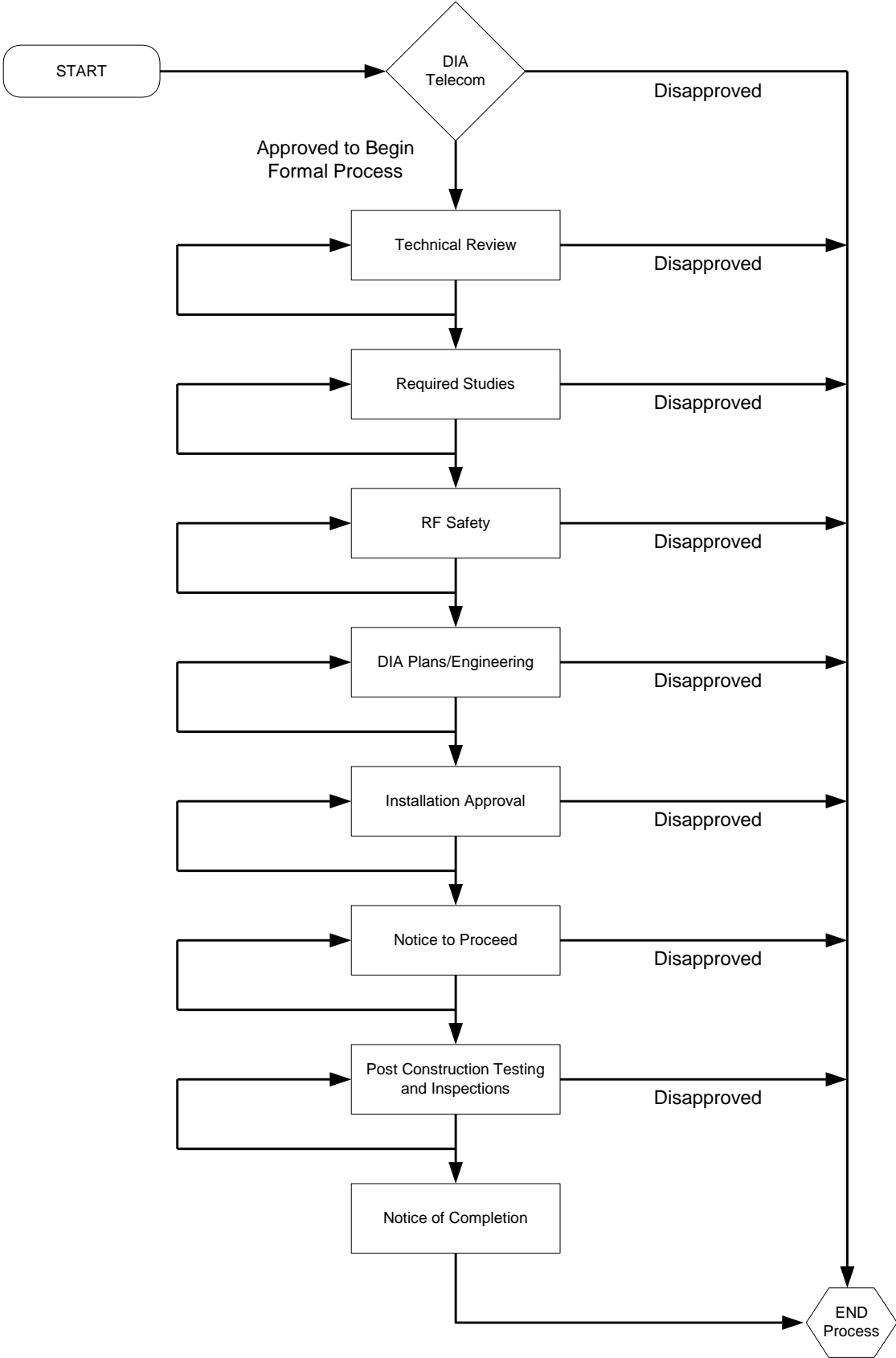

Exhibit X - Provisions for Design and Construction of Improvements

EXHIBIT X

PROVISIONS FOR DESIGN AND CONSTRUCTION OF IMPROVEMENTS

Section 1. General Requirements. As used below the term "Licensee" shall mean and include the "Party of the Second Part. Licensee, in conducting any activity on DEN property, shall comply with all applicable airport, local, state, and federal rules, regulations, statutes, laws, and orders (Environmental Requirements). In addition, these Environmental Requirements include applicable Environmental Guidelines developed for DEN's Environmental Management System (EMS), as summarized in DEN Rules and Regulations Part 180. DEN's Environmental Guidelines, Environmental Policy, and all Rules and Regulations are available at www.flydenver.com. These Environmental Requirements address, but are not limited to, requirements regarding the storage, use, and disposal of Hazardous Materials, solid and hazardous waste, or petroleum products; the National Environmental Policy Act (NEPA); and other federal, state, and local water, wastewater, and air quality regulations.

A. EMS: DEN's EMS has been certified to the ISO 14001 standard. DEN's EMS includes the above-noted airport-wide Environmental Policy and is designed around the significant aspects identified in DEN Rule and Regulation 180. It is a requirement of the standard that all entities providing products, goods, and/or services on behalf of DEN ensure that their personnel are aware of DEN's Environmental Policy, DEN's significant environmental aspects, and the specific environmental aspects and associated impacts for the products, goods, and/or services that will be provided by the Licensee,

B. Permits: Licensee shall acquire all necessary federal, state, local and airport permits/approvals and comply with all permit/approval requirements. Licensee shall prepare and update all plans and provide all information required by the City for regulatory compliance purposes and provide copies of all permit applications and permits to DEN.

C. Hazardous Materials Limited: Any hazardous materials not normally used in Licensee's operations are barred from DEN premises. Licensee shall identify all hazardous materials to be used at DEN along with a description of how these materials and any associated hazardous or other waste materials generated by Licensee will be managed while on airport property. This information is required prior to the Licensee conducting activities on DEN property.

D. MSDSs: Prior to operation, Licensee shall maintain copies of Material Safety Data Sheets (MSDSs) for all chemicals to be used in their activities, including those used for cleaning and maintenance. This obligation is continuing for the term of this Agreement, and Licensee shall make this documentation available for inspection by DEN upon request.

E. Pollution Prevention: Licensee is encouraged to utilize the concepts of pollution prevention, energy efficiency, and waste minimization with regard to its activities at DEN.

Section 2. Review of Environmental Documents. Licensee, at the request of the City, shall make available for inspection and copying, upon reasonable notice and at reasonable times, any or all of the documents and materials that the Licensee has prepared pursuant to any Environmental Requirement hereunder or submitted to any governmental or regulatory agency. If there is a requirement to file any notice or report of a release or threatened release of a

substance on, under or about the work conducted on DEN property, Licensee shall provide a copy of such report or notice to the City.

Section 3. Access for Environmental Inspection. The City shall have an unimpeded right of access to the occupancy or work areas without prior notice to Licensee to inspect the same in order to confirm that Licensee is conducting its activities in accordance with this Agreement. At the City's request, Licensee shall conduct any testing and analysis at its cost as is necessary to ascertain whether the Licensee is in compliance with this Agreement.

Section 4. Correction of Environmental Non-Compliance. If the Licensee fails to comply with any applicable Environmental Requirement, the City, in addition to its rights and remedies described elsewhere in this Agreement, at its election, may enter the facility and/or work area and take such measures as may be necessary to ensure compliance with the Environmental Requirements, all at the Licensee's expense.

Section 5. Duty to Notify City. In the event of a release or threatened release of a substance relating to or arising out of the Licensee's use or activities on DEN, or in the event any claim, demand, cause of action, or notice is made against the Licensee with regard to the Licensee's failure or alleged failure to comply with any requirement hereunder, the Licensee, immediately shall notify the City verbally by contacting the Airport Communications Center (303-342-4200) and the appropriate regulatory agency. Licensee shall immediately control and remediate the contaminated media and, as provided below, follow-up Licensee's verbal notice with a written report within three days of such incident. In addition, the Licensee shall provide the City, at Licensee's expense, with copies of any written claims, demands, notices or actions so made.

Section 6. Environmental Remediation. Licensee shall undertake all actions necessary to remedy or remove any released or spilled materials and any other contamination discovered on or under DEN property introduced by or affected by Licensee and shall restore the Access Premises to either its condition immediately prior to the initiation of this Agreement or to a condition in compliance with all applicable local, state, federal, or airport laws, rules, regulations, or orders, at the City's sole discretion. This work shall be performed at Licensee's expense and the City shall have the right to review the project plan and review and inspect all such work at any time using consultants and representatives of the City's choice. Licensee shall further conduct surface and subsurface monitoring pertaining to Licensee's activities hereunder to ensure compliance with applicable laws, rules, regulations, and permits or as determined by the CEO of Aviation.

Section 7. Environmental Requirements for Construction. Licensee agrees to ensure that its premises are designed, constructed, operated, and maintained in a manner that minimizes environmental impacts through application of appropriate preventive measures and complies with all federal, state, and local environmental requirements. Licensee shall comply with the DEN Development Guidelines, as amended, for any alterations to existing facilities or the construction of any new facilities. In addition, the Licensee shall comply with **Exhibit X** of this agreement.

SECTION 8. IMPROVEMENTS. "Improvements," shall mean any new construction, equipment, finishes, fixtures, systems, furnishings and furniture installed by Licensee, as well as modifications or alterations to existing construction, equipment, finishes, fixtures, systems, furnishings and furniture which conform to drawings and specifications approved in writing by the CEO. Such drawings and specifications must provide for the necessary and proper operation of the business contemplated under this Agreement.

SECTION 9. COMPLIANCE WITH LAWS AND REGULATIONS. Licensee agrees to comply with and require its contractors to comply with all applicable federal, state, and local laws and all general rules and regulations applicable to construction at DEN, including but not limited to payment of prevailing wages and sales and use taxes, compliance with the Americans with Disabilities Act, 42 USC 12,000 et seq. and its regulations.

In addition to the above, the Licensee and its contractors shall comply with all DEN specific rules and regulations regarding site access, use of site, safety, security, design, and construction and shall obtain and pay for all related permits. Failure to comply will be grounds for denial of access and/or suspension of construction activities. Regulations in force specific to DEN include but are not limited to the following:

The Denver Municipal Airport System Rules and Regulations

DEN Design Standards

DEN Development Guidelines

SECTION 10. PAYMENT OF PREVAILING WAGE RATES. Licensee shall require its contractor and all of its subcontractors to pay every worker, laborer or mechanic employed by them in the performance of the construction of the Improvements prevailing wages, including fringe benefits or their cash equivalent, for the same class and kind of work in the City and County of Denver, as determined by the Career Service Board under the provisions of Section 20-76 of the Denver Revised Municipal Code. The wages shall be those prevailing at the time of the contractor's final bid, and the Licensee shall require the contractor to submit with its bid the wage schedule applicable. The contractor shall post in a prominent and easily accessible place at the site of the Improvements the scale of wages to be paid by the contractor and all subcontractors at any tier working under the contractor. The contractor shall furnish to the Mayor's Office of Contract Compliance and to the Auditor, or the CEO's authorized representative, each week during which work is in progress, a true and correct copy of the payroll records of all workers employed to perform the work. All payroll records shall include information showing the number of hours worked by each worker, the hourly pay of such worker, any deductions made from pay, and the net amount of pay received by such worker for the period covered by the payroll. The payroll record shall be accompanied by a sworn statement of the contractor that the copy is a true and correct copy of the payroll records of all workers performing the work, either for the contractors or subcontractors, that payments were made to the workers as set forth in the payroll records, that no deductions were made other than those set forth in such records, and that all workers were paid the prevailing wages as of the contractor's final bid for the work. Compliance with above requirements shall be deemed a work "specification" as such word is used in Section 5-18(d), Denver Revised Municipal Code. Violation of the prevailing wage requirement and its documentation, hereinabove set forth, shall result in an order from the CEO of Aviation for the work to cease until there is satisfactory evidence that the violation has been remedied and will not reoccur. The issuance of a stop-work order shall not relieve contractor's surety of any liability

on contractor's bond or bonds, but the contractor shall deem such a stop-work order insofar as said surety's obligation is concerned.

SECTION 11. SBE AND MBE/WBE PARTICIPATION. This Agreement is subject to the requirements of Articles III and VII of the Denver Revised Municipal Code.

Licensee agrees that it shall provide for participation of Small Business Enterprises (SBEs) in the design and construction of Improvements, in compliance with Article VII, Division 1 of Chapter 28, Denver Revised Municipal Code (D.R.M.C.), or any successor ordinance effective at the time of any design and construction that Licensee may carry out during the life of this Agreement. The goal for percentage of design and construction work to be performed by SBE firms is set forth on the Construction Summary Page, and Licensee shall make a good faith effort to meet such goals as have been set in accordance with the ordinance. Further, the City and County of Denver encourages Licensees to utilize SBEs and to divide the design and construction work into economically feasible units or segments to allow the most opportunity for subcontracting.

Licensee agrees that it shall provide for participation of Minority Business Enterprises ("MBE") and Women Business Enterprises ("WBE") in the design and construction of Improvements, in compliance with the requirements of Article III, Divisions 1 and 3 of Chapter 28, of the Denver Revised Municipal Code ("MBE/WBE Ordinance"), or applicable successor ordinance, during the life of this Agreement. Licensee agrees to comply with rules and regulations issued by the Director of the Division of Small Business Opportunity ("DSBO"), a division of the Mayor's Office of Economic Development. The goal for percentage of design and construction work to be performed by MBE/WBE firms is set forth on the Construction Summary Page, and Licensee shall meet, or make a good faith effort to meet, such goals as have been set in accordance with the ordinance. Further, the City and County of Denver encourages Licensees to utilize MBE/WBE firms and to divide the design and construction work into economically feasible units or segments to allow the most opportunity for subcontracting.

SECTION 12. INSURANCE REQUIREMENTS. Refer to Appendix B of Manual 1 of the DEN Development Guidelines for insurance requirements for Licensee, Licensee's Design Consultants and Licensee's Contractors for required insurance coverage for design and construction of Improvements and completed Improvements, including requirements for submittal of certificates and renewals of insurance.

SECTION 13. EVIDENCE OF INSURANCE. Certified copies of required insurance policies, or certificates, in the standard form required, evidencing the existence thereof, or binders, shall be delivered to the DEN Division of Planning and Development at least 15 days prior to the commencement of any design work to be performed by Licensee's consultants and any construction work for Improvements. If a binder is delivered, it shall be replaced within 30 days by a certified copy of the policy or the required certificate. Policies shall be in a form and of a company acceptable to and approved by the City, and certificates shall be on standard City and County of Denver Certificate of Insurance forms.

Each such policy or certificate shall contain a valid provision or endorsement that the policy may not be canceled, terminated, changed or modified without 45 days prior written notice (10 days for nonpayment of premium) given by certified mail, return receipt requested, to the CEO of Aviation, 8500 Peña Boulevard, Denver, Colorado 80249-6340.

Each such policy or certificate shall further provide that any coverage afforded the City and County of Denver as an additional insured under the policy shall apply as primary insurance and any

other insurance issued to the City and County of Denver shall apply as excess and noncontributing insurance.

Any renewal certificate shall be delivered to the CEO of Aviation at least 10 days prior to the expiration of each expiring policy. If at any time, any of the insurance policies shall be or become unsatisfactory to the CEO of Aviation as to form or substance, or if any of the carriers issuing such policies shall be or become unsatisfactory to the CEO of Aviation, Licensee shall promptly obtain a new and satisfactory replacement policy.

SECTION 14. LIMITATION ON LIABILITY. Licensee agrees that no liability shall attach to the City for any damages or losses incurred or claimed by Licensee or any other person or party on account of the construction or installation of the Improvements or other Improvements to the Licensee's site made by the Licensee. Licensee agrees that no liability shall attach to the City for any interference or delay caused by construction in adjacent areas, travelers, other businesses, or airport operations, including without limitation damages or losses in the nature of delay damages, lost labor productivity, and impact damages. Licensee agrees to indemnify, defend and hold harmless the City from any loss, cost, damage or expense incurred, claimed, asserted or arising in connection with Licensee's or its contractors' or agents', construction or installation of the Improvements or other Improvements to the site made by the Licensee.

DESIGN PROVISIONS

SECTION 15. DESIGN PROCEDURES. Refer to Manual 1 of the DEN Development Guidelines for procedures and requirements regarding design, including but not limited to design process and schedule, submittal requirements, review and approval process, design modifications and project coordination.

Approval of the CEO of Aviation extends to and includes consideration of architectural, structural, mechanical, electrical, specialty systems, site, signage, landscaping and aesthetic matters, and DEN reserves the right to reject any design submitted and to require Licensee to resubmit designs and layout proposals until they meet with the approval of the CEO of Aviation. No substantial changes or alterations shall be made in said drawings or specifications after approval by the CEO of Aviation, and no alterations or improvements shall be made to or upon the Licensee's site without prior approval.

Licensee CADD Submittal Requirements: the Licensee shall provide all issue for construction and project record drawings to DEN in AutoCAD Rel. 2007 .dwg file format in accordance with DEN CADD standards set forth in Design Standards Manual 1. All design drawings submitted by the Licensee to the DEN shall be provided in the latest release of AutoCAD format in accordance with the DEN's Design Standards Manual.

Concession CADD Submittal Requirements: AutoCAD 2007 .dwg format CADD files that match the Licensee's hardcopy drawings must be submitted via: CD/ROM or DVD/ROM in MS-Windows format. All drawings must represent precision input and follow industry standard CADD practices. The drawings must reflect true design dimensioning and must NOT be graphic representations of the design. All site, civil and utility drawings MUST be produced using units in feet and the DEN Grid Coordinate System. The DEN Project Manager must approve submittal and may require adherence to the requirements set forth in DEN design standards.

In addition to the above, Licensee is responsible for coordination with the Denver Building Inspection Division, Zoning, Fire Department, Wastewater Management, Consumer Protection,

Health and Hospitals, etc. as may be required to comply with submittal, review and approval requirements in order to obtain all required permits. Prior to the issuance of a Notice to Proceed with Improvements from the CEO of Aviation, the Licensee shall obtain and pay for all approvals, licenses and permits required for the Improvements. Whenever a conflict arises between state or local law, ordinances or regulations and federal law or regulations, the most stringent law or regulations applicable to this Agreement shall control.

SECTION 16. DESIGN STANDARDS. First-class standards of design and construction are required, and all Improvements shall conform to applicable statutes, ordinances, building codes, and regulations as well as the DEN Design Standards and DEN Development Guidelines, as they may be amended from time to time and any other applicable design, construction and maintenance standards.

Approval of the CEO of Aviation shall extend to and include consideration of architectural and aesthetic matters and the City reserves the right to reject any designs submitted and to require the Licensee to resubmit designs and layout proposals until they meet with the City's approval. If any portion of the plans and specifications is disapproved by the City, the Licensee shall promptly submit necessary modifications and revisions thereof. The approval given by the CEO of Aviation shall not constitute a representation or warranty as to such conformity; therefore, responsibility remains with the Licensee at all times.

CONSTRUCTION PROVISIONS

SECTION 17. CONSTRUCTION PROCEDURES. Refer to Manual 1 of the DEN Development Guidelines for procedures and requirements regarding construction, including but not limited to construction schedule, submittal requirements, review and approval process, construction inspections, construction modifications and project coordination.

Compliance with standards: All construction work shall comply with the requirements of and standards established by the City and all other appropriate governmental agencies and entities. The City shall at all times have the right to monitor and inspect any construction to assure that the Improvements are constructed and installed in full compliance with the plans and specifications.

Standard of Performance: All work done by the Licensee or its contractors shall be done in a first-class workmanlike manner using only good grades of materials and shall comply with all insurance requirements and all applicable laws and ordinances and rules and regulations of governmental departments or agencies. Whenever a conflict arises between State or local law, ordinances or regulations and Federal law or regulations, Federal law or regulations applicable to this Agreement shall control.

City Inspection: All construction work, materials and installations involved in or incidental to the construction of the improvements undertaken by the Licensee throughout the term hereof shall be subject at all times to inspection and approval by the City. DEN shall at all times have the right of access to the construction site and to monitor and inspect the construction of all Improvements to insure that all Improvements are constructed and installed in compliance with approved drawings and specifications.

DEN shall have the right to halt construction of the Improvements or deny access to the site at any time if construction is at material variance from the approved drawings and specifications until such variance is corrected, or if such construction poses an immediate safety hazard at the

Airport, until such safety hazard is eliminated. The City shall cooperate and use its best efforts to alleviate and resolve any such variance or impediment to the safe operation of the Airport to permit continued construction as expeditiously as possible.

In order to assist DEN in monitoring and inspecting construction, the Licensee shall submit, or cause to be submitted for information and record, copies of all field test reports, certificates of insurance, waivers of liens, material certificates, shop drawings and submittals for review for compliance with DEN design and construction standards, contractor application for payment requests, construction progress reports, notification of substantial completion of Improvements and final acceptance, two copies of maintenance and operation manuals in connection with building systems and all updates thereof, as-built documents, and any other documents related to the construction of the Improvements which may be reasonably requested by DEN.

No change order or other contract modification that materially changes the scope of the Improvements shall be executed without prior approval of the CEO of Aviation, whose approval shall not be unreasonably withheld. The City will approve, conditionally approve or disapprove submissions of change orders that materially change the scope of the work within a reasonable period of time following receipt thereof. Any conditional approval or disapproval shall be accompanied by an explanation as to the reason for the condition.

The Building Inspection Division of the City and County of Denver shall also receive copies of all change orders. Any conditional approval or disapproval shall be accompanied by an explanation of the reasons.

Licensee is responsible for all temporary utilities required during construction. Licensee, at its sole cost and expense, shall obtain and make utility connections, hook-ups or taps as necessary or as stipulated in this Agreement, securing all necessary applications or permits and paying all associated fees. Licensee, at its sole cost and expense, shall provide meters, calibrated by the utility company, and maintain equipment as required to provide accurate measurement of usage and consumption. DEN makes no warranty as to the location of structures, wiring, fixtures, or systems, and Licensee accepts them on an "as is" basis without further recourse against DEN as to their location, number, or suitability for the particular purposes of the Licensee.

Licensee is responsible for maintaining a clean, orderly, and safe construction site, free of accumulated construction debris and waste materials and shall be responsible for legal removal of same. Construction shall be accomplished without interfering with travelers, airport operations or other businesses, providing barricades and/or construction enclosures as required.

SECTION 18. CONSTRUCTION BONDS AND PERMITS. Prior to Notice to Proceed with construction Improvements, Licensee and its contractor shall deliver to the CEO of Aviation performance and payment bonds and copies of all required permits, licenses and all other documents as required by Manual 1 of the DEN Development Guidelines.

SECTION 19. MODIFICATIONS AND ALTERATIONS. Modifications and alterations to existing Licensee improvements are subject to the same requirements and provisions as new Licensee improvements as itemized in this *Exhibit X* and this Agreement.

Advance Notice of Modification: The Licensee shall give or cause to be given to the City advance notice before performing any material modification to the improvements.

Expense of Alterations. Any work necessary to make any alterations, improvements, or additions to the facility throughout the term of this Agreement shall be done at the Licensee's cost and expense, in accordance with and subject to all of the required approvals, submittals, and procedures, and all other requirements of whatsoever nature, as set forth herein.

SECTION 20. AS-BUILT DOCUMENTS. Not later than 60 days after completion of all work for the Improvements, Licensee shall provide DEN two complete sets of as-built documents prepared in accordance with DEN requirements. If Licensee fails to provide as-built documents after written notice from DEN, DEN may elect to have the documents completed and charge the Licensee for the costs associated therewith. Licensee agrees that, upon the request of DEN, Licensee will inspect the Improvements jointly with DEN to verify as-built documents.

Exhibit Z - City's Form of Insurance Certificate

II. ADDITIONAL COVERAGE

Excess/Umbrella Liability

Minimum Limits of Liability (In Thousands):

Umbrella Liability Controlled Area	Each Occurrence and aggregate	\$9,000
Umbrella Liability Non-Controlled Area	Each Occurrence and aggregate	\$1,000

The policy must provide the following:

1. Coverage must be written on a "follow form" or broader basis.
2. Any combination of primary and excess coverage may be used to achieve required limits.
3. If operations include unescorted airside access at DIA, then a \$9 million Umbrella Limit is required.

Technology Errors & Omissions

Minimum Limits of Liability (In Thousands)

Per Occurrence	\$1,000
Aggregate	\$1,000

The policy must provide the following:

1. Liability arising from theft, dissemination and / or use of confidential information (a defined term including but not limited to bank account, credit card account, personal information such as name, address, social security numbers, etc. information) stored or transmitted in electronic form.
2. Liability arising from the introduction of a computer virus into, or otherwise causing damage to, a customer's or third person's computer, computer system, network or similar computer related property and the data, software, and programs thereon.
3. Policies written on a claims made basis must remain in full force and effect in accordance with CRS 13-80-104. The Insured warrants that any retroactive date under the policy shall precede the effective date of this Contract; and that either continuous coverage will be maintained or an extended discovery period will be exercised for a period of three (3) years beginning at the time work under the Contract is completed.
4. Coverage for advertising injury, personal injury (including invasion of privacy) and intellectual property offenses related to internet.

III. ADDITIONAL CONDITIONS

It is understood and agreed, for the benefit of the City, that the following additional conditions shall apply to all coverage specified herein:

1. For Commercial General Liability, Auto Liability and Excess Liability/Umbrella (if required), Contractor and subcontractor's insurer(s) shall include the City and County of Denver, its elected and appointed officials, employees and volunteers as additional insured.
2. All coverage provided herein shall be primary and any insurance maintained by the City shall be considered excess.
3. For all coverages required under this Agreement, Contractor's insurer shall waive subrogation rights against the City.
4. The City shall have the right to verify or confirm, at any time, all coverage, information or representations contained herein, and the insured and its undersigned agent shall promptly and fully cooperate in any such audit the City may elect to undertake.
5. The required insurance shall be underwritten by an insurer licensed or authorized to do business in Colorado and rated by A.M. Best Company as "A-"VIII or better.
6. For claims-made coverage, the retroactive date must be on or before the contract date or the first date when any goods or services were provided to the City, whichever is earlier
7. No changes, modifications or interlineations on this document shall be allowed without the review and approval of the Risk Administrator prior to contract execution.

NOTICE OF CANCELLATION

It is understood and agreed that should any Policy issued hereunder be cancelled or non-renewed before the expiration date thereof, or sustain a material change in coverage adverse to the City, the issuing company or its authorized Agent shall give notice to the Department of Aviation in accordance with policy provisions.

Appendix A - E (Standard Federal Assurances)

APPENDIX A

COMPLIANCE WITH NONDISCRIMINATION REQUIREMENTS

NOTE: As used below the term "Contractor" shall mean and include Concessionaire, and the term "sponsor" shall mean the "City."

During the term of this Contract, the Contractor, for itself, its assignees and successors in interest (hereinafter referred to as the "Contractor") agrees as follows:

1. **Compliance with Regulations.** The Contractor will comply with the Title VI List of Pertinent Non-Discrimination Statutes and Authorities, as they may be amended from time to time, which are herein incorporated by reference and made part of this Agreement.

2. **Nondiscrimination.** The Contractor, with regard to the work performed by it during this Agreement, will not discriminate on the grounds of race, creed, color, national origin, or sex in the selection and retention of subcontractors, including procurements of materials and leases of equipment. The Contractor will not participate directly or indirectly in the discrimination prohibited by the Acts and Regulations, including employment practices when the Agreement covers any activity, project, or program set forth in Appendix B of 49 CFR Part 21.

3. **Solicitations for Subcontractors, Including Procurements of Materials and Equipment.** In all solicitations, either by competitive bidding or negotiation, made by the Contractor for work to be performed under a subcontract, including procurements of materials or leases of equipment, each potential subcontractor or supplier will be notified by the Contractor of the Contractor's obligations under this Agreement and the Acts and Regulations relative to nondiscrimination on the grounds of race, color, or national origin.

4. **Information and Reports.** The Contractor will provide all information and reports required by the Acts, Regulations, or directives issued pursuant thereto and will permit access to its books, records, accounts other sources of information, and its facilities as may be determined by the sponsor or the Federal Aviation Administration (FAA) to be pertinent to ascertain compliance with such Acts, Regulations, and instructions. Where any information required of a Contractor is in the exclusive possession of another who fails or refuses to furnish this information, the Contractor shall so certify to the sponsor or the FAA, as appropriate, and will set forth what efforts it has made to obtain the information.

5. **Sanctions for Noncompliance.** In the event of a Contractor's noncompliance with the nondiscrimination provisions of this Agreement, the sponsor will impose such Contract sanctions as it or the FAA may determine to be appropriate including, but not limited to:

- a. Withholding of payments to the Contractor under this Agreement until the Contractor complies; and/or
- b. Cancelling, terminating, or suspending this Agreement, in whole or in part.

6. **Incorporation of Provisions.** The Contractor will include the provisions of paragraphs one (1) through six (6) in every subcontract, including procurements of materials and leases of equipment, unless exempt by the Acts, the Regulations or directives issued pursuant thereto. The Contractor will take action with respect to any subcontract or procurement as the sponsor or the FAA may direct as a means of enforcing such provisions including sanctions for noncompliance. Provided, that if the Contractor becomes involved in, or is threatened with litigation by a subcontractor, or supplier because of such direction, the Contractor

may request the sponsor to enter into such litigation to protect the interests of the sponsor. In addition, the Contractor may request the United States to enter into such litigation to protect the interests of the United States.

APPENDIX C

STANDARD FEDERAL ASSURANCES AND NONDISCRIMINATION IN CONSTRUCTION, MAINTENANCE, OPERATION OF FACILITIES

As used below, the term “sponsor” will mean City.

Concessionaire, for himself/herself, his/her heirs, personal representatives, successors in interest, and assigns, as part of consideration hereof, does hereby covenant and agree, as a covenant running with the land that:

1. In the event facilities are constructed, maintained, or otherwise operated on the property described in this Agreement for a purpose for which a FAA activity, facility, or program is extended or for another purpose involving the provision of similar services or benefits, the Concessionaire will maintain and operate such facilities and services in compliance with all requirements imposed by the Nondiscrimination Acts and Regulations listed in the Pertinent List of Nondiscrimination Authorities, as may be amended from time to time, such that no person on the grounds of race, color, or national origin, will be excluded from participation in, denied the benefits of, or be otherwise subjected to discrimination in the use of said facilities.
2. With respect to this Agreement, in the event of breach of any of the above Nondiscrimination covenants, sponsor will have the right to terminate this Agreement, and to enter, re-enter, and repossess said lands and facilities thereon, and hold the same as if this Agreement had never been made or issued.

APPENDIX D

STANDARD FEDERAL ASSURANCES AND NONDISCRIMINATION IN CONSTRUCTION, USE, OR ACCESS TO FACILITIES

As used below, the term "sponsor" will mean City.

- A. Concessionaire for himself/herself, his/her heirs, personal representatives, successors in interest, and assigns, as part of the consideration hereof, does hereby covenant and agree, as a covenant running with the land, that (1) no person on the ground of race, color, or national origin, will be excluded from participation in, denied the benefits of, or be otherwise subjected to discrimination in the use of said facilities, (2) that in the construction of any improvements on, over, or under such land, and the furnishing of services thereon, no person on the ground of race, color, or national origin, will be excluded from participation in, denied the benefits of, or otherwise be subjected to discrimination, (3) that the Concessionaire will use the Premises in compliance with all other requirements imposed by or pursuant to the List of Pertinent Nondiscrimination Authorities.

- B. With respect this Agreement, in the event of breach of any of the above nondiscrimination covenants, sponsor will have the right to terminate this Agreement and to enter, re-enter, and repossess said land and the facilities thereon, and hold the same as if this Agreement had never been made or issued.

APPENDIX E

TITLE VI LIST OF PERTINENT NONDISCRIMINATION AUTHORITIES

As used below, the term "Contractor" will mean and include Concessionaire and the term "sponsor" will mean City.

During the performance of this Agreement, the Contractor, for itself, its assignees, and successors in interest (hereinafter referred to as the "Contractor") agrees to comply with the following nondiscrimination statutes and authorities; including but not limited to:

- Title VI of the Civil Rights Act of 1964 (42 U.S.C. § 2000d *et seq.*, 78 stat. 252), (prohibits' discrimination on the basis of race, color, national origin);
- 49 CFR part 21 (Non-discrimination In Federally-Assisted Programs of The Department of Transportation-Effectuation of Title VI of The Civil Rights Act of 1964);
- The Uniform Relocation Assistance and Real Property Acquisition Policies Act of 1970, (42 U.S.C. § 4601), (prohibits unfair treatment of persons displaced or whose property has been acquired because of Federal or Federal-aid programs and projects);
- Section 504 of the Rehabilitation Act of 1973, (29 U.S. C. § 794 *et seq.*), as amended, (prohibits discrimination on the basis of disability); and 49 CFR part 27;
- The Age Discrimination Act of 1975, as amended, (42 U.S.C. § 6101 *et seq.*), (prohibits discrimination on the basis of age);
- Airport and Airway Improvement Act of 1982, (49 USC§ 471, Section 47123), as amended, (prohibits discrimination based on race, creed, color, national origin, or sex);
- The Civil Rights Restoration Act of 1987, (PL 100-209), (Broadened the scope, coverage and applicability of Title VI of the Civil Rights Act of 1964, The Age Discrimination Act of 1975 and Section 504 of the Rehabilitation Act of 1973, by expanding the definition of the terms "programs or activities" to include all of the programs or activities of the Federal-aid recipients, sub-recipients and Contractors, whether such programs or activities are Federally funded or not);
- Titles II and III of the Americans with Disabilities Act of 1990, which prohibit discrimination on the basis of disability in the operation of public entities, public and private transportation systems, places of public accommodation, and certain testing entities (42 U.S.C. §§ 12131 -12189) as implemented by Department of Transportation regulations at 49 CFR parts 37 and 38;
- The Federal Aviation Administration's Non-discrimination statute (49 U.S.C. § 47123) (prohibits discrimination on the basis of race, color, national origin, and sex);
- Executive Order 12898, Federal Actions to Address Environmental Justice in Minority Populations and Low-Income Populations, which ensures discrimination against minority populations by discouraging programs, policies, and activities with disproportionately high and adverse human health or environmental effects on minority and low-income populations;

- Executive Order 13166, Improving Access to Services for Persons with Limited English Proficiency, and resulting agency guidance, national origin discrimination includes discrimination because of limited English proficiency (LEP). To ensure compliance with Title VI, you must take reasonable steps to ensure that LEP persons have meaningful access to your programs (70 Fed. Reg. at 74087 to 74100);
- Title IX of the Education Amendments of 1972, as amended, which prohibits you from discriminating because of sex in education programs or activities (20 U.S. C. 1681 et seq).